

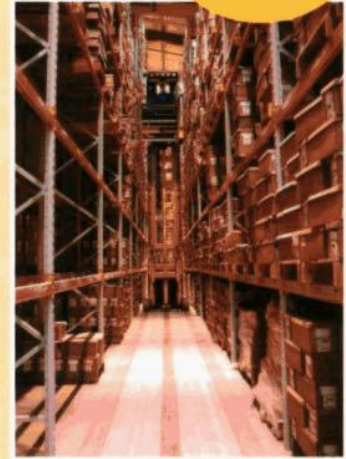

Technical Report No. **34**
Third Edition



Concrete industrial ground floors

A guide to design and construction

Report of a Concrete Society
Working Party

dti

ACIFC

Concrete industrial ground floors

A guide to design and construction

Third Edition

Concrete industrial ground floors – A guide to design and construction

Concrete Society Technical Report No. 34

Third Edition

ISBN 1 904482 01 5

© The Concrete Society 1988, 1994, 2003

Published by The Concrete Society, 2003

Reprinted 2004, 2007 by Cromwell Press, Trowbridge, UK.

Further copies and information about membership of The Concrete Society may be obtained from:

The Concrete Society

Riverside House

4 Meadows Business Park

Station Approach

Blackwater, Camberley

Surrey

GU17 9AB

Tel: +44 (0)1276 607140, Fax: +44(0)1276 607141

E-mail: enquiries@concrete.org.uk, www.concrete.org.uk

Design and layout by Jon Webb

Index compiled by Linda Sutherland

All rights reserved. Except as permitted under current legislation no part of this work may be photocopied, stored in a retrieval system, published, performed in public, adapted, broadcast, transmitted, recorded or reproduced in any form or by any means, without the prior permission of the copyright owner. Enquiries should be addressed to The Concrete Society.

The recommendations contained herein are intended only as a general guide and, before being used in connection with any report or specification, they should be reviewed with regard to the full circumstances of such use. Although every care has been taken in the preparation of this Report, no liability for negligence or otherwise can be accepted by The Concrete Society, the members of its working parties, its servants or agents.

Concrete Society publications are subject to revision from time to time and readers should ensure that they in possession of the latest version.

Concrete industrial ground floors

A guide to design and construction

Report of a Concrete Society Working Party

The Concrete Society

CONTENTS

List of figures	viii	4.4 Surface regularity in defined-movement areas	23
List of tables	ix	4.5 Survey practice for all floor types	25
Members of the Project Committees	x	4.6 Change of floor flatness with time	25
Acknowledgements	xi	4.7 Converting floors to defined-movement specifications	25
Preface	xii		
Glossary of terms and abbreviations	xiii		
1 INTRODUCTION	1	5 FLOOR SURFACE REQUIREMENTS	27
1.1 Scope	1	5.1 Introduction	27
1.2 Structure of the report	2	5.2 Abrasion resistance	27
1.3 Procurement methods	3	5.3 Chemical resistance	27
1.4 Innovations in floor technology	3	5.4 Colour and appearance	28
1.5 Implications of new design recommendations	5	5.5 Cracking	28
		5.6 Cracking	28
		5.7 Curling	28
		5.8 Delamination	29
		5.9 Slip resistance	29
		5.10 Surface aggregate	29
		5.11 Surface fibres	29
		5.12 Surface finish marks	30
PART ONE		PART TWO	
OPERATING REQUIREMENTS	7	DESIGN ASPECTS	31
2 OVERVIEW OF FLOOR CONSTRUCTION	9	6 SOILS, SUB-BASES AND MEMBRANES	33
2.1 Introduction	9	6.1 Introduction	33
2.2 Floor construction methods	9	6.2 Design models for soils	33
2.2.1 Large area construction – jointed	9	6.2.1 Introduction	33
2.2.2 Large area construction – jointless	10	6.2.2 The Winkler model	33
2.2.3 Long strip construction	10	6.3 Subgrades	33
2.2.4 Wide bay construction	11	6.3.1 Design considerations	33
2.2.5 Two-layer construction	11	6.3.2 Soil surveys	34
2.3 Cold stores	11	6.3.3 Subgrade construction	34
2.4 Pile-supported floors	11	6.3.4 Imported fill and ground improvement	35
		6.4 Sub-bases	35
		6.4.1 General	35
		6.4.2 Sub-base top surface tolerances	35
		6.5 Membranes	36
3 FLOOR LOADINGS	12	7 REINFORCEMENT	37
3.1 Static loads	12	7.1 Introduction	37
3.1.1 Introduction	12	7.2 Steel reinforcement bar	37
3.1.2 Uniformly distributed loads	12	7.3 Steel fabric	37
3.1.3 Line loads	13	7.4 Steel fibres	38
3.1.4 Point loads	13	7.5 Structural synthetic fibres	39
3.2 Materials handling equipment	16	7.6 Reinforcement spacers and chairs	39
3.2.1 Introduction	16		
3.2.2 MHE operating at floor level	16		
3.2.3 MHE operating in free-movement areas and wide aisles	16		
3.2.4 MHE operating in very narrow aisles	17		
3.3 Classification of floor loadings	17		
4 SURFACE REGULARITY	19		
4.1 Introduction: the importance of surface regularity	19		
4.2 Floor types: free and defined movement	20		
4.3 Surface regularity in free-movement areas	22		

8 JOINTS	40	9.4.3 Synthetic-fibre-reinforced concrete	52
8.1 Introduction	40	9.4.4 Steel fabric and bar	52
8.2 Joint types	40	9.4.5 Modulus of subgrade reaction	53
8.3 Free-movement joints	40	9.4.6 Radius of relative stiffness	53
8.3.1 Purpose	40	9.5 Actions (loads)	53
8.3.2 Sawn free-movement joints	40	9.6 Partial safety factors	54
8.3.3 Formed free-movement joints	41	9.6.1 General	54
8.3.4 Wire guidance systems	41	9.6.2 Partial safety factors for materials	54
8.3.5 Expansion joints	41	9.6.3 Partial safety factors for actions	54
8.4 Restrained-movement joints	41	9.7 Yield line theory	55
8.4.1 Purpose	41	9.7.1 Basic approach for point loads	55
8.4.2 Sawn restrained-movement joints	42	9.7.2 Development of analyses for ground-supported slabs	55
8.4.3 Formed restrained-movement joints	42	9.8 Design moment capacities	56
8.5 Tied joints	42	9.8.1 Steel-fibre-reinforced concrete	56
8.6 Isolation details	42	9.8.2 Synthetic-fibre-reinforced concrete	56
8.7 Performance of sawn and formed joints	42	9.8.3 Reinforced concrete (bar and fabric)	56
8.8 Load-transfer mechanisms	44	9.9 Design equations	56
8.8.1 Introduction	44	9.9.1 Introduction	56
8.8.2 Aggregate interlock	44	9.9.2 Load locations	56
8.8.3 Steel-fibre-reinforced concrete	45	9.9.3 Point loads	57
8.8.4 Round and square dowels	45	9.9.4 Multiple point loads	58
8.8.5 Steel fabric reinforcement	45	9.9.5 Line loads and uniformly distributed loads	58
8.8.6 Proprietary systems	45	9.10 Calculation of load transfer	60
8.9 Armouring of joints	45	9.10.1 Load transfer by dowels	60
8.9.1 Introduction	45	9.10.2 Load transfer by fabric	62
8.9.2 Anchorage fittings	46	9.10.3 Load transfer by proprietary systems	62
8.9.3 Ease of construction	46	9.11 Punching shear	62
8.9.4 Shrinkage along joints	46	9.11.1 Introduction	62
8.10 Joint layout	46	9.11.2 Shear at the face of the loaded area	62
8.10.1 Joint spacing and detailing	46	9.11.3 Shear on the critical perimeter	63
8.10.2 Joint spacing and reinforcement	46	9.12 Checks for serviceability	63
8.10.3 Jointless construction	47	9.12.1 Overview	63
8.11 Joints in cold stores	47	9.12.2 Deflection control	63
8.12 Joint sealants	48	9.12.3 Movements	64
8.12.1 Introduction	48		
8.12.2 Joints in new floors	48		
8.12.3 Sealant application	48		
8.12.4 Other filling systems	49		
8.12.5 Maintaining joints	49		
9 STRENGTH AND SERVICEABILITY OF SLABS	50	PART THREE	
Symbols	50	CONCRETE PERFORMANCE AND COMPONENT MATERIALS	67
9.1 Introduction	51	10 CONCRETE PERFORMANCE	69
9.2 Units	51	10.1 Specification considerations	69
9.3 Design principles and criteria	51	10.2 Strength and related characteristics	69
9.3.1 Introduction	51	10.2.1 Compressive and flexural strength	69
9.3.2 Ultimate limit state	51	10.2.2 Ductility of fibre-reinforced concrete	69
9.3.3 Serviceability	52	10.2.3 Maturity of concrete in cold store floors	69
9.4 Material properties	52	10.3 Shrinkage	69
9.4.1 Concrete	52	10.3.1 Introduction	69
9.4.2 Steel-fibre-reinforced concrete	52	10.3.2 Drying shrinkage	70
		10.3.3 Early thermal contraction	70
		10.3.4 Cracking	71

10.3.5 Plastic shrinkage	71
10.4 Mix design for placing and finishing	71
10.5 Abrasion resistance	72
10.6 Chemical resistance	72

11 CONCRETE COMPONENTS 74

11.1 Cement	74
11.1.1 Common cements and combinations	74
11.1.2 Choice of cement / cement combination	74
11.1.3 Expansive cements	75
11.2 Aggregates	75
11.2.1 Introduction	75
11.2.2 Mechanical performance	75
11.2.3 Drying shrinkage of aggregates	75
11.3 Admixtures	75
11.3.1 Introduction	75
11.3.2 High-range water-reducing admixtures	76
11.3.3 Normal water-reducing admixtures and retarding admixtures	76
11.3.4 Accelerating admixtures	76
11.3.5 Shrinkage-reducing admixtures	76
11.3.6 Air-entraining admixtures	76
11.3.7 Concrete production with admixtures	76
11.4 Dry shake finishes	76
11.5 Steel fibres	77
11.6 Synthetic fibres	77
11.6.1 Introduction	77
11.6.2 Effect of microfibres on hardened concrete	77

PART FOUR BEST PRACTICE IN CONSTRUCTION AND MAINTENANCE. 79

12 FRAMEWORK FOR GOOD SITE PRACTICE 81

12.1 Introduction	81
12.2 Health and safety	81
12.3 Pre-construction planning	81
12.4 Construction	82
12.5 Protection of the new floor	82
12.6 Post-construction	83

13 MAINTENANCE 84

13.1 Introduction	84
13.2 Cleaning	84
13.3 Surface wear – abrasion	84
13.4 Surface wear – scouring and impact damage	84
13.5 Joints	84
13.6 Cracks	85

References 86

APPENDIX A

Model design brief	90
------------------------------	-----------

APPENDIX B

Worked example: Thickness design of a ground-supported floor slab 92

B1 Introduction	92
B2 Design data	92
B3 Zone A: racking	93
B4 Zone B: general storage/display	94
B5 Zone C: internal wall (line load)	94
B6 Zone D: mezzanine	94
B7 Materials handling equipment	95
B8 Relative position of truck wheel and racking leg	95
B9 Deflection check	95

APPENDIX C

Floor regularity. 97

C1 Developments in floor surveying	97
C2 Alternative method for surveying defined-movement areas	97
C3 Application of truck dimensions	100
C4 Specifications outside the UK	100

APPENDIX D

Pile-supported slabs. 101

D1 Introduction	101
D2 Alternative design approaches	101
D3 Structural analysis	101
D4 Section analysis	101
D4.1 Bar- or fabric-reinforced slab	101
D4.2 Steel-fibre-reinforced slab	101
D4.3 Punching shear	102
D4.4 Serviceability	102
D5 Joints in piled slabs	102
D5.1 Introduction	102
D5.2 Tied joints	102
D5.3 Formed free-movement joints	102

APPENDIX E

Design with steel fabric reinforcement 103

E1 Supplement to Chapter 9, strength and serviceability of slabs	103
E2 Extension to Appendix B, thickness design of a ground-supported floor slab	103
E2.1 Zone A: Racking – Ultimate limit state	103
E2.2 Materials handling equipment	104
E2.3 Relative position of fork-lift truck and racking leg	104

APPENDIX F

Sources of information 105

Sponsor profiles 107

Subject index 135

LIST OF FIGURES

- Figure 1.1 Low-level operation in which pallets are handled by a counterbalance truck. *page 1*
- Figure 1.2 A reach truck with a telescopic mast between wide aisle racking. *page 1*
- Figure 1.3 A transfer aisle in a large distribution warehouse. Goods are stored in high racking (right) and deposited at the ends of the aisles. Counterbalance trucks then assemble the goods in the collation area for onward distribution. *page 2*
- Figure 1.4 The concrete floor in this factory provides a durable platform designed to withstand wear and tear from the materials handling equipment and the products. *page 2*
- Figure 1.5 The floor in this DIY retail store provides an attractive surface. A dry shake finish has been used. *page 2*
- Figure 2.1 Typical slab construction. *page 10*
- Figure 2.2 Large area construction. In the background (left) a laser screed machine is spreading and levelling the concrete. To the right a dry shake finish is being spread mechanically. In the foreground, the concrete placed several hours earlier is being finished by a power float and a ride-on power trowel. *page 10*
- Figure 2.3 Long strip construction, allowing access for levelling using a highway straightedge. *page 10*
- Figure 2.4 Typical construction layers in cold stores. *page 11*
- Figure 3.1 Block stacking of unit loads. *page 12*
- Figure 3.2 Rolls of paper are considered as unit loads. Note the heavy-duty dual-wheeled lift truck. *page 12*
- Figure 3.3 Back-to-back storage racking with 'man-up' stacker trucks operating in narrow aisles. Pallets are deposited at the ends of the racking for collection. *page 13*
- Figure 3.4 Typical 'back-to-back' configuration of storage racking. *page 14*
- Figure 3.5 Mobile pallet racking. *page 14*
- Figure 3.6 Live storage systems. *page 14*
- Figure 3.7 Drive-in racking. *page 14*
- Figure 3.8 Push-back racking. *page 15*
- Figure 3.9 Cantilever racking. *page 15*
- Figure 3.10 Mezzanine (raised platform). *page 15*
- Figure 3.11 Mezzanine used for access to storage, with racking below. *page 15*
- Figure 3.12 Clad rack system. *page 15*
- Figure 3.13 The small wheels on pallet trucks (such as that in the foreground) can be damaging to joints in floors. *page 16*
- Figure 3.14 Counterbalance truck. *page 17*
- Figure 3.15 'Man-up' stacker truck in a very narrow aisle warehouse. *page 17*
- Figure 3.16 Stacker crane, running on a floor-mounted rail. *page 18*
- Figure 4.1 Surface profiles. *page 19*
- Figure 4.2 Flatness and levelness. *page 19*
- Figure 4.3 Examples of measurements of Property I over 300 mm and the resultant determination of change in elevational difference over a distance of 300 mm (Property II). *page 19*
- Figure 4.4 A free-movement area: marks from the rubber tyres of the materials handling equipment may be seen. *page 21*
- Figure 4.5 A defined-movement area in a very narrow aisle. *page 21*
- Figure 4.6 Static lean. *page 21*
- Figure 4.7 Floor surveying equipment. *page 22*
- Figure 4.8 Profileograph in use in an aisle. *page 24*
- Figure 4.9 Remediation in wheel tracks. *page 24*
- Figure 4.10 Typical grinding operations. *page 25*
- Figure 6.1 Conversion factors for different loading plate sizes. *page 34*
- Figure 6.2 Relationship between modulus of subgrade reaction and in situ CBR. *page 34*
- Figure 6.3 Proof loading of sub-base for construction traffic with concrete truck. *page 35*
- Figure 7.1 Dock levellers. Additional reinforcement may be needed in the areas around each entrance. *page 37*
- Figure 7.2 Typical load-deflection graph for steel-fibre-reinforced concrete beams. *page 38*
- Figure 8.1 Sawn free-movement joint. *page 40*
- Figure 8.2 Formed free-movement joints with various load-transfer and aris-protection systems. *page 41*
- Figure 8.3 Sawn restrained-movement joint (shown with fabric). *page 42*
- Figure 8.4 Formed restrained-movement joint. *page 42*
- Figure 8.5 Tied joint. *page 42*
- Figure 8.6 Isolation details around column. *page 43*
- Figure 8.7 Slab isolation details at slab perimeter and columns. *page 43*
- Figure 8.8 Joint sawing. *page 43*
- Figure 8.9 Suggested mechanism of crack inducement. *page 43*
- Figure 8.10 Concrete integrity and levels at sawn and formed joints. *page 44*
- Figure 8.11 Permanent formwork, with dowel bars in place, for a formed restrained-movement joint in a long strip construction. The walls and columns are protected with polythene. *page 47*
- Figure 9.1 Approximate distribution of bending moments for an internal load. *page 53*
- Figure 9.2 Development of radial and circumferential cracks in a concrete ground-supported slab. *page 55*
- Figure 9.3 Definitions of loading locations. *page 56*
- Figure 9.4 Calculation of equivalent contact area for two adjacent point loads. *page 57*
- Figure 9.5 Adjacent point loads in very narrow aisles. *page 57*
- Figure 9.6 Yield line patterns for multiple point loads. *page 58*
- Figure 9.7 Use of Hetenyi's equations for a line load P . *page 59*
- Figure 9.8 Loading patterns for uniformly distributed load, w , causing maximum positive bending moment (upper drawing) and maximum negative bending moment (lower drawing). *page 59*
- Figure 9.9 Defined areas of uniformly distributed load. *page 60*
- Figure 9.10 Behaviour of dowels. *page 60*
- Figure 9.11 Critical perimeters for punching shear for internal, edge and corner loading. *page 62*
- Figure 9.12 Typical load-deflection relationship for steel-fibre-reinforced ground-supported slab. *page 63*
- Figure 12.1 A well-laid sub-base is providing a sound platform for construction operations. Fabric is placed just ahead of the laser screed machine so it is not displaced by this mobile plant. The building is almost completely enclosed. *page 81*
- Figure 12.2 Successfully completed floor. *page 82*
- Figure 12.3 The edge of the previous pour (foreground) is protected by matting, which allows hand finishing of the edge of the new slab to be done easily and minimises the risk of splashes of wet concrete spoiling the appearance of the cast slab. *page 83*
- Figure B1 Plan of warehouse (not to scale). *page 92*
- Figure B2 Punching shear perimeter at edge. *page 93*
- Figure B3 Arrangement of loads for maximum hogging moment. *page 94*
- Figure B4 Arrangement of mezzanine baseplate grid. *page 94*
- Figure B5 Equivalent loaded areas for racking legs and fork-lift truck wheels. *page 95*
- Figure C1 Survey method. *page 98*
- Figure C2 Surveying a planned defined-movement area with a profileograph prior to installation of racking. *page 98*
- Figure C3 Property B ($= d_2 - d_1$). *page 98*
- Figure C4 Property D ($= d_2 - d_1$). *page 98*
- Figure D1 Cross-sections of typical piled slabs (not to scale). *page 101*
- Figure D2 Stress blocks for concrete with steel fibres and/or reinforcement in flexure at the ultimate limit state. *page 102*

LIST OF TABLES

Table 3.1	Descriptions of load types and examples. <i>page 12</i>	Table 9.5	Maximum load per dowel (kN) to avoid bursting (punching) of slabs. <i>page 62</i>
Table 4.1	Definition of surface regularity terms. <i>page 20</i>	Table 9.6	Typical deflections for 20 mm round dowel. <i>page 62</i>
Table 4.2	Permissible limits on Properties II and IV in free-movement areas. <i>page 22</i>	Table 9.7	Values of load-transfer capacity, $P_{app, fab}$, based on Equations 9.23 to 9.26, and using $f_y = 460 \text{ N/mm}^2$, $\gamma_s = 1.05$, and $x = 2.0 \text{ mm}$. <i>page 62</i>
Table 4.3	Permissible limits on Properties I, II and III in defined-movement areas. <i>page 24</i>	Table 9.8	Values of deflection coefficient c for corner loading. <i>page 64</i>
Table 4.4	Permissible limits on Properties II and IV in FM 2 floors for possible conversion to Category 1. <i>page 26</i>	Table 9.9	Influence of k on deflection of typical slab under a point load of 60 kN. <i>page 64</i>
Table 5.1	Performance classes for abrasion resistance, based on Table 4 of BS 8204-2: 2002. <i>page 27</i>	Table 9.10	Typical periods over which movements occur. <i>page 64</i>
Table 6.1	Error in slab thickness design resulting from error in estimation of modulus of subgrade reaction k . <i>page 33</i>	Table 10.1	Approximate coefficient of linear thermal expansion of concrete made with various aggregates. <i>page 70</i>
Table 6.2	Typical values of modulus of subgrade reaction k related to soil type. <i>page 34</i>	Table 10.2	Factors affecting abrasion resistance of concrete floors. <i>page 73</i>
Table 8.1	Sealant types and properties. <i>page 48</i>	Table 11.1	Effects of different cements and combinations on concrete properties. <i>page 74</i>
Table 9.1	Strength properties for concrete. <i>page 52</i>	Table A1	Model design brief for concrete industrial ground floors <i>page 90, 91</i>
Table 9.2	Dimensions of standard square fabrics. <i>page 53</i>	Table C1	Floor classification for defined movement. <i>page 99</i>
Table 9.3	Influence of slab depth h and modulus of subgrade reaction k on the radius of relative stiffness l for $f_{cu} = 40 \text{ N/mm}^2$. <i>page 54</i>	Table C2	Applied limit values for MHE dimensions $T = 1.3 \text{ m}$ and $L = 1.8 \text{ m}$. <i>page 99</i>
Table 9.4	Design capacity of single dowels in shear, bearing and bending. <i>page 61</i>	Table C3	Worked example: applied limit values for MHE dimensions $T = 1.3 \text{ m}$ and $L = 1.8 \text{ m}$. <i>page 99</i>
		Table C4	Comparison between surface regularity measurements TR 34 limits and F-numbers. <i>page 100</i>

MEMBERS OF THE PROJECT COMMITTEES

PROJECT STEERING GROUP

Peter Goring	John Doyle Construction Ltd (<i>Chairman</i>)
Simon Austin	Loughborough University
Stuart Dorey	Precision Concrete Floors
Rob Gaimster	RMC Group plc
David Harvey	Stuarts Industrial Flooring Ltd
Tony Hulett	The Concrete Society (<i>Secretary and Project Manager</i>)
Pat Kinehan	ABS Brymar Floors Ltd
Kevin Louch	Stanford Industrial Concrete Flooring Ltd
John Mason	Alan Baxter & Associates (<i>representing the Department of Trade and Industry</i>)
Phil Shaw	Burks Green

DESIGN SUB-GROUP

Simon Austin	Loughborough University (<i>Convenor</i>)
Derrick Beckett	University College London
Jon Bishop	formerly Loughborough University
David Clark	Bekaert Building Products
John Clarke	The Concrete Society
Xavier Destrée	TrefilARBED Bissen SA
Robert Lindsay	Arup
Martin Rogers	George Hutchinson Associates Ltd
Phil Shaw	Burks Green
Paul Sprigg	Sprigg Little Partnership
Hendrick Thoof	N.V. Bekaert S.A.
Henry Tomsett	Arup

CONSTRUCTION SUB-GROUP

Stuart Dorey	Precision Concrete Floors (<i>Convenor</i>)
George Barnbrook	Concrete Advisory Service
Paul Choularton	Mitchell McFarlane & Partners Ltd
Andrew Keen	Somero Enterprises Ltd
Kevin Louch	Stanford Industrial Concrete Flooring Ltd
Chris Packer	HBG Construction Ltd
Martin Rogers	CFS (Combined Flooring Services) Ltd
Kevin Sutherland	Tarmac Topmix Ltd

MATERIALS SUB-GROUP

Rob Gaimster	RMC Group plc (<i>Convenor</i>)
John Dransfield	Cement Admixtures Association
Neil Henderson	Mott MacDonald
Darren Murgatroyd	ABS Brymar Floors Ltd
Bill Price	British Cement Association
Dave Smith	BRC Special Products
Shaun Speers	SIKA Armorex

USER NEEDS SUB-GROUP

Phil Shaw	Burks Green (<i>Convenor</i>)
John Bolus	British Industrial Truck Association
Iain Christie	Roy Hatfield Ltd
Kevin Dare	Face Consultants Ltd
Ken Hall	Prologis Developments Ltd
David Harvey	Stuarts Industrial Flooring Ltd
John Hodgins	Tibbett & Britten
Ray Lawless	Jungheinrich (GB) Ltd
Alan Worrell	SSI Schaefer Ltd

ACKNOWLEDGEMENTS

The authors of this report are employed by The Concrete Society. The work reported herein was carried under a Contract jointly funded by The Concrete Society, members of the Association of Concrete Industrial Flooring Contractors and the Secretary of State for Trade and Industry placed in July 2000. Any views expressed are not necessarily those of the Secretary of State for Trade and Industry.

The project to revise Technical Report 34 was undertaken as a Concrete Society project under the guidance of a Steering Group with members drawn from the various specialist organisations involved in procuring, designing and constructing concrete floors. The Chairman was Peter Goring, Technical Director of John Doyle Construction Ltd. The project was managed by Tony Hulett, Principal Engineer, The Concrete Society, who was also responsible for the overall drafting and collation of material for the report. Derrick Beckett, Visiting Professor at the Department of Civil and Environmental Engineering, University College London, and Dr John Clarke, Principal Engineer, The Concrete Society, undertook the preparation of the sections on design, and the worked examples. The technical editor was Nick Clarke, Publications Manager of The Concrete Society.

The review of surface regularity requirements for floors was an important aspect of the project. The Society is grateful to ACIFC

members Kevin Dare of Face Consultants Ltd who provided considerable resources for surveying and analysis and to Kevin Louch of Stanford Industrial Concrete Floors Ltd and Darryl Eddy of Twintec Industrial Flooring Ltd for making available floors for this research.

Extensive consultation and review of the project and drafts of this report were arranged throughout the two and a half years of the project. This included a series of briefings and discussions with engineers and contractors, and with the engineers of the Concrete Advisory Service. The Concrete Society is grateful to all those who provided feedback and comments on the drafts, listed below.

The Concrete Society is grateful to the following for providing photographs for use in the report:

Bekaert, Concrete Grinding Ltd, Face Consultants Ltd, Gazeley, Jungheinrich, Lansing Linde Ltd, Permaban, Precision Concrete Floors, SSI Schaefer, Stanford Industrial Concrete Flooring Ltd, Stuarts Industrial Flooring Ltd, Synthetic Industries, Twintec Industrial Flooring.

The photographs have been selected to illustrate particular aspects of floor construction and use, and some working practices shown may not necessarily meet with current site practice.

Etienne Alexander	Rinol Group	Paul Kelly	Somero Enterprises Ltd
Mike Amodeo	Mike Amodeo (Contractors) Ltd	John Lay	RMC Group plc
Rodney Arnold	Permaban Ltd	Dave Leverton	Kier Western
Malcolm Bailey	Radlett Consultants	Alan McDonack	ROM Ltd
Prof Andrew Beeby	University of Leeds	Darren Murgattroyd	ABS Brymar Floors Ltd
Jimmy Bittles	International Association of Cold Storage Contractors	Dirk Nemegeer	N.V. Bekaert S.A.
Bernard Bouhon	Silidur (UK) Ltd	Steve Parry	Silidur (UK) Ltd
John Brown	Synthetic Industries Europe Ltd	Bruce Perry	Grace Construction Products Ltd
James Buckingham	Silidur (UK) Ltd	Yves Pestel de Bord	ACIFC France
Andrew Callens	Bekaert Building Products	Darren Pinder	Concrete Grinding Ltd
Gregor Cameron	A J Clark Concrete Flooring Consultant	David Postins	ProLogis
Ralph Chaplin	Appleby Group Ltd	Steve Probut	Lansing Linde Ltd
Mike Connell	Fibercon UK Ltd	Derek Read	Compriband Ltd
Kevin Corby	White Young Green	Peter Remory	N.V. Bekaert S.A.
David Cudworth	The Concrete Society	Lee Pettit	Gazeley
Richard Day	Twintec Industrial Flooring Ltd	David Roberts	Fosroc
Alan Dobbins	Twintec Industrial Flooring Ltd	Arthur Rous	Floor Surveys Ltd
Darryl Eddy	Synthetic Industries Europe Ltd	Dr Massud Sadegzadeh	University of Aston
Simon Evans	Loughborough University	Neil Sanders	Don Construction Products Ltd
Paul Fleming	Nottingham Trent University	Steve Simmons	Sinbad Plant
Matthew Frost	Floor Surveys Ltd	Deryk Simpson	Concrete Advisory Service
Paul Frost	Sika Armorex	Chris Sketchley	Scott Wilson
Michael Gale	Consultant, USA	Pat Snowden	Snowden Flooring Ltd
George Garber	Reinforced Concrete Council	Dr Roger Sym	Consultant Statistician
Charles Goodchild	Beers Consultants	John Steel	AMEC
Ken Greenhead	Quarry Products Association	Peter Thompson	Slough Estates
Prof. Tom Harrison	RMC Group plc	Richard Tilden Smith	ACIFC
Tony Hartley	Stuarts Industrial Flooring Ltd	Vassoulla Vassou	University of Aston
Chris Henderson	Fosseway Flooring Systems	Andrew Waring	Andrew Waring Associates
Jan Hennig	Rapra Technology Ltd	Jean Marc Weider	Rocland France
Chris Hughes	Don Construction Products Ltd	Jon Williamson	Twintec Industrial Flooring Ltd
James Igoe	Birse	Neil Williamson	Monofloor Technology
Alistair Keith		Paul Withers	Joyes Pyke & Associates (now HPBW (Consultants) Ltd)

PREFACE

This is the third edition of Concrete Society Technical Report 34. The previous editions were published in 1988 and 1994. These became identified as the leading publications on many of the key aspects of concrete industrial ground floors, initially in the UK, and then in other parts of the world, especially Europe. The Concrete Society's experience in this field has steadily grown, through the expertise of its members who specialise in industrial floors, and through the experience of the engineers of the Concrete Advisory Service, who regularly deal with questions and problems relating to floors.

Guidance on the design and construction of ground-supported concrete floors was developed and published by the Cement and Concrete Association in the 1970s and 1980s. Concrete Society Technical Report 34 was published in 1988 and took account of the rapid development of new construction techniques, and gave guidance on thickness design. The second (1994) edition of TR 34 ⁽¹⁾ updated the guidance, but both these editions depended on and referred to the earlier publications for the design methodology.

A supplement to TR 34 was published in 1997 ⁽²⁾ dealing with flatness in free-movement areas, which is superseded by this present publication. The Society has also published guidance on particular aspects of concrete floors, in the form of separate publications ⁽³⁾, and articles, Current Practice Sheets and supplements to *Concrete* magazine.

This edition of Technical Report 34 differs from previous editions in two key aspects. Firstly, guidance on thickness design of slabs is complete, with minimal need for reference to other documents. Secondly, wherever possible, the guidance is non-prescriptive, allowing designers and contractors to use their skills to develop economic solutions for providing the required performance.

This edition is the result of a thorough review of all aspects of floor design and construction, including developments in Europe and the USA. The thickness design guidance is now primarily based on a limit state format. Surface regularity requirements have been reviewed in detail as a result of new survey work. The terminology for joints has been revised to make their function clear. Guidance on the specification of concrete now reflects current thinking on the role of cement, in that water/cement ratio is of greater significance than cement content.

It is anticipated that TR 34 will assist the development of international standards.

The Society acknowledges with thanks the support and assistance of its members and of the concrete flooring industry who have contributed to the preparation of this report, and also the help and comments provided by many other individuals and companies, both in the UK and overseas.

GLOSSARY OF TERMS AND ABBREVIATIONS

Key terms and abbreviations are defined below. A list of the symbols used in the report may be found at the start of Chapter 9.

Abrasion – Wearing away of the concrete surface by rubbing, rolling, sliding, cutting or impact forces. (Sections 5.2 and 10.5)

Aggregate interlock – Mechanism that transfers load across a crack in concrete by means of interlocking, irregular aggregate and cement paste surfaces on each side of the crack. (Section 8.8.2)

APR – adjustable pallet racking. (Section 3.1.4)

Armoured joint – Steel protection to joint arrises. (Section 8.9)

Block stacking – Unit loads, typically pallet loads, paper reels or similar goods, stacked directly on a floor, usually one on top of another. (Section 3.1.2)

Bump cutting – The process of using a straight edge to remove high spots when levelling the surface of a floor during construction. (Section 2.2.1)

California bearing ratio (CBR) – A measure of the load-bearing capacity of the sub-base or subgrade. (Section 6.3)

Crazing – Pattern of fine, shallow random cracks on the surface of concrete. (Section 5.6)

Curling – Local uplifting at the edges of the slab due to differential drying shrinkage between the top and bottom surfaces. (Sections 4.6 and 5.7)

Datum – A reference point taken for surveying. (Chapter 4)

Defined-movement area – Very narrow aisles in warehouses where materials handling equipment can move only in defined paths. (Sections 4.2 and 4.4)

Delamination – Debonding of thin layer of surface concrete. (Sections 5.8 and 11.3.6)

Dominant joint – A joint that opens wider than adjacent (dormant) joints in a floor with sawn joints. (Section 8.10.2)

Dormant joint – Sawn joint that does not move, usually because of failure of crack to form below the saw cut; generally associated with a dominant joint. (Section 8.10.2)

Dowel – Round steel bar or proprietary device used to transfer shear loads from one slab to the next across a joint and to prevent differential vertical movement, while permitting differential horizontal movement. (Section 8.8)

Dry shake finish – A mixture of cement and fine hard aggregate, and sometimes admixtures and pigment, applied dry as a thin layer and trowelled into the fresh concrete, to

improve abrasion resistance, suppress fibres and sometimes to colour the surface. (Section 11.4)

Ductility – The ability of a slab to carry load after cracking. (Sections 7.3 and 7.4)

Elevational difference – The difference in height between two points. (Section 4.1)

Flatness – Surface regularity over short distances, typically 300 mm. (Section 4.1)

Formed joints – Joint formed by formwork. (Chapter 8)

Free-movement areas – Floor areas where materials handling equipment can move freely in any direction. (Chapter 4)

Free-movement joint – Joint designed to provide a minimum of restraint to horizontal movements caused by drying shrinkage and temperature changes in a slab, while restricting relative vertical movement. (Section 8.3)

Isolation detail – Detail designed to avoid any restraint to a slab by fixed elements such as columns, walls, bases or pits, at the edge of or within the slab. (Section 8.6)

Joints – Vertical discontinuity provided in a floor slab to allow for construction and/or relief of strains. The terminology relating to the various types of joint is complex, and reference may be made to the definitions of individual joint types. (Chapter 8)

Jointless floors – Floors constructed in large panels typically 50 m square without intermediate joints. (Section 2.2)

Large area construction – Area of floor of several thousand square metres laid in continuous operation. (Section 2.2)

Levelness – Surface regularity over a longer distance, typically 3 m, and to datum. (Section 4.1)

Line loads – Loads acting uniformly over extended length. (Sections 3.1.3 and 9.9.5)

Load-transfer capacity – The load-carrying capacity of joints in shear. (Section 8.8)

Long strip construction – Area of floor laid in strips. (Section 2.2)

Mezzanine – Raised area, e.g. for offices, above an industrial floor but supported by it; typically a steel frame on baseplates. (Section 3.1.4)

MHE – Materials handling equipment. (Section 3.2)

Modulus of subgrade reaction – Measure of the stiffness of the subgrade; load per unit area causing unit deflection. (Section 6.2)

Movement accommodation factor (MAF) – The movement a joint sealant can accept in service expressed as a percentage of its original width. (Section 8.12)

Panel – Smallest unit of a floor slab bounded by joints. (Chapter 8)

Pile-supported slab – Floor constructed on, and supported by, piles; used where ground-bearing conditions are inadequate for a ground-supported floor. (Section 2.4, Appendix D)

Point load – Concentrated load from baseplate or wheel. (Section 3.1.4)

Power finishing – Use of machinery for floating and trowelling floors. (Chapter 10)

‘Property’ – term used for defining floor regularity: elevational differences or measurements derived from elevational differences that are limited for each class of floor (Section 4.1):

Property I – The elevational difference in mm between two points 300 mm apart.

Property II – To control flatness, the change in elevational difference between two consecutive measurements of elevational difference (Property I) each measured over 300 mm.

Property III – The elevational difference between the centres of the front load wheels of materials handling equipment in mm.

Property IV – To control levelness, the elevational difference between fixed points 3 m apart.

Racking – Systems of frames and beams for storage, usually of pallets. (Section 3.1.4)

Racking end frames – Pairs of vertical steel section members connected by frame bracing, which support racking shelves carrying stored goods. (Section 3.1.4)

Remedial grinding – The process of removing areas of a floor surface by abrasive grinding of the hardened concrete usually in order to achieve the required surface regularity. (Chapter 4)

Restrained-movement joint – Joint designed to allow limited movement to relieve shrinkage-induced stresses in a slab at pre-determined positions. (Section 8.4)

Sawn joint – Joint in slab where a crack is induced beneath a saw cut. (Chapter 8)

SFRC – Steel-fibre-reinforced concrete. (Section 9.6.2)

Slab – Structural concrete element finished to provide the wearing surface of a floor; can also be overlaid by screeds or other layers.

Slip membrane – Plastic sheet laid on the sub-base before concrete is placed, to reduce the friction between slab and sub-base. (Section 6.5) Note: other forms of membrane are used for other requirements, e.g. gas membranes.

Slip resistance – The ability of a floor surface to resist slippage. (Section 5.9)

Sub-base – Layer (or layers) of materials on top of the subgrade to form a working platform on which the slab is constructed. (Section 6.4)

Subgrade – The upper strata of the existing soil under a ground floor. (Section 6.3)

Surface regularity – Generic term to describe the departure of a floor profile from a theoretical perfect plane. (Chapter 4)

Tang – Shear stud or fitting on armoured joint to provide bond to adjacent concrete. (Section 8.9)

Tied joint – Joint in a slab provided to facilitate a break in construction at a point other than a free-movement joint; sufficient reinforcement runs through the joint to prevent movement. (Section 8.5)

Toughness – Alternative term to ductility (which is the preferred term), used with reference to steel-fibre-reinforced concrete. (Section 8.4)

Uniformly distributed load – Load acting uniformly over relatively large area. (Section 3.1.2)

VNA – Very narrow aisle. (Section 3.1.4)

Wearing surface – The top surface of a concrete slab or applied coating on which the traffic runs. (Section 2.2)

AMENDMENTS

Page no.	Column	Location	Amendment
xiii	1	Defined-movement area, after '4.4'	Insert 'and Appendix C'
10	2	Paragraph 2, line 5, after 'each'	Insert 'large'
10	2	Paragraph 2, line 6	Delete '4-5', substitute '10-15'
20	1	Table 4.1 Row 4 'Datum'	Insert 'Section 4.8 in column 2',
22	2	Line 9	Delete sentence: 'The lines should be distributed uniformly across the floor with the total length of lines in each direction proportional to the dimensions of the floor.' substitute: 'The lines should be distributed uniformly across the floor or sections of large or irregular floors with the total length of lines in each direction being equal.'
23	1	Bullet 3	Delete bullet; substitute 'any point on the Property IV survey grid is outside ± 15 mm of datum where a datum plane is available, or where a datum plane is not available outside ± 15 mm of the mean floor level as calculated from the Property IV survey.'
24	1	Table 4.3	Delete note 'For all classifications, all points surveyed should be within 15 mm from datum'
24	2	Bullet	Delete bullet
26		New section	8.8 LEVEL TO DATUM The surface level of all industrial floors (of all flatness classifications) should be within ± 15 mm of the intended structural floor datum level, as shown on the contract drawings. The levels should be assessed on a 3m grid by levelling with reference to the site datum. This grid can be the same grid as used for the Property IV surface regularity check undertaken for free movement assessment. When the site reference datum plane used during construction or the original intended structural floor datum level are not known at the time of the surface regularity survey, it is not possible to undertake the level to datum check. The assessment of Properties I, II, & III relates to differences in level not absolute levels, and the surveys used for the assessment of these properties will not check the level to datum.

38	1	Paragraph 4, line 5, after 'joint.'	Insert 'See also p47, <i>Dominant and dormant joints</i> '.
47	1	Final paragraph, line 6, after 'joints.'	Insert 'See Section 7.3'.
50	2	Last list entry	Delete 'percentage', substitute 'ratio'
51	2	Paragraph 3, "In some circumstances..."	Delete complete paragraph.
52	2	Line 8, below Equation 9.2	Delete $k_1 = 1 + (200/d)^{0.5}$ Substitute $k_1 \leq 1 + (200/d)^{0.5}$
54	2	9.6.3 After subtitle <i>Ultimate limit state (ULS)</i>	Insert "These factors apply to point loads only. For UDLs and line loads see Section 9.9.5."
58	1	Paragraph 2, line 4	Delete ' $a/l < 2$ ', substitute ' $a/l < 0.2$ '
58	1	Paragraph 2, line 4	Delete 'However'
58	1 and 2	In Equations 9.10b, 9.11b, 9.12b, 9.13b and 9.14b	Delete ' $a/l > 0.2$ ', substitute ' $a/l \geq 0.2$ '
59	1	Above subtitle <i>Line loads</i>	Insert "Where a load is dynamic, a global safety factor of 2.0 should be used."
59	2	Paragraph 2, line 5	Delete "As indicated in Section 9.3.2 ... load widths as described below."
61	1	Line 9	Delete 'non-circular sections', substitute 'square dowel'.
62	2	9.11.1 Paragraph 3, line 4	Delete "this should not be relied upon", substitute "quantification requires careful appraisal".
63	1	Line 21	Delete 'percentage', substitute 'ratio'
63	1	<i>Steel fibre reinforcement</i> above 'The Draft Eurocode...'	Insert "The RILEM guidance depends on the presence of conventional reinforcement. However, tests on large scale fibre-only reinforced ground supported slabs have shown that application of the above guidance gives conservative results"
65	1	Paragraph 3, line 8	Delete 'mm'.
65	2	Subtitle <i>Recommendations for dealing with restraint stresses</i>	Delete subtitle, substitute <i>Dealing with restraint stresses</i>
66	1 and 2	Paragraph "Hence, in the absence ... to block stacking"	Delete paragraph, substitute "The foregoing information, on the calculation of theoretical stresses, might be used by designers who wish to explore the subject further. However, there is little experience of the quantification of these stresses and the application of results in design. Furthermore, the interaction between shrinkage-induced stresses and those due to loading are not well understood. All practical efforts should be taken to reduce the stresses caused by restraint, including attention to the relationship between the time of loading a floor and the amount of drying shrinkage to be expected thereafter. Floors are also at risk if they are loaded before the concrete strength is fully developed."
88	1	Reference 62, line 3	Delete '225', substitute '226'.
93	1	Equation 9.4	Delete equation, substitute $l = [E_{cm} h^3 / 12 (1 - \nu^2) k]^{0.25}$
94	1	Line 7	Delete '5.49', substitute '5.58

94	1	Line 16	Delete ' $= 0.56 + 0.17 = 0.73 \text{ N/mm}^2$ ', substitute ' $= 0.56 + 0.252 = 0.812 \text{ N/mm}^2$ '
94	1	Line 18	Delete ' $0.73 \times 1375 \times 131.25 = 131.7 \text{ kN}$ ', substitute ' $0.812 \times 1375 \times 131.25 = 146.5 \text{ kN}$ '
94	1	Line 19-23	Delete paragraph, substitute 'This is slightly greater than the required 144 kN and hence the design is adequate'.
94	1	Section B4, paragraph 2	Delete paragraph "Note there ... restraint stresses."
99	2	Second paragraph, line 1	Delete 'Fmin', substitute ' F_{\min} '
102	1	D4.3 Punching shear	Delete "Punching of the slab... Section 9.11.", substitute "In the absence of any data on piled supported slabs, checks should be carried out in accordance with the approaches in BS 8110 or draft Eurocode 2. See also Section D2."
103	2	Equation at bottom line.	Delete $(0.18/\gamma_c) k (100\rho f_{ck})^{0.33}$ Substitute $(0.18/\gamma_c) k_l (100\rho_l f_{ck})^{0.33}$

1 INTRODUCTION

1.1 SCOPE

All forms of activity in buildings need a sound platform on which to operate – from manufacturing, storage and distribution, through to retail and leisure facilities – and concrete floors almost invariably form the base on which such activities are carried out. Although in many parts of the world conventional manufacturing activity has declined in recent years, there has been a steady growth in distribution, warehousing and retail operations, to serve the needs of industry and society. The scale of such facilities, and the speed with which they are constructed, has also increased, with higher and heavier racking and storage equipment being used. These all make greater demands on the concrete floor.

A warehouse or industrial facility should be considered as a single interconnected system, and maximum efficiency and economy will be achieved only if all elements – the floor, the storage systems and the materials handling equipment – are designed to common tolerances and requirements by the various parties – owner/user, designers, contractors and suppliers. This report provides up-to-date guidance on the successful design and construction of industrial floors to meet these demands.

The guidance on design of slab thickness and joint detailing relates to internal concrete floors that are fully supported by the ground and are primarily in industrial, warehousing and retail applications. Most aspects of the report are relevant to small workshops, commercial garages, sports and other recreational facilities. Guidance is given on designing for nominal loads for such situations, but the thickness design approach is intended for heavily loaded floors.

Design methods for pile-supported floors are outlined in Appendix D but for detailed design of such floors, reference is made to structural codes of practice. The guidance on construction, material performance and other requirements is valid for all ground floors.

The report is not intended for use in the design or construction of external paving or for conventional suspended floors in buildings.

In most industrial, warehousing and retail buildings, concrete floors will provide a durable wearing surface, provided that the guidance on design, materials and construction procedures is followed. In some environments the floor must be protected by other materials to give chemical resistance. Such protective systems are outside the scope of this report and specialists should be consulted for guidance on their selection and application.

Concrete floors are used extensively in cold stores and the report provides some guidance on these.

Costs of construction are not discussed: current information can be obtained from specialist contractors and suppliers of plant and materials.

Figures 1.1 to 1.5 show some typical situations in which concrete floors provide strong and long-lasting performance to meet the needs of owners and users.



Figure 1.1: Low-level operation in which pallets are handled by a counter-balance truck.



Figure 1.2: A reach truck with a telescopic mast between wide aisle racking.

1.2 STRUCTURE OF THE REPORT

Most buildings used for manufacturing, storage and distribution have concrete floors. Similar floors are also found in commercial premises and sports and other recreational facilities. Successfully constructed floors are the result of an integrated and detailed planning process that focuses on the needs of the floor owner/user to deliver a completed project at an acceptable and predictable cost, that is, to give value for money.

It should be emphasised that the term 'value for money' does not mean simply the lowest price. An assessment of value can only be made by a customer and requires the overall performance of the floor throughout its design life to be balanced against the construction cost, taking into account the planned usage and the maintenance regime.

To give value to floor owners and users, all parties to the design and construction should be engaged in the procedure from the time the floor is at concept stage right through to handover. This report provides a framework for the process of designing and constructing a floor that will fully satisfy the needs of the owner or user.

The use of a design brief from the start of the planning process is strongly recommended. This will focus attention on all the detailed operational requirements for the floor throughout the process, alongside consideration of the site and environmental issues. All aspects of design must be considered: it is wrong, for example, to deal with the thickness design, while leaving other aspects, such as joint design and layout and surface regularity requirements, to a later stage.

Construction equipment and methods are not described in detail in the report as the continual development and innovation of techniques will make any advice likely to become out of date. Various aspects of current approaches may be seen in the photographs throughout the report but specialist contractors and suppliers should be consulted for the latest information.

The report is in 13 chapters, divided into four parts, with six appendices that supplement the guidance in the main report:

Part One: Operating requirements

The principal requirements of a floor are related to the techniques used in its construction; the common construction approaches are summarised here. This part provides the means for interpreting the user's needs in terms of loads, surface regularity and surface characteristics and developing these into a design brief. (A model design brief is included in Appendix A to help with this process.)

Part Two: Design aspects

This part provides design guidance. The design inputs are the design brief, site geotechnical data and information on construction techniques and materials. The design output is a specification for the floor construction, including slab thickness, joint construction and layout details, and for the materials. Where appropriate, performance standards are used.



Figure 1.3: A transfer aisle in a large distribution warehouse. Goods are stored in high racking (right) and deposited at the ends of the aisles. Counterbalance trucks then assemble the goods in the collation area for onward distribution.

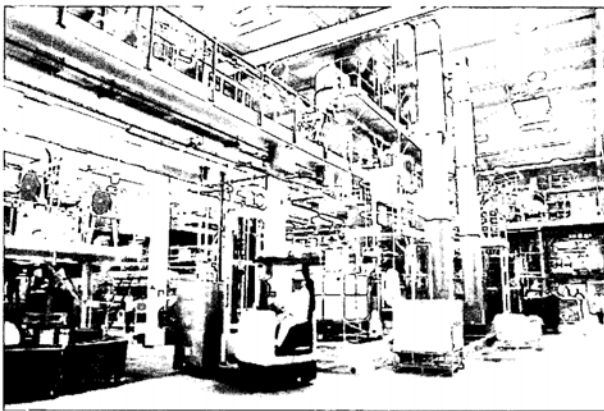

Figure 1.4: The concrete floor in this factory provides a durable platform designed to withstand wear and tear from the materials handling equipment and the products.



Figure 1.5: The floor in this DIY retail store provides an attractive surface. A dry shake finish has been used.

Part Three: Concrete performance and component materials

Basic guidance is given on specifying, producing and placing concrete for floors.

Part Four: Best practice in construction and maintenance

This part highlights key areas of construction activity that affect quality and performance, but does not aim to be comprehensive or prescriptive. Advice is also given on maintenance of concrete floors.

Appendices

Appendix A: Model design brief for concrete industrial ground floors

The model design brief is intended to help owners and users to formulate their requirements and to provide a basis for discussion with the engineers, contractors and suppliers who are to undertake the floor construction project.

Appendix B: Worked example: thickness design of a ground-supported floor slab

This worked example illustrates the floor thickness design for a typical large warehouse, including load combinations, punching shear and serviceability.

Appendix C: Floor regularity

Recent developments in floor surveying are explained, and an alternative method of surveying the surface regularity of defined-movement areas is proposed. Specifications outside the UK are also discussed.

Appendix D: Pile-supported slabs

This appendix outlines the analysis and design of pile-supported floor slabs, and highlights key points on joints.

Appendix E: Design with steel fabric reinforcement

This appendix provides guidance on the structural aspects of steel fabric in slabs in the light of research and tests, and extends the worked design example in Appendix B.

Appendix F: Sources of information

Useful sources of information and contact details are listed here.

Sponsor profiles

Profiles of the sponsors of the project who supported the revision and publication of this edition of TR 34 are included before the subject index.

1.3 PROCUREMENT METHODS

Used as a whole, this report provides the information necessary for assessing the requirements for a concrete industrial ground floor, for designing the floor and for developing a specification for construction. It does not describe the construction process in detail although much of the construction process is implicit in the descriptions of the floor's elements.

It can be used for any procurement method as it is concerned with the process of design and construction. It does not deal with the contractual issues relating to the implementation of the process.

For example, a design-and-build contractor could manage the complete process on behalf of a client from needs assessment through to construction or could carry out the design-and-build elements for a consulting engineer acting on behalf of a client. Alternatively, a contractor could be building to a design provided by others on a conventional sub-contract basis. Whatever the procurement route, the participants can use this report.

1.4 INNOVATIONS IN FLOOR TECHNOLOGY

The second edition of Technical Report 34⁽¹⁾, published in 1994, commented on topics that would benefit from research and highlighted the lack of information on the performance of joints and other factors. The review for this edition has drawn on recent (and previously reported) research, and specific areas of new work have been commissioned. These are summarised here together with other topics that have yet to be addressed.

Classification of floor loads

A system for the classification of floor loadings has been in common use for some years and is based on BRE Information paper IP19/87⁽⁴⁾. As a result of the review for this edition of TR 34, it is suggested that the classification system does not fully reflect current practice as building heights and associated loadings have increased. Further review in this area is needed. It is recognised that any changes to the system would require full consultation with the industry, in particular with commercial estate agents, who widely depend on load classifications. (Section 3.3)

Floors in very narrow aisles

Methods for surveying surface regularity in very narrow aisles used in the USA and elsewhere in Europe were reviewed: it was concluded that the UK industry should consider in the longer term a move towards the measurement of the effect of the rear wheels of trucks used in very narrow aisles. At present, only the front axle is considered. This would bring the UK into line with common practice elsewhere and also anticipates the development of a CEN standard and possibly an ISO standard.

Appendix C sets out an alternative method of surveying defined-movement areas that is derived from a similar US method.

Steel fabric in long strip construction

A traditional approach to detailing steel fabric in long strip construction⁽⁵⁾ has been to relate the area of steel to the distance between restrained-movement joints, often leading to the use of B-type fabrics. In the preparation of this report, it was concluded that this approach increases the possibility

of mid-panel cracking; it is therefore recommended that restrained-movement joints are provided at intervals of about 6 m, and that the area of steel is kept in the range of approximately 0.1 to 0.125%. The effect of this will be that steel areas will be the same in both directions and that A-type fabrics will be appropriate in most circumstances. (Sections 7.3 and 8.10)

Structural application of steel fabric

Traditionally, the small proportions of steel fabric used in floors have not been considered in calculations of load-carrying capacity. The design methods in Chapter 9 are based on plastic analysis, which depends on the ductility of the slab section. Research at Greenwich and Leeds Universities and testing at Cranfield University (Shrivenham) have confirmed the ductility and therefore the load-carrying capacity of designs with steel fabric. A full report on the project is in the course of preparation ⁽⁶⁾. Appendix E provides design guidance specific to steel fabric and should be read in conjunction with Chapter 9 and Appendix B.

Ductility requirements

As part of the research project into the use of steel fabric, the ductility requirements of ground-supported slabs were investigated. Beeby has developed an analysis of the rotational capacity requirements for the development of the yield lines beneath point loads ⁽⁶⁾. The analysis suggests that the commonly used measure of ductility ($R_{c,3}$) should be reappraised (Section 7.4).

Fibre-reinforced concrete technology

Synthetic fibres are being developed that have the potential to provide concrete with significant ductility. These fibres are not yet in common use in floors but are an interesting development in fibre reinforcement technology. Further development could take into account a reappraisal of ductility requirements, as suggested by the research at Leeds (see *Ductility requirements* above). This research also suggests that existing steel fibre performance requirements might be reviewed, with the possibility that shorter fibres may provide adequate ductility.

Further development may therefore depend on an alternative testing technique to the commonly used beam tests and associated $R_{c,3}$ values. Plate tests of various types are in limited use, but further work is required to provide calibrated performance data from such tests that can be used in proven design guidance.

Pile-supported slabs

The use of pile-supported slabs has increased significantly as developments take place on poorer ground. Although the structural design of pile-supported slabs is outside the scope of this report, most other aspects of these slabs are within the scope. Their design is discussed further in Appendix D.

Load-transfer capacity at joints

The load-carrying capacities of a slab at a free edge and at a free corner are approximately 50% and 25% of the capacity at the centre of the slab. The ability to share loads across edges

is therefore of great importance. Hitherto, design guidance has been based on somewhat vague and unquantified assumptions on aggregate interlock and other factors. The review for this edition has concluded that aggregate interlock can be relied upon for predominately static loads, providing joint opening is limited. However, where dynamic loads are more dominant, a more cautious approach should be taken. Designers are encouraged to assess the capacity of all load-transfer mechanisms, and design methods are provided in Chapter 9 for calculating the load-transfer capacity of standard dowels and steel fabric.

Research is underway at Loughborough and Leeds Universities to improve understanding of the degradation processes involved with aggregate interlock when loaded under dynamic conditions. Research at the University of Queensland ⁽⁷⁾ has evaluated the load-transfer capacity of a range of mechanisms and examined the effect on burst-out capacity of the use of steel fibres.

Thermal and moisture movements

Work at Loughborough University ⁽⁸⁾ has examined slab movements, and slabs in use have been extensively monitored. Key findings are that thermal movements during the first 48 hours are more significant than previously thought. This has emphasised the desirability of avoiding high cement contents in concrete and of adopting measures to reduce the heat of hydration. It has drawn attention to the interaction of thermal and shrinkage movements, which are affected by the seasonal timing of construction. The project also reviewed published work on slip membranes, where there is some evidence that their omission is unlikely to reduce curling significantly. See also next paragraph.

Control of cracks induced by shrinkage

Work at Loughborough University ⁽⁸⁾ has considered the role of reinforcement in controlling shrinkage-induced cracking in slabs and the effect of friction between slab and sub-base. The results support empirical observations that the nominal areas of steel fabric commonly used cannot directly prevent cracking as the tensile capacity of the concrete section exceeds the load capacity of the steel at these levels of reinforcement. The work has confirmed that the strategy of inducing preplanned cracks at about 6 m intervals is effective as they open and relieve stresses. The phenomenon of dominant joints is not fully understood but is considered to be affected by the timing of saw-cutting the joints. It is also considered to be a function of early and differential loading. The frictional restraint between the sub-base and slab was found to be much lower than previously thought but this has not been quantified. (Section 8.10 and 9.12.3)

Curling

Curling of floor slabs has been, and continues to be, a cause for concern. Curling is likely to occur in most floors but is not usually significant. However, its magnitude is unpredictable and strategies for reducing or eliminating it are not well developed, but it is recognised that reducing the drying shrinkage of the concrete is desirable. More research is

needed to assess the effects of joint openings and the potential for restraining uplift at joints by the use of reinforcement across the joints. (Sections 4.6 and 5.7)

Delamination

It has become apparent during this review that surface delamination is not fully understood. A research project at Kingston University into the subject has been proposed. (Section 5.8)

Abrasion resistance

The factors affecting abrasion resistance have been thoroughly reviewed in collaboration with Aston University ⁽⁹⁾. The principal conclusion is that cement content has only a limited bearing on abrasion resistance and that high cement contents do not contribute significantly to its enhancement. (Sections 5.2 and 10.5)

Remedial grinding

Where remedial grinding is used to achieve the specified surface regularity tolerances in defined-movement areas, statistical analysis of survey data obtained after grinding has shown that a high proportion of results are at (or just within) the 100% limit value. The operational significance of this has not been fully assessed. Research is required in this area. (Section 4.4)

1.5 IMPLICATIONS OF NEW DESIGN RECOMMENDATIONS

Comparison of the new guidance on thickness design of slabs in this report with the guidance that it replaces is complex because it is difficult to identify all possible scenarios. It has been unusually difficult as this edition of TR 34 is the first to give comprehensive guidance on slab design.

The two previous editions depended on other publications that were themselves open to interpretation; and the design approaches were based on elastic analyses by Westergaard and others. Designers moving from Westergaard's approach to the limit state analysis set out in this report will find that floors may be considerably thinner. However, designs for most projects of significant size in recent years have been based on the plastic design methods that were introduced in outline form in Appendix F of the 1994 edition of this report.

Design comparisons between this edition and Appendix F in the 1994 edition suggest that floors designed to be 150 to 200 mm thick will become about 15 mm thicker. However, many floors are now designed on the basis of loads only at the centre of slabs, on the assumption that sufficient load-transfer capacity is available at abutting edges of the slab. Where this is the case, floors may become marginally thinner. Design guidance is also now provided to enable more comprehensive assessment of load-transfer capacity, and it is anticipated that attention to this aspect of design will increase capacity at edges.

A further factor is that existing sub-base tolerances of +0 –25 mm have been retained in this edition to ensure that above-datum levels of sub-base do not occur, which could result in slabs being constructed that are thinner than intended. There has been no fundamental change in the guidance on this point, but in this edition greater emphasis has been placed on this aspect of construction control so as to minimise the risk of slabs being constructed to less than the design thickness.

Overall, it is anticipated that, by following the design guidance in this edition of TR 34 in place of the former guidance, design thickness of floor slabs will increase marginally.

PART ONE

OPERATING REQUIREMENTS

The performance of a floor depends on the techniques used in its construction. Some key requirements need specific measures to be taken during the design and construction process: the current approaches are summarised in this Part. This is aimed particularly at owners and users of industrial floors, and at the design and construction team.

Concrete floors are integral to the successful operation of industrial, distribution and warehouse facilities, but they are also widely used in smaller premises such as garages, workshops, sports and recreational facilities and commercial premises of all types.

The descriptions of operating requirements in the chapters in this Part are provided to help designers to carry out a full appraisal of the planned use of a floor and to develop a bespoke design brief. (A model design brief is given in Appendix A, which can be adapted to suit the requirements of each project, and to form the basis for detailed discussion between the parties.)

The principal operating requirements for concrete industrial ground floors are covered as follows:

- static loads from storage racking, mezzanines and other fixed equipment (Chapter 3) Section 3.1
- dynamic loads from materials handling equipment (Chapter 3) Section 3.2
- surface regularity (Chapter 4)
- surface characteristics (durability, appearance, slip resistance, etc) (Chapter 5).

CONTENTS	
2 OVERVIEW OF FLOOR CONSTRUCTION	
2.1 Introduction	4.5 Survey practice for all floor types
2.2 Floor construction methods	4.6 Change of floor flatness with time
2.3 Cold stores	4.7 Converting floors to defined-movement specifications
2.4 Pile-supported floors	
3 FLOOR LOADINGS	5 FLOOR SURFACE REQUIREMENTS
3.1 Static loads	5.1 Introduction
3.2 Materials handling equipment	5.2 Abrasion resistance
3.3 Classification of floor loadings	5.3 Chemical resistance
	5.4 Colour and appearance
	5.5 Cracking
4 SURFACE REGULARITY	5.6 Crazeing
4.1 Introduction: the importance of surface regularity	5.7 Curling
4.2 Floor types: free and defined movement	5.8 Delamination
4.3 Surface regularity in free-movement areas	5.9 Slip resistance
4.4 Surface regularity in defined-movement areas	5.10 Surface aggregate
	5.11 Surface fibres
	5.12 Surface finish marks

Previous page
is blank

2 FLOOR CONSTRUCTION METHODS AND SURFACE CHARACTERISTICS

2.1 INTRODUCTION

Successful floors are the result of an integrated and detailed planning process that addresses the needs of the user in a readily understandable way. To play their part in this process, owners and users should have a basic understanding of how floors are constructed, the advantages and limitations of the various techniques, and the implications for joint layout, surface regularity, and racking layout.

The majority of floors perform satisfactorily, however, it is important that owners and users have reasonable expectations of their floor surfaces. Floors are built in an on-site environment from naturally occurring materials, which are themselves variable. End results may vary more than, for example, a factory-produced product. Floors are not perfectly flat and uniform in colour and are unlikely to be totally free from cracks or surface crazing.

The main characteristics of concrete floor surfaces are described in Chapter 5, along with guidance on assessing their operational significance. Some of these features are by their nature difficult to describe in quantitative terms and the interpretation of any description can be subjective. However, it is hoped that an understanding can be developed of what can be achieved in floor surfaces in practice.

The user's requirements should be established by preparing a design brief, such as that in Appendix A, by:

- establishing specific requirements, having carefully considered each of the aspects described in Chapters 3, 4 and 5
- benchmarking against existing floors. Where possible references to these floors should be included in the contract details.

There is no single ideal solution for each situation; as in all design, compromises have to be reached based on needs and costs. Also, techniques and materials are being constantly developed to provide better performance and better value.

An ideal floor would be perfectly flat and level and have no joints. However, there are limits on the dimensional accuracy of any construction and, as concrete shrinks after construction, it is not possible to dispense with joints completely. Joints are also required because there are practical limitations on the area of floor that can be constructed at any one time.

At the design stage the designer should plan the joint layout, give indications of the expected performance throughout the life of the floor, and set out the expected number and performance of the joints. Attention should be given to the early life of the floor as contraction and shrinkage take place and over the long term. The performance factors to be considered

should include joint width, levelness across joints and the stability of joint edges and joint sealants. Some cracking of slabs between joints may be expected, particularly in larger slab panels and in 'jointless' construction, see Section 2.2.2. The significance of any such cracking in terms of operational requirements or appearance should be considered at this stage.

The floor user will also be concerned with the regularity of the floor surface. Detailed guidance on surface regularity of floors is given in Chapter 4 and Appendix C to help in the selection of the appropriate specifications for the floor.

As noted, construction methods are developing continually and at any time contractors are able to offer alternative solutions and outcomes. It is important to make well-informed decisions on what the owner or user is going to get and at what cost.

The descriptions of construction methods in the following section are not intended to be definitive but should be useful for owners and users when discussing a flooring project with a designer or contractor. Issues to consider carefully include:

- Joints – performance and maintenance: Chapters 8 and 13
- Surface regularity: Chapter 4 and Appendix C
- Colour, abrasion resistance and other floor surface requirements: Chapter 5.

2.2 FLOOR CONSTRUCTION METHODS

A ground-supported floor slab is made up of layers of materials and components, as illustrated in Figure 2.1. The construction method has a bearing on a number of aspects of the performance of the floor. The principal considerations relate to shrinkage, and flatness and levelness (surface regularity). The various construction methods also have different outcomes in terms of speed of construction, joint construction, joint frequency and cost. As noted earlier, cost aspects of floor construction are not discussed in this report.

2.2.1 Large area construction – jointed

Large floors up to several thousand square metres in area can be laid in a continuous operation (Figure 2.2). Fixed forms are used only at the edges of the construction at intervals of typically 50 m. Concrete is discharged into the floor area and spread either manually or by machine. Levels are controlled either manually using a target staff in conjunction with a laser level transmitter or by direct control of laser-guided spreading machines.

Over such large areas, it is not possible to control the surface regularity in relation to fixed formwork and so there are limitations on the accuracy that can be achieved unless specific

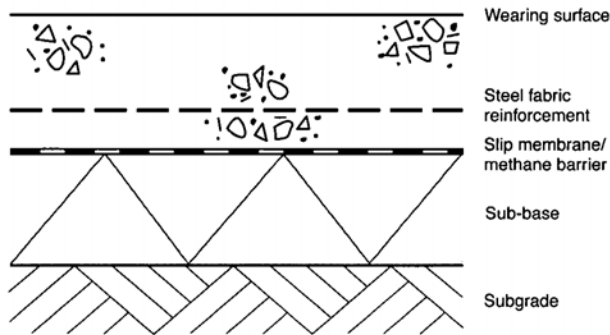

Figure 2.1: Typical slab construction.

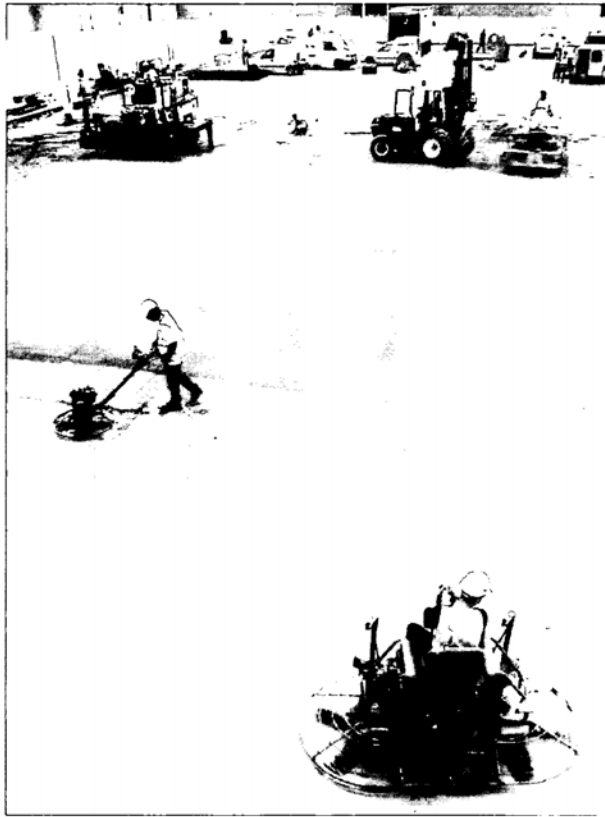

Figure 2.2: Large area construction. In the background (left) a laser screed machine is spreading and levelling the concrete. To the right a dry shake finish is being spread mechanically. In the foreground, the concrete placed several hours earlier is being finished by a power float and a ride-on power trowel.

measures are adopted. This form of construction is commonly used to construct free-movement areas, see Chapter 4. Section 4.7 gives guidance on conversion of such floors from free-movement to defined-movement floors, which have tighter tolerances on surface regularity.

With large area jointed construction, tighter surface regularity tolerances can be achieved by using additional measures. For example, pre-positioned screed rails can provide a guide for finishing operations. See also long strip construction in Section 2.2.3. On machine-laid floors, additional manual levelling techniques often referred to as ‘bump

cutting’ can be used on the stiffening concrete surface to remove ‘high spots’ and to also create tighter tolerances.

After the floor has been laid and finished, it is sub-divided into panels by sawn restrained-movement joints to relieve shrinkage-induced stresses, typically on a 6 m grid in both directions. Formed free-movement joints are used at the edges of each area. Typically, these free-movement joints open by 4–5 mm.

2.2.2 Large area construction – jointless

Jointless floors are built using large area construction methods. The word ‘jointless’ can be misleading, as there is a practical upper limit to the area of concrete that can be placed in a single continuous operation. No joints are sawn, but steel fibres incorporated into the concrete mix control the width and distribution of cracks caused by shrinkage. It is not usually possible to guarantee that there will be no visible cracks in the floor. Therefore, performance criteria with regard to the width and frequency of cracks should be established.

A benefit of jointless floors to the building user is the opportunity of having relatively large areas of floor with no joints. However, the formed free-movement joints at the edges of each area will be wider than in floors with multiple sawn joints and will typically open by 20 mm.

2.2.3 Long strip construction

The floor is laid in a series of strips typically 4 to 6 m wide, with forms along each side (Figure 2.3). Strips can be laid alternately, with infill strips placed later. They can also be laid consecutively or between ‘leave-in-place’ screed rails. With the latter method, large areas can be poured in a method similar to large area construction. Strips are laid in a continuous operation and joints are sawn transversely across each strip about 6 m apart to accommodate longitudinal shrinkage. Formed free-movement joints are provided at intervals similar to those in large area jointed construction, see Section 2.2.1.

As formwork can be set to tight tolerances, and as the distance between the forms is relatively small, this method lends itself to the construction of very flat floors, see Chapter 4.



Figure 2.3: Long strip construction, allowing access for levelling using a highway straightedge.

Floors built in strip construction will have more formed joints than those built by large area methods, but these joints are usually designed to be in non-critical positions such as under storage racking, see Sections 8.7 and 8.10.

2.2.4 Wide bay construction

Wide bay construction is a variation on large area construction but with bay widths limited to 12 to 15 m. Limiting the bay width permits access for the use of 'bump cutting' techniques on the concrete surface to control the surface tolerances more closely.

2.2.5 Two-layer construction

In two-layer construction, a hardened slab is overlain with a second layer that is placed between accurately levelled screed rails at relatively close spacings (typically about 4 m) on the lower slab. This method of construction is more complex than others but can be used for very flat floors. The principle is similar to that used for levelling screeds, as described in BS 8204-2⁽¹⁰⁾.

2.3 COLD STORES

Floors in cold stores are built by similar techniques to other industrial floors but they incorporate an insulation layer above a heater mat to protect the sub-base from frost. The layer structure is shown in Figure 2.4.

Specific references are made to cold stores elsewhere:

- Soils and sub-bases: Chapter 6
- Joints: Chapter 8
- Concrete maturity: Section 10.2.3
- Use of admixtures: Section 11.3.6

Information on cold store heater mats and other aspects of cold store construction can be found in *Guidelines for the specification, design and construction of cold store floors*⁽¹¹⁾.

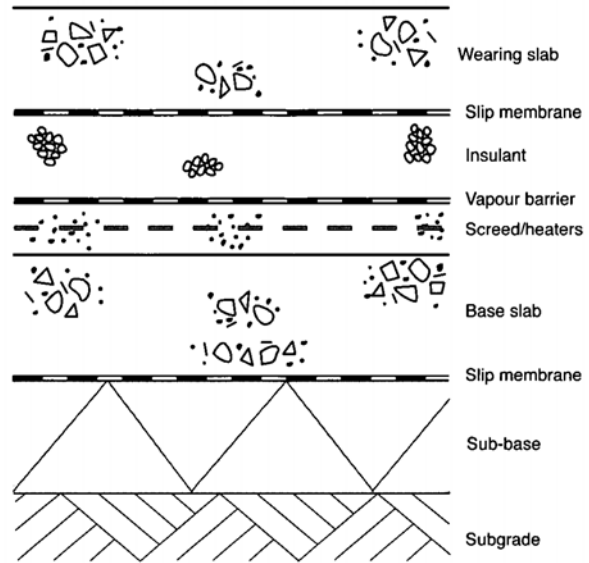

Figure 2.4: Typical construction layers in cold stores.

2.4 PILE-SUPPORTED FLOORS

If geotechnical investigations indicate that ground conditions are inadequate for a ground-supported floor, the floor may be constructed on piles. In principle, any of the construction methods discussed earlier can be used, but most such floors are built with a jointless method.

For narrow aisle warehouses, the design of the joint layout arrangement has to take into account both the piling grid and the racking grid. This may require particular attention where long strip construction of a pile-supported slab is planned, as the preferred positioning of the strip joints under the storage racking may not be compatible with the piling grid.

More information on pile-supported floors is given in Appendix D.

3 LOADINGS

3.1 STATIC LOADS

3.1.1 Introduction

There are three types of static load, as defined in Table 3.1. Descriptions of common static equipment follow.

Table 3.1: Definitions and examples of load types.

Uniformly distributed load (UDL) – kN/m ² (Section 3.1.2)	
Load acting uniformly over relatively large area	Block stacked pallet loads and paper reels (unit loads)
	Loads from fixed machinery and equipment
	Nominal loadings for light commercial and recreational use
Line load (LL) – kN/m (Section 3.1.3)	
Load acting uniformly over extended length	Mobile dense racking systems
	Partition walls Rail mounted fixed equipment
Point load (PL) – kN (Sections 3.1.4 and 3.2)	
Concentrated load from baseplate or wheel	Arena seating
	Clad rack buildings
	Mezzanine legs
	Point loads from fixed machinery
	Stacker crane rail mountings
	Storage racking legs
	Wheel loads from materials handling equipment (Section 3.2)

3.1.2 Uniformly distributed loads

Block stacking

Block stacking usually consists of unit loads, stacked on top of one another. The height of the stack is typically limited to 4 m and is governed either by the crushing resistance of the load or by the stability of the fork-lift truck or stack (see Figure 3.1).

Typically, unit loads are stored on timber pallets, in metal stillages or post pallets. It is usual, for ease of racking installation and block stack stability, to keep unit load dimensions and weight within close tolerances. Rolls of newsprint (Figure 3.2), bales and packaged goods handled by hydraulic clamps rather than forks are also considered as unit loads.

Nominal loadings

Guidance on loadings in light commercial, recreational and other buildings is given in BS 6399-1⁽¹²⁾. Actual loadings in these situations are very low and the design guidance in this report is unlikely to be relevant. Slab thickness is more likely

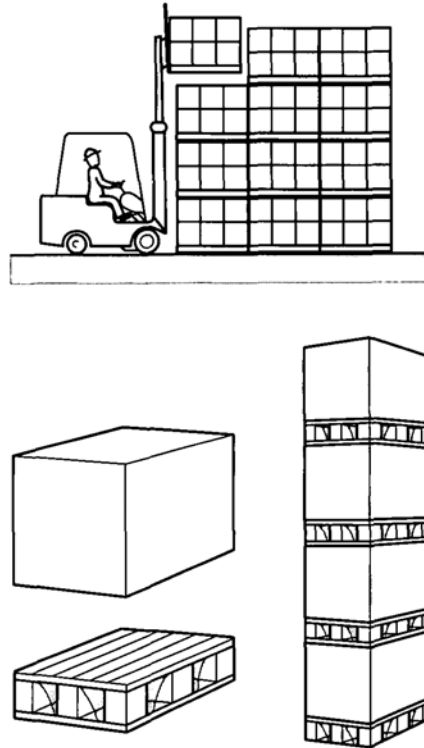

Figure 3.1: Block stacking of unit loads.



Figure 3.2: Rolls of paper are considered as unit loads. Note the heavy-duty dual-wheeled lift truck.

to be governed by practical limitations of constructing very thin slabs and by the need for robustness of the slabs. To put this into context, a slab 150 mm thick will have considerable load-carrying capacity in the order of 50 kN/m² but loads in sports or similar halls will be in the order of just a few kN/m². Clearly, a nominal thickness of concrete would be sufficient for the loads although it should be noted that structures such as temporary arena seating could create more significant point loads. It is suggested that the minimum practical thickness of a slab is 100–125 mm.

Fixed equipment and machinery

Most heavy equipment is mounted on bases independent of the floor. Where it is to be supported by the floor the equipment may be treated as a uniformly distributed load (UDL) or a point load depending on the design of the support. If the machinery is subject to vibration, it may be necessary to consider higher partial safety factors for dynamic loading, see Section 9.6.

3.1.3 Line loads

The most common line loads are from internal partition walls. Some storage systems and other fixed equipment are mounted on rails. Where such rails are loaded along their full length and are in direct contact with the floor, they should be considered as line loads; where such rails are used by moving equipment, they should be considered as point loads. Rails for equipment such as stacker cranes are often mounted on discrete baseplates in which case they should also be considered as point loads.

3.1.4 Point loads

Point loads arise from any equipment or structure mounted on legs with baseplates and from materials handling equipment. The most common static point loads are from storage racking. Loads from MHE are considered in Section 3.2.

Storage racking

Pallet racking and other storage systems enable goods and materials to be stored safely up to considerable heights, while maintaining access to the individual unit loads. Proprietary systems of adjustable pallet racking (APR) consist of braced end frames and beams. The end frames comprise pairs of cold-rolled steel section uprights connected by frame bracing. The beams that support the pallets span between these end frames, see Figure 3.3. The weight of the rack is usually small compared to the weight of the stored goods, but in some circumstances it can be a significant part of the overall load on the floor. Most types of racking distribute the loads approximately equally among the supporting uprights, but some systems such as cantilever racking can result in the stored loads being shared unequally by the uprights. This should be checked with the designer.

Typical end frame depths relate to pallet dimensions, and beam spans are designed to support one or more palletised loads with appropriate operating clearances.

In many installations, the lowest level of palletised loads is stored directly on the floor slab. With trucks that operate with



Figure 3.3: Back-to-back storage racking with 'man-up' stacker trucks operating in narrow aisles. Pallets are deposited at the ends of the racking for collection.

floor guide rails, the lowest level of loads is carried on beams on the racking just above floor level.

In a conventional static racking system, the full bay loading is transmitted to the slab through the baseplates at the foot of the two uprights in each frame, except for the frames at each end of the aisle where only half the full bay loading occurs. Baseplates for racking fed by pallet handling trucks are of limited plan dimensions so they do not intrude into the floor area over which the truck wheels pass or the pallets are deposited. The effective contact area with the floor is therefore limited, and most racking is provided with baseplates for fixing bolts, which are not intended to distribute load. For design purposes, the loaded area is assumed to be 100 × 100 mm, approximating to the size of the uprights of the racking. If it is necessary to spread leg loads over a larger area the strength and stiffness of the baseplates should be checked.

Typical point loads for individual racking baseplates range from 35 to 100 kN. In very high bay warehouses where high-lift rail-mounted cranes are used, as shown in Figure 3.16, point loads can approach 200 kN.

Rows of racking are usually placed back-to-back, with a clearance of 250–350 mm between the inner uprights. Working aisles between the racks allow loading by fork-lift trucks or stacker cranes from either side. Loads from back-to-back racking, as shown in Figure 3.4, are usually the governing case for slab design.

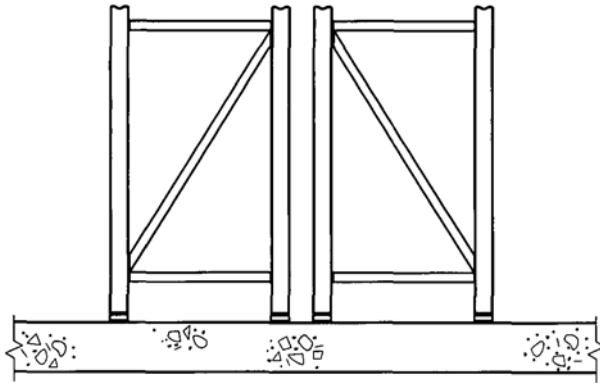

Figure 3.4: Typical 'back-to-back' configuration of storage racking.

Pick and deposit (P&D) stations are marshalling areas at the end of narrow aisles or very narrow aisle racking bays. They can be either marked out on the floor or form part of the racking structure; in the latter case the uprights supporting the P&D stations may carry increased loads.

Mobile pallet racking (see Figure 3.5) consists of sets of racks on mobile chassis running on floor-mounted rails. The racks are individually driven by electric motors so each aisle can be opened up as required for access to individual pallets. Apart from the one access aisle, the whole stack is a block of high-density storage in which over 80% of the floor space can be used.

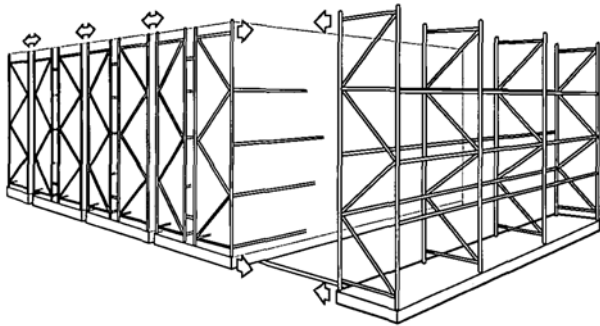

Figure 3.5: Mobile pallet racking.

Laden rack stability usually limits the lift height to 11 m. The racking will apply point loads to the rails. Depending on the stiffness and fixing arrangements of the rails, the load on the floor may be considered as a point load or a line load. If considered as a line load, approximately 150 kN/m can be expected. Acceleration and braking will cause horizontal loads; these will depend on the particular equipment but will be much smaller than the vertical loads and are not normally considered in design. However, the racking manufacturer should be consulted.

Live storage systems (see Figure 3.6), like mobile pallet racking, provide a high-density block of loads but without load selectivity. Incoming palletised loads are placed by fork-lift truck on the 'high' end of a downward sloping set of roller conveyors. As loads are removed from the 'low' end,

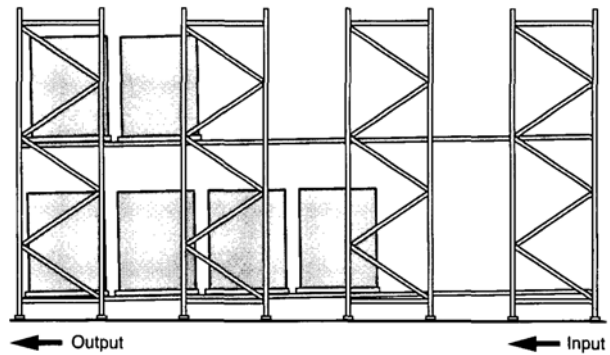

Figure 3.6: Live storage systems.

an automatic latch allows the pallets to move by gravity towards the outlet end of the racking. This type of storage enables stock to be rotated on the first-in, first-out principle. The self-weight of the racking and rollers and the nature of the system may mean that the applied point loads are unequally distributed among the rack uprights. Braking will cause horizontal loads; these will depend on the particular equipment but will be much smaller than the vertical loads and are not normally considered in design. However, the racking manufacturer should be consulted.

With **drive-in (and through) racking** (Figure 3.7) there is no division by aisles. The block of racking can be accessed for load storage and retrieval.

Cantilever brackets attached to the racking frames support pallets. Compared to very narrow aisle (VNA) racking, 50% more of the available space can be used and the height is limited by the strength of the racking. The self-weight and configuration of the racking may mean that the applied point loads are unequally distributed among the rack uprights.



Figure 3.7: Drive-in racking.

Push-back racking systems (Figure 3.8) provide a high density block of loads but with limited load selectivity. Incoming palletised loads are placed by fork-lift truck on the push-back carrier; subsequent loads are positioned on the next available carrier and used to push the previous load

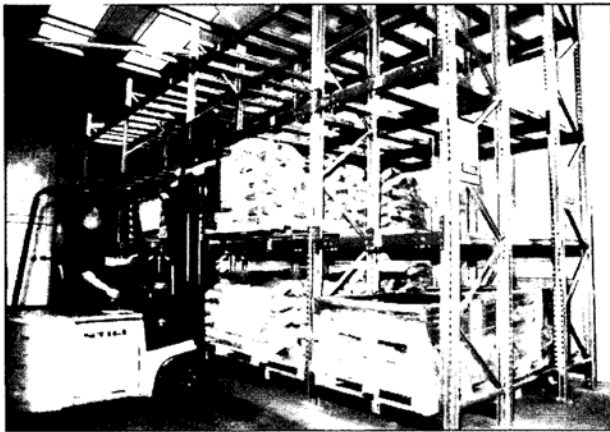

Figure 3.8: Push-back racking.

back up a slope. Typically installations are less than four pallets in depth and are not usually higher than 6 m. Horizontal loads due to braking of the pallets are normally less than 5 kN. This type of storage works on the first-in, last-out principle. The self-weight and configuration of the racking and carriers may mean that the applied point loads are unequally distributed among the rack uprights.

Cantilever racks (Figure 3.9) can store long loads, so they are sometimes referred to as 'bar racks'. The racks consist of a row of uprights with arms cantilevering out on either or both sides and are often used in conjunction with side-loading fork-lift trucks. They are not usually higher than 8 m, but as they often store heavy products can be quite heavily loaded.



Figure 3.9: Cantilever racking.

Mezzanines (raised platforms)

Mezzanines (see Figures 3.10 and 11) are commonly used for production, assembly and storage. Leg loads can be in excess of 200 kN and baseplates should be designed to provide the required load-spreading capability. Additional slab reinforcement or discrete foundations may be required.

Clad rack structures

In clad rack structures (Figure 3.12) the racking itself provides the structural framework for the building and

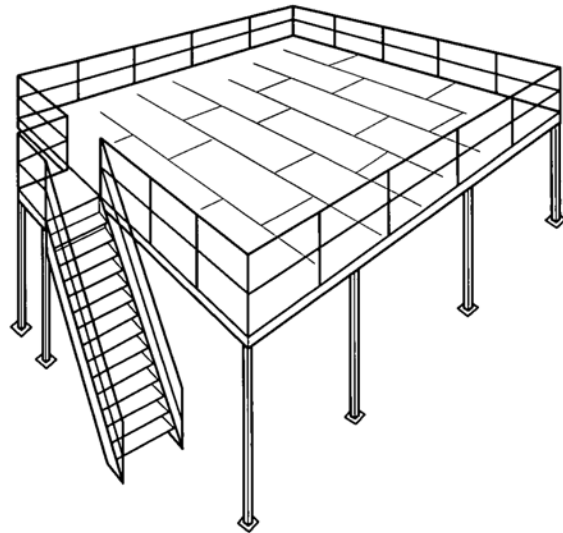

Figure 3.10: Mezzanine (raised platform).



Figure 3.11: Mezzanine used for access to storage, with racking below.

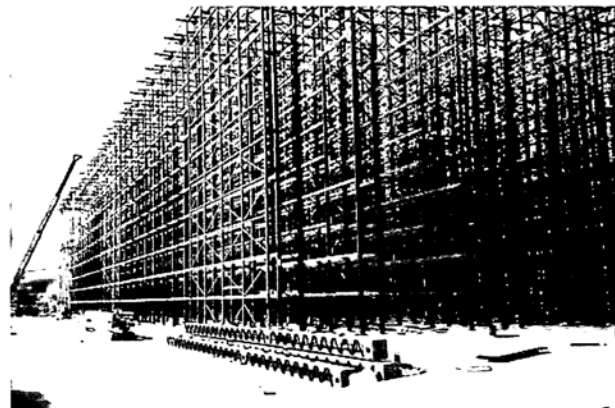

Figure 3.12: Clad rack system.

supports the walls and roof. Clad rack warehouses can cover any area and be up to 45 m high. It is not possible to give typical point loads from these structures onto the floor slab as each application will depend upon the size of building, the goods to be stored as well as wind and snow loads. Clad rack design and construction is a specialist field and expert advice should be sought.

With this form of construction, the floor slab acts as a raft foundation to the entire structure. As the slab is constructed in the open air with no protection from the elements, surface defects are more likely.

3.2 MATERIALS HANDLING EQUIPMENT

3.2.1 Introduction

Materials handling equipment (MHE) is used for moving pallets and containers and for bulk products such as paper reels and timber. It is also used for order picking where individual items are collected from storage and packed for dispatch to customers or for use in nearby production facilities.

All MHE generates point loads. In order to design floors to support these loads, the maximum wheel loadings and contact areas of wheels or tyres must be known. Equipment configurations and weights vary significantly and so manufacturers should be consulted.

MHE loads are dynamic, and this is a significant design consideration, see Section 9.6.

3.2.2 MHE operating at floor level

Pallet transporters and trailers are used at floor level for moving single or multiple pallets and for order picking. They can be controlled by pedestrians alongside or operators riding on them (Figure 3.13). Truck capacities do not usually exceed 3 tonnes, but can be higher in specialist applications. The trucks have small load-carrying wheels (normally polyurethane) and so local load concentrations can be high.

Floor surfaces on which this equipment operates should be flat and have a good but not onerous standard of levelness. See Chapter 4 for explanations of the classification and specification of floor flatness and levelness.

Joints in floors are prone to damage by the small wheels on this type of equipment. Sawn restrained-movement joints give good service provided the openings are limited in size and the joints are properly maintained, see Chapters 8 and 13. Free-movement joints are generally wider and consideration should be given to steel armouring of the joint arrises, see Section 8.9.

Where this type of equipment is used intensively, such as in food distribution, consideration may be given to 'jointless' slab construction, see Sections 2.2.2 and 8.9. It should, however, be noted that free-movement joints are provided at intervals of about 50 m in such floors and that these joints will be relatively wide (up to 20 mm).

In such operations, the user will need to decide between more narrow joints at about 6 m intervals and fewer, wider joints. However, the armoured jointing systems that are often used in jointless construction could be provided with filler plates installed later after shrinkage of the concrete slab has taken place, allowing narrow joints to be incorporated.

The operation of some types of mobile equipment can be aggressive on floor surfaces and cause abrasion and other



Figure 3.13: The small wheels on pallet trucks (such as that in the foreground) can be damaging to joints in floors.

surface damage. The main cause of damage is likely to be the scraping of pallets, particularly when they are in poor condition, across the surface when they are being picked up or deposited. This is discussed in Chapter 5.

3.2.3 MHE operating in free-movement areas and wide aisles

Counterbalance trucks

Counterbalance trucks are fork-lift trucks fitted with telescopic masts with the load carried ahead of the front (load) wheels (Figure 3.14). They are used within buildings and externally for block stacking, in storage racking up to about 7 m high and for general materials movement. Because they approach stacking and racking face on, aisle widths for counterbalance trucks are at least 4 m. Load-carrying capacity of the trucks can be 10 tonnes or more, but in industrial buildings loads do not usually exceed 3 tonnes. Lift heights are limited by stability and do not normally exceed 7 m.

Truck tyres are either solid rubber or pneumatic. All tyres can be aggressive on dusty or wet floor surfaces. It is important to keep floors clean to avoid such conditions. Counterbalance trucks can tolerate relatively uneven surfaces and joints. See Chapter 4 for explanations of the classification and specification of floor flatness and levelness.

Reach trucks

Reach trucks have moving telescopic masts and transport the load in a retracted position within the truck wheelbase (Figure 1.2). They can operate in narrow aisles up to 3 m wide and have a typical load capacity of 2 tonnes. Lift heights do not normally exceed 10–12 m. They can be used for order picking and can also operate in free-movement areas.

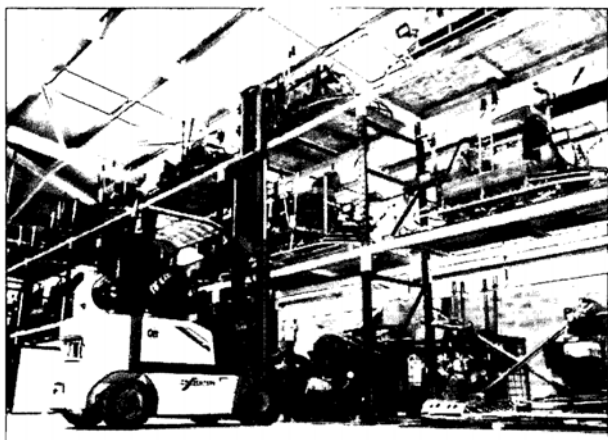

Figure 3.14: Counterbalance truck.

Truck tyres are generally made of hard neoprene rubber with wheel diameters of 200–350 mm. The wheels are not unusually aggressive to surfaces. Floor surfaces should be flat and level with no wide, stepped or uneven joints. See Chapter 4 for explanations of the classification and specification of floor flatness and levelness.

3.2.4 MHE operating in very narrow aisles

Front and lateral stackers

These lift trucks can pick or place pallets at right angles to the direction of travel and are also known as very narrow aisle (VNA) trucks. Operators travel at floor level or in a compartment that lifts with the forks: these are known as ‘man-down’ and ‘man-up’ trucks respectively (see Figure 3.15). They are also used for order picking. Truck tyres are made of hard neoprene rubber. As the trucks operate on fixed paths, the wheels do not ‘scuff’ laterally and therefore are not unusually aggressive to surfaces.

In very narrow aisles, trucks run in defined paths and so it is appropriate to measure and control the flatness in each of the tracks. Most trucks have three wheels, two on the front load axle and one drive wheel at the rear. Some have two close-coupled wheels at the rear acting as one wheel. A few trucks have four wheels with one at each ‘corner’. When operating in the aisles, the trucks are guided by rails at the sides of the aisle or by inductive guide wires in the floor and are not directly controlled by the operator.

The inclusion of inductive guide wires in the slab may affect its design thickness, see Section 9.8. Guide wires need to be kept clear of steel reinforcement bars. Steel fibres in concrete do not normally affect guidance systems. See Sections 7.2–7.4.

Some floor-running stackers have fixed non-retractable masts and run between top guidance rails that can also provide power to the truck through a bus-bar system. These systems are designed to provide some restraint to sideways movement of the mast to effectively stiffen it. Contrary to some expect-



Figure 3.15: ‘Man-up’ stacker truck in a very narrow aisle warehouse.

tations, these systems are not designed to compensate for inadequate floor flatness.

Floor surfaces should be flat and level with no wide, stepped or uneven joints. Floors are specified with a defined-movement classification that depends on the maximum height of lift, as defined in Section 4.4 and Table 4.3.

Stacker cranes

Stacker cranes run on floor-mounted rails (Figure 3.16). They have fixed masts with a top guidance rail and can transfer between aisles by means of special rail links. There are no onerous floor flatness requirements as the rails are set level with shims. However, the floor should have a good overall level to datum as the racking and rails are fixed level to a datum. Limiting long-term settlement of slabs is important for stacker crane installations as changes in levels can lead to operational problems.

3.3 CLASSIFICATION OF FLOOR LOADINGS

In the review for this edition of TR 34, consideration was given to providing new advice on typical loading classifications as these are thought to have increased above those described in the widely used BRE Information Paper IP19/87⁽⁴⁾.

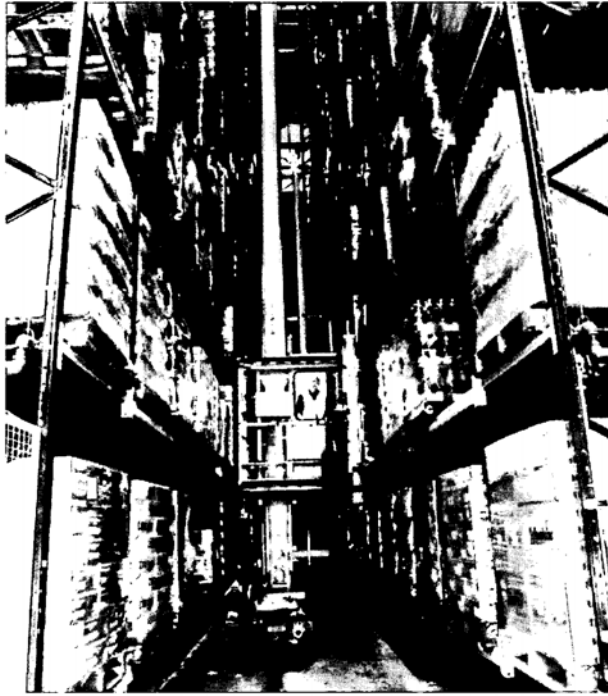

Figure 3.16: Stacker crane, running on a floor-mounted rail.

It was suggested that the system of classification should be revised at some time in the future following further research. It is recognised that any such changes would require careful implementation and adequate publicity to minimise confusion in the industry.

It is strongly recommended that the existing classifications should be used with caution, particularly for more heavily loaded floors with combinations of high point loads from racking and MHE. The BRE Information Paper suggests that loadings from MHE are unlikely to be critical, but this may not be the case in mixed-use floors where heavy counter-balance trucks operate or in some VNA installations where point loads from stacker trucks can be significant. The recommended approach is to design for the particular application. The model design brief in Appendix A can be used for this purpose.

4 SURFACE REGULARITY

4.1 INTRODUCTION: THE IMPORTANCE OF SURFACE REGULARITY

The surface profiles of a floor need to be controlled so that departures in elevation from a theoretically perfectly flat plane are limited to an extent appropriate to the planned use of the floor. For example, high-lift materials handling equipment requires tighter control on surface regularity than a low-level factory or warehouse. Inappropriate surface regularity of a floor may result in equipment having to be operated more slowly, reducing productivity, or requiring increased maintenance.

Possible surface profiles are illustrated in Figure 4.1. The elevational differences are emphasised for the sake of illustration: on a real floor the differences will be in the order of a few millimetres measured over a distance of several metres.

Surface regularity needs to be limited in two ways. The floor should have an appropriate flatness in order to limit, for

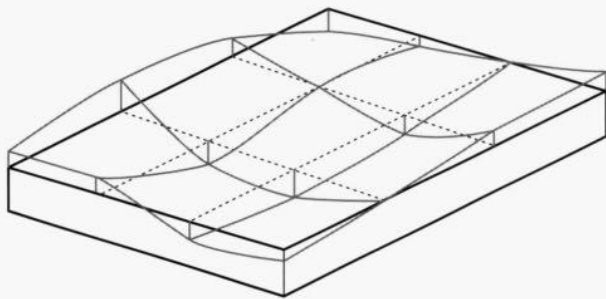

Figure 4.1: Surface profiles.

example, the bumpiness and general stability in operation of the materials handling equipment, and an appropriate levelness to ensure that the building as a whole with all its static and mobile equipment can function satisfactorily. The difference between flatness and levelness of floors is illustrated in Figure 4.2.

It can be seen that flatness relates to variations over short distances whereas levelness relates to longer distances. These distances are not easily definable but traditionally, flatness has been controlled over a distance of 300 mm and levelness over a distance of 3 m as well as to a building's general datum.

Flatness is a function both of the elevational difference and of the rate at which elevational differences change across a floor.

The terms used for defining the various aspects of surface regularity are set out in Table 4.1. Figure 4.3 shows examples of how some of these are derived.

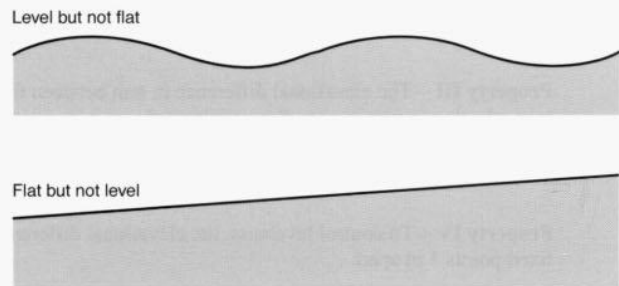

Figure 4.2: Flatness and levelness.

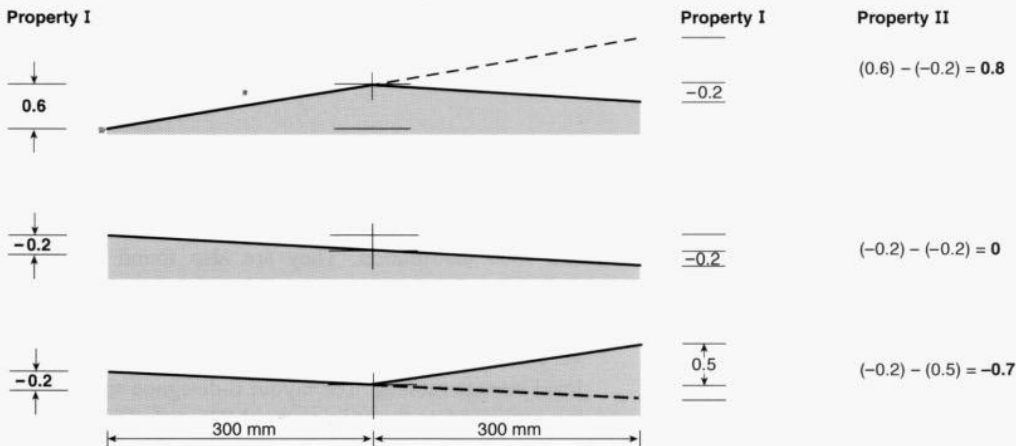
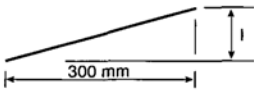
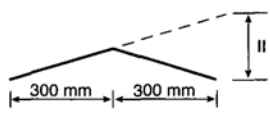
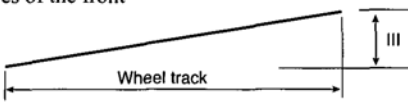
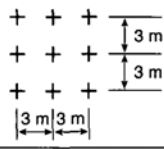

Figure 4.3: Examples of measurements of Property I over 300 mm and the resultant determination of change in elevational difference over a distance of 300 mm (Property II). All dimensions in mm.

Table 4.1: Definition of surface regularity terms.

Term and definition	Section
<p>Elevational difference The distance in height between two points. The points can be fixed at prescribed distances or they can be moving pairs of points at prescribed distances apart.</p>	Figure 4.3
<p>Change in elevational difference The change in the elevational difference of two moving points, at a prescribed distance apart, in response to a movement of the two points over a prescribed distance.</p>	Figure 4.3
<p>Datum The level of the floor is controlled to datum (any level taken as a reference point for levelling).</p>	
<p>Flatness Surface regularity characteristics over a short distance, typically 300 mm.</p>	Figure 4.2
<p>Levelness Surface regularity characteristics over a longer distance, typically 3 m, and to datum.</p>	Figure 4.2
<p>Property Elevational differences or measurements derived from elevational differences that are limited for each class of floor.</p> <p>Property I – The elevational difference in mm between two points 300 mm apart, see also Figure 4.3.</p>  <p>Property II – To control flatness, the change in elevational difference between two consecutive measurements of elevational difference (Property I) each measured over 300 mm, see also Figure 4.3.</p>  <p>Property III – The elevational difference in mm between the centres of the front load wheels of materials handling equipment.</p>  <p>Property IV – To control levelness, the elevational difference in mm between fixed points 3 m apart.</p> 	Sections 4.3 and 4.4
<p>MHE Materials handling equipment</p>	Chapter 3
<p>VNA Very narrow aisle</p>	Figure 4.5

4.2 FLOOR TYPES: FREE AND DEFINED MOVEMENT

Introduction

In warehouses, materials handling equipment is used in two distinct areas: areas of free-movement traffic and areas of defined-movement traffic:

- In **free-movement areas**, MHE can travel randomly in any direction, see Figure 4.4. Free-movement areas typ-

ically occur in factories, retail outlets, low-level storage and food distribution. They are also found alongside defined-movement areas in warehousing.

- In **defined-movement areas**, vehicles use fixed paths in very narrow aisles: they are usually associated with high-level storage racking. The layout is designed specifically to accommodate the racking and MHE only (Figure 4.5).

Distribution and warehouse facilities often combine areas of free movement for low-level activities such as unloading and



Figure 4.4: A free-movement area: marks from the rubber tyres of the materials handling equipment may be seen.

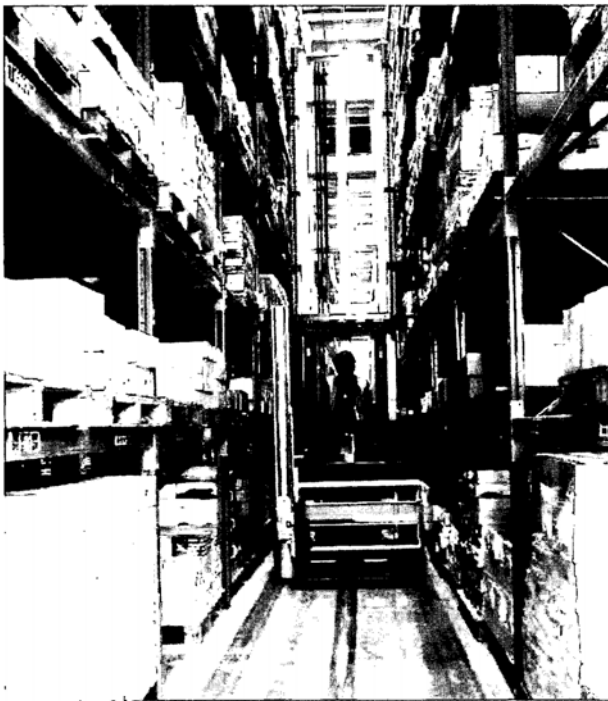

Figure 4.5: A defined-movement area in a very narrow aisle.

packing alongside areas of defined movement for high-level storage.

The two floor uses require different surface regularity specifications so that appropriate performance of the floor can be achieved at an economic cost. The different specifications are reflected in the survey techniques used and the limits on measurements (properties) that are prescribed.

Free-movement areas

In assessing the surface regularity of free-movement areas, a sample of points on the floor is surveyed, as it is not practical to survey the infinite number of combinations of points on the floor. Unlike in defined-movement areas, it is not necessary to control every point with precision as MHE is generally operating with loads at low level and there is minimal risk of collision with storage racking at high level as a result of the floor being uneven.

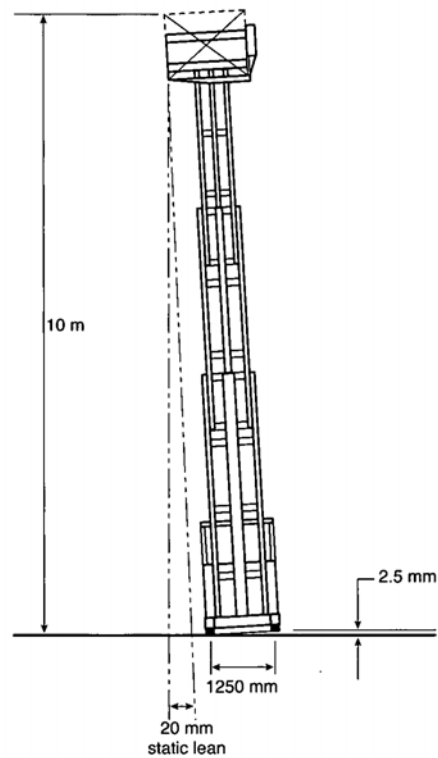

Figure 4.6: Static lean.

Defined-movement areas

Defined movement usually occurs in very narrow aisles or drive-in racking. In these aisles, the regularity of the floor is a critical factor in the performance of the MHE.

Poor surface regularity increases the risk of collision between the truck and the racking, causes driver fatigue and forces materials handling equipment to be operated at lower speeds. Stresses can be created in the mast and body of the truck that cause premature failure of welds and disrupt the performance of electronic components.

Figure 4.6 shows the static lean and how the variation in floor level across an aisle between the wheel tracks of a truck is magnified at the top of the mast in direct proportion to its height. Variations in level also induce dynamic movements in the mast that can magnify the static lean by factors as great as 3 to 4.

Although only the surface regularity in the aisles will be measured, it should be noted that areas that are under racking are constructed at the same time as the aisles but cannot be specified as defined-movement areas. Construction methods for defined-movement areas are normally only intended to provide the required tolerances in the predetermined MHE wheel tracks.

If the precise positions of the aisles between the storage racking in warehouses are not known at the time of floor construction, it is **not** appropriate to specify the surface regularity of the aisles as defined-movement areas. In these cases, a free-movement specification may be considered. It should be emphasised that it is always best to build to meet the needs of the final aisle layout as the techniques for constructing to the

tolerances required for defined movement in pre-planned aisles may not be economically or practically applied over large indeterminate areas. Section 4.7 discusses the conversion of free-movement areas to defined-movement specifications.

Areas away from racking such as goods in and out and transfer areas should be regarded as free-movement areas.

4.3 SURFACE REGULARITY IN FREE-MOVEMENT AREAS

Features measured

Two features are measured in free-movement areas: Property II and Property IV, as defined in Table 4.1. In addition, the level of the floor is controlled to datum.

Sampling

It is impossible to survey the infinite number of possible traffic paths in a free-movement area and therefore the elevations of a representative sample of points on the surface of the floor are

measured on a 3 m grid. Areas within 1.5 m of a wall, column or other existing structure are not usually surveyed, as they are likely to have been constructed to match in with the adjacent features. The surface regularity of these small strips may therefore be different to the rest of the floor.

Property II is measured across a sample of the grid lines used to measure Property IV. The minimum total length of survey lines in metres is calculated as the floor area in square metres divided by 10. The lines should be distributed uniformly across the floor with the total length of lines in each direction proportional to the dimensions of the floor. This uniformity ensures that the survey gives an assessment of a reasonable sample of the free-movement area.

Property IV is measured between all adjacent survey points on the grid.

Surveying techniques

Property II is usually measured using specialist digital equipment that has been developed for this purpose. Property



(a) Optical level for measuring Property IV and datum.



(b) Dipstick for measuring Properties I and II.



(c) Digital instrument measuring Property II in free-movement area.

Figure 4.7: Floor surveying equipment.

Table 4.2: Permissible limits on Properties II and IV in free-movement areas.

Floor classification	Typical floor use	Property II limit (mm)		Property IV limit (mm)	
		95%	100%	95%	100%
FM 1	Where very high standards of flatness and levelness are required. Floors to FM 1 classification may need to be constructed using long strip methods. See Section 2.2.3	2.5	4.0	4.5	7.0
FM 2	Buildings containing wide aisle racking with stacking or racking over 8 m high, free-movement areas and transfer areas	3.5	5.5	8.0	12.0
FM 3	Buildings containing wide aisle racking with stacking or racking up to 8 m high Retail and manufacturing facilities	5.0	7.5	10.0	15.0

For all classifications, all points surveyed should be within 15 mm from datum.

IV is measured using a precise level and staff, or other method with appropriate accuracy, see Section 4.5. These techniques are illustrated in Figure 4.7.

Data analysis and permissible limits

The survey data is analysed and compared with the permissible limits for Properties II and IV given in Table 4.2.

The floor is non-compliant if:

- more than 5% of the total number of measurements exceed the 95% property limit
- any measurement exceeds the 100% property limit, and
- any point on the Property IV survey grid is outside ± 15 mm of datum.

Choosing the floor classification

Generally, the higher the classification specified, the greater the potential cost of the floor. Requirements for tighter flatness tolerances may also lead to construction methods with more formed joints, see Chapter 2. However, construction techniques and their associated tolerances are constantly developing and contractors should be consulted to find the best combination of construction technique (particularly the jointing plan), surface regularity and cost to suit the planned use.

Free-movement floors and associated construction tolerances are not intended for very narrow aisles, where a defined-movement specification should be used. If a development must proceed without detailed information on the racking layout then it is recommended that the classification 'FM 2 (Special)', as defined in Table 4.4, is used. Advice on conversion of free-movement floors to defined-movement floors is given in Section 4.7. It should be noted that FM 2 (Special) tolerances are onerous and are thought to represent the highest standards achievable with current large area construction methods, see Sections 2.2.1 and 2.2.2. Some grinding is likely to be required in the defined-movement areas, once they are known.

This specification is not required for typical low-level use, where FM 2 is satisfactory. Generally, the FM 2 (Special) should be considered only where VNA storage racking with top rail heights above 8 m is to be installed. Building heights to accommodate such racking will typically be 10 m to eaves.

Non-compliance

In free-movement floors, it is not possible to measure or control the relationship between all of the infinite combinations of points on the floor. For this reason, a sample of the points on the surface of the floor is assessed. The data is analysed and the number of measurements of each Property that fall within the limits shown in Table 4.2 are calculated as percentages of the total number of measurements taken.

Where more than 5% of the measurements are greater than the 95% limit or where any measurements are greater than the 100% limit, it is recommended that the individual mea-

surements are examined in detail to determine their significance before any remedial measures are considered. Minor variations are unlikely to affect the performance of a floor and remedial actions such as surface grinding will affect the appearance of the floor, particularly where a dry shake finish has been used.

Regularity across joints in free-movement areas

Joints create unavoidable discontinuities in floors. The effect of these discontinuities depends on the specific operational requirements of the floor. Different joint types can give different levels of performance and this performance may itself change over time. The guidance given here is intended primarily for newly constructed floors but could be used to assess the condition of older floors.

On new floors, sawn joints do not usually affect surface regularity. Formed joints at the edges of long strip construction or around large area construction may have more effect. Formed joints consist of simply abutted slabs or slabs with arrises strengthened by proprietary steel armouring systems, see Section 2.2 and Chapter 8.

Formed joints in new floors and any joint in an older floor can affect surface regularity in three ways.

- width of the joint opening
- magnitude of any step at the joint
- change in elevational difference (Property II) across the joint.

Assessing performance criteria and the associated tolerances is therefore complex – this area has not been adequately researched.

All of the above factors can change with time. The dynamic action of materials handling equipment can affect the performance of the joint; these effects may become more pronounced over time, particularly where there is a lack of load-transfer capacity or loss of subgrade support. In addition, movement is to be expected at all joints because of shrinkage.

Where the performance of a joint is considered to be critical, it is suggested that specific details are agreed before construction, based on independent specialist advice.

Maintenance of joints and joint sealants (or more specifically, lack of maintenance) can have a significant effect on the performance of the joints; see Section 8.12 and Chapter 13.

4.4 SURFACE REGULARITY IN DEFINED-MOVEMENT AREAS

This section provides current guidance on controlling surface regularity in defined-movement areas. An alternative method is under development in the UK and is given in Appendix C.

Features measured

Three features are measured in the two front (load-carrying) wheel tracks: Property I, II and III, as defined in Table 4.1. In addition, the level of the floor is controlled to datum.

Sampling

Aisles are surveyed over their full lengths. The survey should extend beyond the first rack leg, out into the transfer aisles or the adjacent free-movement area, to a distance that is designed to take into account the use of the area by the MHE of any fixed high-level equipment such as bus bars or top guide rails. For compliance purposes each aisle is considered separately.

Surveying techniques

Properties I, II and III are commonly measured using a profileograph, see Figure 4.8, which produces continuous or semi-continuous readings.

Data analysis and permissible limits

The survey data is analysed and compared with the permissible limits for Properties I, II and III given in Table 4.3. The analysis of data should be made on each aisle individually. The floor is non-compliant if:

- more than 5% of the total number of measurements in any aisle exceed the 95% property limit
- any measurement in any aisle exceeds the 100% property limit, and



Figure 4.8: Profileograph in use in an aisle.

- any point of the floor is outside ± 15 mm of datum.

It is not possible to specify and impose these limits for defined movement unless the precise positions of aisles are known before construction.

Choosing the floor classification

Classifications of floors based on MHE lift heights are given in Table 4.3 along with permissible limits on Properties I, II and III.

When deciding on the classification, it should be recognised that, apart from a higher potential cost of the floor, the requirement for higher flatness tolerances may lead to construction methods with more formed joints, see Chapter 2. An unnecessarily high classification should not be selected. However, construction techniques and associated tolerances are constantly developing and contractors should be consulted to find the best combination of construction technique (particularly the jointing plan), surface regularity and cost to suit the planned use.

Non-compliance

When floors are constructed using techniques that are appropriate to the floor classification, nearly all measurements can be expected to be within the limits shown in Table 4.3. Where limits are exceeded, it may be possible to grind the high areas of the surface or, in unusual circumstances, to fill the low areas of the surface. This should be done only when the MHE wheel-track positions are confirmed and ideally after the racking has been installed to avoid the risk of misalignment. If wheel tracks have been ground or filled the wheels should be in full contact with the floor surface so that no transverse thrust or other stresses on wheels are created, see Figure 4.9.

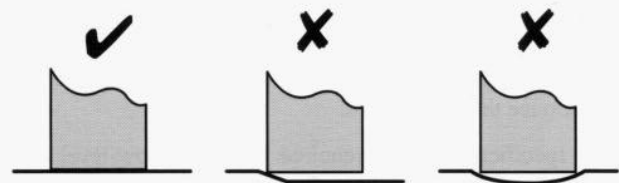

Figure 4.9: Remediation in wheel tracks.

Table 4.3: Permissible limits on Properties I, II and III in defined-movement areas.

Floor classification	MHE lift height	Property I		Property II		Property III			
		95%	100%	95%	100%	Wheel track up to 1.5 m		Wheel track over 1.5 m	
						95%	100%	95%	100%
Superflat (SF)	Over 13 m	0.75	1.0	1.0	1.5	1.5	2.5	2.0	3.0
Category 1	8–13 m	1.5	2.5	2.5	3.5	2.5	3.5	3.0	4.5
Category 2	Up to 8 m	2.5	4.0	3.25	5.0	3.5	5.0	4.0	6.0

For all classifications, all points surveyed should be within 15 mm from datum.

Where grinding is required in any aisle, 100% of all final measurements in that aisle should fall below the 100% limit and 95% of all final measurements in that aisle should fall below the 95% limit. The floor grinder will be able to decide which points are left at the 100% limit; it is recommended that, where practical, these higher value Property points are at the ends of aisles.

Grinding (Figure 4.10) will affect the appearance of the floor, particularly where a dry shake finish has been used to enhance appearance.

Regularity across joints in defined-movement areas

All transverse joints across aisles in defined-movement areas are included in the standard survey method. Longitudinal joints are usually situated beneath racking and are not subject to trafficking by MHE.

4.5 SURVEY PRACTICE FOR ALL FLOOR TYPES

Accuracy of surveys

Information on the accuracy of conventional surveying methods can be found in Table 3 of BS 5606: 1990 ⁽¹³⁾. Methods of testing conventional surveying equipment are covered in BS 7334 ⁽¹⁴⁾.

Profilegraphs and other digital equipment, which are commonly used for surveying large floor areas, are specialist equipment operated by a limited number of specialist contractors. There is no standard for the calibration of such equipment and surveying contractors should satisfy clients that it is calibrated by an appropriate method.

Timing of surveys

Survey assessment of the surface regularity of the whole floor should be made within one month of completing the

whole floor or major sections of it to check that 'as-built' it complies with the specification. It is common to survey sections of floor in large developments as they become available and before other trades move in, rendering them inaccessible.

For purposes of quality control, assessments can be made at any stage in the construction to check that the completed floor will meet the specification.

4.6 CHANGE OF FLOOR FLATNESS WITH TIME

Surface regularity can change over time for the three main reasons discussed below.

Floors deflect under load. Designers should check that the expected deflections are compatible with the levelness and flatness required. Deflections under point loads on ground-supported floors can be calculated using the procedure set out in Section 9.12.2. Deflections in pile-supported slabs should be estimated in accordance with BS 8110 ⁽¹⁵⁾ or the draft Eurocode 2 ⁽¹⁶⁾.

Unexpected settlement of the ground or of piles may affect the levelness and flatness of a floor. Such settlement could occur because the appraisal of the soil on the site did not assess its characteristics accurately or because the soils treatment programme was inadequate, see Section 6.3.

Levelness and flatness can change at the edges or corners of floor panels as a result of curling, see Section 5.7. Curling is caused by the differential shrinkage of the concrete. The exposed top surface dries and shrinks more than the bottom, causing the floor to curl upwards. This can occur at any time up to about 2 years after construction. Curling cannot be totally eliminated and tends to be unpredictable. However, it is a function of shrinkage and it is therefore prudent to limit the shrinkage potential of the concrete (see Section 10.3.2).

4.7 CONVERTING FLOORS TO DEFINED-MOVEMENT SPECIFICATIONS

As noted in Section 4.2, if a building is intended for high racking with very narrow aisles it is inadvisable to design the floor to meet a free-movement specification. This practice sometimes occurs in 'speculative' developments where a tenant and the required floor layout have not been identified. It is recommended that floors are not constructed until the final layout has been designed.

Older floors are often upgraded to defined-movement use when the use of a building changes. It is recommended that



Figure 4.10: Typical grinding operations.

floors are surveyed as part of the planning process for such upgrading in order to establish the extent of the grinding or other work required to enable the floor to meet the required surface regularity tolerances.

There are significant differences between the tolerances for free-movement areas and defined-movement areas. Before conversions are contemplated, the tolerances of the required defined-movement specification should be compared with the tolerances of the proposed or existing free-movement specification to assess feasibility. For example, one difference in requirements between Category 1 and FM 2 is as

follows: Property III for a Category 1 floor requires an elevational difference of 2.5 mm over a distance of 1.5 m. This should be contrasted with the permitted elevational difference of 8 mm over 3 m of Property IV in FM 2. This latter tolerance can equate at best to 4 mm over 1.5 m and possibly up to 8 mm over 1.5 m.

In speculative construction, the developer is advised to build to as high a standard as possible. Surface regularity specification FM 2 (Special), see Table 4.4, is suggested to reduce the amount of grinding required for Category I use once the defined-movement areas have been defined.

Table 4.4: Permissible limits on Properties II and IV in floors for possible conversion to Category 1.

Floor classification	Floor use	Property II limit (mm)		Property IV limit (mm)	
		95%	100%	95%	100%
FM 2 (Special)	Floors for possible conversion to Category 1 defined-movement.	3.0	4.5	6.5	10.0

5 FLOOR SURFACE REQUIREMENTS

5.1 INTRODUCTION

This chapter is intended to help specifiers to understand what can be expected of floor surfaces, to evaluate the significance of particular features in completed floors and, where necessary, to decide on appropriate action. Requirements relating to surface regularity are discussed separately, in Chapter 4. Grinding used to create surface regularity will not usually affect the use of the floor but will affect its appearance, and wholly or partially remove any surface treatment such as a dry shake finish.

Wherever possible, contract specifications should give specific criteria to be achieved. However, some floor characteristics are not easily defined and their descriptions can be open to interpretation. Contract specification details should not be finalised until the owner's or user's expectations have been established, the contractor has demonstrated that they are practicable and have been agreed by all parties concerned.

5.2 ABRASION RESISTANCE

Abrasion resistance is the ability of a concrete surface to resist wear caused by rubbing, rolling, sliding, cutting and impact forces. Wear, which is the removal of surface material, is a process of displacement and detachment of particles or fragments from the surface. Abrasion mechanisms are complex and combinations of different actions can occur in many environments, for example, from truck tyres, foot traffic, scraping and impact. Excessive and early wear can be caused by the use of under-specified or under-strength concrete or water damage at the construction stage. Tests are available to measure the abrasion resistance of concrete.

Guidance on performance classes, service conditions and typical applications, together with recommended abrasion resistance test limits, is given in Table 4 of BS 8204-2: 2002⁽¹⁰⁾. Part of this Table is adapted and reproduced in Table 5.1.

The required abrasion resistance should be specified in relation to the service conditions. Differentiating between the service conditions described may be difficult. In practice, many floors will have a combination of uses, particularly when a variety of truck types operate on the floor. It is very common, for example, to find trucks with steel and plastic wheels operating together and also to find rubber-tyred counterbalance trucks operating in certain areas of a floor.

It should be noted that, while this report adopts the performance class structure and test limits of BS 8204-2⁽¹⁰⁾, the recommendations for achieving the abrasion resistance required are different, see Sections 10.5 (in relation to construction and concrete specification) and 11.2.2 (in relation to aggregates used in concrete).

Inadequate abrasion resistance can be improved by in-surface resin sealers. In more serious cases, mechanical removal of the surface, and the provision of a coating or screed, may be required.

5.3 CHEMICAL RESISTANCE

Chemical attack on concrete floors usually arises from the spillage of aggressive chemicals. The intensity of attack depends on a number of factors, principally the composition and concentration of the aggressive agent, the pH and permeability of the concrete, and the contact time.

Examples of common substances that may come into contact with concrete floors are acids, wines, beers, milk, sugars, and

Table 5.1: Performance classes for abrasion resistance, based on Table 4 of BS 8204-2: 2002.

Performance class	Service conditions	Typical applications	BS 8204 test limits (mm)
Special	Severe abrasion or impact from steel or hard nylon or neoprene wheeled traffic or scoring/scraping by dragging metal objects	Waste transfer stations, foundries, heavy engineering and other very aggressive environments	0.05
AR1	Very high abrasion; steel or hard nylon or neoprene-wheeled traffic and impact. Rubber-tyred traffic in areas subject to spillage of abrasive materials.	Production, warehousing and distribution	0.10
AR2	High abrasion; hard nylon or neoprene wheeled traffic.		0.20
AR3	Moderate abrasion; rubber-tyred traffic	Light duty manufacturing, commercial, sporting and recreational uses	0.40

mineral and vegetable oils. Commonly encountered materials that are harmful to concrete are listed in Concrete Society Technical Report 54⁽¹⁷⁾ and a more comprehensive listing is given in a Portland Cement Association guide⁽¹⁸⁾.

Any agent that attacks concrete will eventually cause surface damage if it remains in contact with the floor for long enough. Although frequent cleaning to remove aggressive agents will reduce deterioration, repeated cycles of spillage and cleaning will cause long-term surface damage, see Section 10.6.

Where chemical attack is likely, consideration should be given to protecting the floor with a chemically resistant material or system that will resist the action of the aggressive agent. Advice on resin coatings is available in BS 8204-6⁽¹⁹⁾ and from specialist suppliers and applicators.

5.4 COLOUR AND APPEARANCE

Concrete floors are constructed primarily from naturally occurring materials and finished by techniques that cannot be controlled as precisely as in a factory production process. The final appearance of a floor will never be as uniform as a painted surface finish. However, some features of a concrete floor that are visible in the first few weeks after it has been cast relate to the drying of the floor and become less visible with time. More care is needed at finishing stages when appearance is important, see Section 12.5.

Floors can be constructed with a 'dry shake finish' as a thin topping layer, see Section 11.4. These sometimes include pigments to give colour to the finished surface. However, these do not give the uniformity or intensity of colour of a painted finish and the same appearance considerations apply to these finishes as to ordinary concrete. Floor users are recommended to inspect existing floors in use to evaluate the benefits of such finishes and the effects that can be achieved.

For bold and consistent colour, it is necessary to use a surface coating or paint. On-going maintenance will then be required.

5.5 CRACKING

Cracking occurs when the tensile stress in a section of slab exceeds the tensile strength of the concrete. This situation most often occurs when the long-term drying shrinkage of the slab is restrained for some reason. Such cracks do not generally have any structural significance. Less commonly however, cracks can occur because of overloading or structural inadequacy, and some restraint-induced cracks could have structural implications because of their position in relation to applied loads. Many factors affect the formation of restrained shrinkage cracks and it is difficult to be certain that a floor will be completely crack-free.

Investigation of the cause of cracking is always required before any treatment; the designer and contractor should pay particular attention to isolation details such as manholes, re-entrant corners or columns that may cause restraint to

shrinkage. Early loading of slabs as part of fast-track programmes can cause pinning of the slab to the sub-base, which may restrain shrinkage and cause cracking.

Concrete Society Technical Report 22, *Non-structural cracks in concrete*⁽²⁰⁾, gives detailed guidance on non-structural cracking, its causes, evaluation and treatment.

Fine cracks may be of concern in terms of appearance, and they should be monitored as part of the floor inspection and maintenance regime. If the arrises of a crack begin to spall or the crack widens, it should be treated to avoid further deterioration. However, this should be balanced against a need to leave new cracks untreated until they have become dormant i.e. not opening any further. Where cracks are not dormant and it is considered essential to provide some degree of arris support, then semi-flexible sealants should be used. See Section 8.12.

If it is suspected that cracking has been caused by some structural deficiency, a careful reassessment of the design must be made before any evaluation of remedial action is made.

5.6 CRAZING

Crazing is common on most power-finished floors. It tends to be more visible on floors that are wetted and cleaned as the extremely fine cracks trap moisture and dust. Crazing is considered to be a matter of appearance only, and generally no structural or serviceability issues are associated.

The mechanisms of crazing in floors are not fully understood but it is known that the surface zone consists predominantly of mortar paste. In power-finished floors, this paste is intensively compacted by the trowelling process and can have a very low water/cement ratio. As the mechanism is poorly understood it is not possible to recommend measures that can reduce its occurrence.

There is no appropriate treatment for crazing and so if this feature is unacceptable to the user, provision should be made at planning stage for over-painting but this will incur on-going maintenance costs.

5.7 CURLING

The process of curling is explained in Section 4.6.

Curling is quite common but generally has no practical significance and therefore often needs no action. However, floor panels sometimes curl to an extent that surface regularity is affected. Chapter 4 and Appendix C provide detailed guidance on surface regularity. Where necessary, departures from the required surface regularity can be corrected by grinding.

Curling can cause a loss of sub-base support and slab rocking and should be monitored as part of the maintenance regime and dealt with as required. Under-slab grouting can restore support.

5.8 DELAMINATION

Delamination is the process whereby a thin (2–4 mm) layer becomes detached from the surface and breaks down usually under trafficking⁽²¹⁾. The mechanisms of delamination are not fully understood but are believed to result from several factors, including differential setting of the surface concrete, air content and bleed characteristics of the concrete. Accelerated drying of the surface by cross winds from open environments can significantly affect bleeding and set characteristics.

Delamination is repaired by cutting away the affected surface in areas bounded by shallow saw cuts and then filling with cement- or resin-based mortar systems. In some cases, where the laminated surface has not been disturbed, it may be possible to repair small areas by injecting a low viscosity epoxy resin into the interface.

5.9 SLIP RESISTANCE

The slip resistance of a power-finished floor surface depends on four factors: the floor surface, the footwear worn by people, the tyres on the materials handling equipment, and the presence of surface contaminants. In many industrial situations, contaminants may be the most important factor. The designer should therefore establish at an early stage what contaminants are likely to be present during the normal operation of the premises, as this may dictate the floor finish required.

As a rule, clean, dry concrete floors are reasonably slip resistant with most but not all shoe and tyre materials. However, in practice concrete floors are not always clean and dry. Three main types of surface contaminants must be considered:

- **Dusts.** These are divided into 'soft' and 'hard' dusts. The soft type, such as talc, flour and cement dust, form a thin layer on both the concrete and the shoe sole which modifies the frictional performance of the two, potentially reducing the slip resistance. The hard type of dust, usually of much larger grain size, can act like ball bearings, particularly if the grains are rounded rather than angular, again potentially reducing slip resistance.
- **Coatings.** These often arise from the use of sprays, for example release agents that are used in factories. They can also be polishes, oils or paints; those containing silicones are particularly problematical in respect of slip resistance, and they can affect a wide area around where they are used. Their action modifies the concrete surface and may reduce slip resistance to an unacceptable level.
- **Liquids.** These form a very thin lubricating film between the shoe sole and the concrete. This occurs most with free-flowing liquids, and the lower their viscosity the more likely they are to cause a slip, and the rougher the surface needs to be to overcome the problem. Water is a common cause of slipping accidents on smooth concrete floors, particularly those that have been well trowelled to produce abrasion resistance.

To combat the effects of the various surface contaminants a degree of roughness must be provided in the concrete floor. How this is achieved will depend on the type of floor, the wear characteristics required, etc. In some instances only a light texture is needed, for example, a peak to trough roughness, R_z , of 10 μm ⁽²²⁾. However, under continued pedestrian use, surfaces with such low roughness can become polished and lose their original slip resistance.

Because applying a texture almost inevitably affects the wear characteristics, an alternative solution is for the user to adopt more appropriate housekeeping methods in order to reduce or eliminate the contaminant problem or confine it to a defined area of the floor where special precautions can be taken.

It is sometimes possible to overcome slip problems by the use of special footwear designed to provide high slip resistance in difficult situations. It should be recognised that this does not include normal 'safety' footwear, which may not give significant slip resistance benefit. While most footwear is satisfactory on concrete surfaces that are clean and dry, some materials have very low values of slip resistance.

In order to confirm the slip resistance of the floor, tests should be carried out using an appropriate test method. The pendulum described in BS 8204-2⁽¹⁰⁾ is the only machine that replicates liquid contamination and which also gives credible results in dry conditions. The procedure for use of the pendulum and the criteria for assessing the results are given in BS 8204-2. The 'Tortus' machine and other 'sled' type instruments can be used but only in dry conditions.

The commonly used process of power finishing, which produces good abrasion resistance, also tends to create lower slip resistance. Where slip resistance is of great importance, consideration may be given to further surface treatment. This could be shot blasting, acid etching or the application of resin-bound aggregate finishes. This latter method is particularly useful in areas adjacent to entrances where floors can become wetted by rain or water on incoming vehicles.

5.10 SURFACE AGGREGATE

Occasionally, aggregate particles lie exposed at or are very close to the surface. If they are well 'locked into' the surface, they are unlikely to affect durability although their appearance may be considered an issue. However, particles can be dislodged by materials handling equipment or other actions, leaving small surface voids. These voids can be drilled out and filled with resin mortar⁽²³⁾.

Where soft particles, such as naturally occurring mudstone or lignite, are exposed in the surface, they should be removed by drilling and replaced with mortar as described above.

5.11 SURFACE FIBRES

Steel fibres may be exposed at the concrete surface, depending on the fibre type, concrete mix proportions, mixing and floor finishing techniques. Their incidence can be significantly re-

duced by the use of a dry shake finish. Fibres that affect serviceability can be 'snipped off' when the concrete has hardened.

5.12 SURFACE FINISH MARKS

Trowel marks such as 'swirls' or discolouration from bur-nishing are often a consequence of the normal variations in

setting of the concrete or occasionally from poor finishing, such as over-trowelling. Usually the visual impact of these marks reduces significantly with time.

Excess curing compound or multiple layers of curing compound cause darker areas. These wear and disappear with time and use of the floor without adverse effect on the surface. See also Section 12.5.

PART TWO

DESIGN ASPECTS

This Part deals with the detailed process of designing concrete industrial floors, and will be of particular interest to engineers and contractors with responsibility for planning, design and construction.

The integrity of the layers below a ground-supported slab is of vital importance to the long-term bearing capacity and serviceability of the slab and Chapter 6 provides advice on subgrades and sub-base construction.

Chapter 7 introduces the various reinforcing systems that are used in concrete floors, and explains the principles on which they are based.

For floors to perform successfully in the long term, the joints must be planned and constructed taking full account of the loads and actions to which they will be subjected. Chapter 8 therefore provides detailed advice on the available types of joint, and their selection for different floor situations.

Chapter 9 provides comprehensive guidance on designing the floor slab for the structural and serviceability demands that will be made on it.

CONTENTS	
6	SOILS, SUB-BASES AND MEMBRANES
6.1	Introduction
6.2	Design models for soils
6.3	Subgrades
6.4	Sub-bases Racking
6.5	Membranes
7	REINFORCEMENT
7.1	Introduction
7.2	Steel reinforcement bar
7.3	Steel fabric
7.4	Steel fibres
7.5	Synthetic structural fibres
7.6	Reinforcement spacers and chairs Fork-lift truck
8	JOINTS
8.1	Introduction
8.2	Joint types
8.3	Free-movement joints
8.4	Restrained-movement joints
8.5	Tied joints
8.6	Isolation details
8.7	Performance of sawn and formed joints
8.8	Load-transfer mechanisms
8.9	Armouring of joints
8.10	Joint layout
8.11	Joints in cold stores
8.12	Joint sealants
9	STRENGTH AND SERVICEABILITY OF SLABS
9.1	Introduction
9.2	Units
9.3	Design principles and criteria
9.4	Material properties
9.5	Actions (loads)
9.6	Partial safety factors
9.7	Yield line theory
9.8	Design moment capacities
9.9	Design equations
9.10	Calculation of load transfer
9.11	Punching shear
9.12	Checks for serviceability

Licensed copy: atkins, Atkins Plc, 29/02/2008, Uncontrolled Copy, ©The Concrete Society

6 SOILS, SUB-BASES AND MEMBRANES

6.1 INTRODUCTION

The structural integrity of the layers beneath a ground-supported slab is of vital importance to the long-term bearing capacity and serviceability of the slab. This chapter provides information on:

- rationale for assessing the load-bearing capacity of sub-grades
- soil investigations
- subgrade treatment
- sub-base construction
- membranes.

Soils (geotechnical) engineering is a specialist field and readers should take appropriate specialist advice where necessary. Ground-supported floor slabs have many similarities with concrete roads. Therefore, the principal reference used for groundwork preparation is the Highways Agency *Manual of contract documents for highway works*, Volume 1, *Specification for highway works*, Series 600⁽²⁴⁾ and 800⁽²⁵⁾.

6.2 DESIGN MODELS FOR SOILS

6.2.1 Introduction

There are two models of behaviour of soils, which may be taken as representing soils under load:

- 'Winkler' model of a plate supported by a dense liquid in which a foundation is assumed to deflect under an applied vertical force in direct proportion to that force, without transmitting shear to adjacent areas of the foundation not under the loaded area
- 'elastic solid' model in which it is assumed that a vertical force applied to the surface of the foundation produces a continuous and infinite deflection basin.

The response of real soils lies between these two extremes but, traditionally, the Winkler model has been preferred for slab-on-ground design. One important difference between the two models is that, if a load is applied to a corner or an edge of a slab without any load transfer across the joint to an adjacent slab then, in the Winkler model, the loaded slab deflects with respect to the unloaded slab, and in the elastic solid model the two slabs deflect together.

6.2.2 The Winkler model

In his design concept, Westergaard^(26, 27) assumed that a slab acts as a homogeneous, isotropic elastic solid in equilibrium and that the reactions from the subgrade are vertical only and are proportional to the deflections of the slab.

The subgrade is assumed to be an elastic medium whose elasticity can be characterised by the force that, distributed over unit area, will give a deflection equal to unity. Westergaard termed this soil characteristic the 'modulus of subgrade reaction', k , that is, the load per unit area causing unit deflection, with the units N/mm^3 . The modulus of subgrade reaction is sometimes referred to as a resilience modulus and, in simple terms, the subgrade may be considered to act as if it were rows of closely spaced but independent elastic springs. Thus, the modulus of subgrade reaction is equivalent to a spring constant and is a measure of the stiffness of the subgrade.

A detailed discussion of k values is given in the comprehensive 1995 NCHRP Report 372, *Support under Portland cement concrete pavements*⁽²⁸⁾. The report makes the important recommendation that the elastic k value measured on the subgrade is the appropriate input for design.

NCHRP Report 372 confirms that the k value has only a minor effect on slab thickness design for flexural stresses and does not, therefore, need to be estimated with great accuracy. The results in Table 6.1 are taken from Report 372 and show that errors up to a value of 50% have a relatively small effect on slab thickness design. However, deflections are more sensitive to k values. See Section 9.12.

Table 6.1: Error in slab thickness design resulting from error in estimation of modulus of subgrade reaction, k . (From NCHRP Report 372).

Error in k value, %	Typical maximum error in slab thickness, %
10	1
25	2.5
50	5

6.3 SUBGRADES

6.3.1 Design considerations

Materials at deeper levels below the ground surface have their most significant effect on the long-term settlement of the slab. For a loaded floor, the bulb of pressure under loads will extend its influence to a depth well into, and possibly beyond, the subgrade or filled areas. There is therefore the potential for long-term settlements to be much larger than the elastic deflections calculated as part of the slab design. This effect could result in differential settlement between heavily and lightly loaded areas, with a consequent effect on floor surface regularity.

Materials closer to the ground surface have more effect on the measured subgrade properties than those at larger depths. The near-to-surface property of the subgrade that is used in the thickness design of a slab is the modulus of subgrade reaction, k .

Elastic k values do not reflect long-term settlements due to soil consolidation under loading. However, low values of k are indicative of plastic behaviour of the near-to-surface soils. Checks should be made on the likely deformation of the subgrade, particularly for soils with low k values.

To estimate long-term or differential settlements a geotechnical engineer should be consulted with regard to appropriate site investigation, soil testing and interpretation.

6.3.2 Soil surveys

A soil survey must address the above design considerations and a geotechnical engineer should interpret the results. The responsibility for the scope, commissioning and execution of the soil survey should be clearly established.

Information on site investigations and methods of testing soils are given in BS 5930, *Code of practice for site investigations* ⁽²⁹⁾, and BS 1377, *Methods of test for soils for civil engineering purposes* ⁽³⁰⁾.

For floor construction, it is strongly recommended that values of k are determined from a plate-loading test. Larger plates give greater accuracy and it is preferable to use a plate of the British Standard diameter of 750 mm. If other loading plate diameters are used it is necessary to employ a conversion factor, as shown in Figure 6.1. The minimum size plate used should be 300 mm. Values of k should be read at a fixed settlement of 1.25 mm.

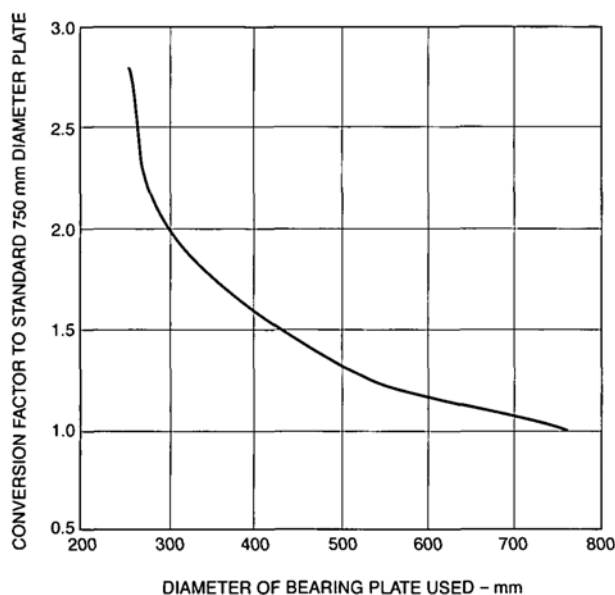

Figure 6.1: Conversion factors for different loading plate sizes.

Note: The k value obtained with the plate used should be divided by the appropriate conversion factor on the y-axis.

California Bearing Ratio (CBR) tests are sometimes used to assess soils performance although the results are less representative of long-term potential soils performance. Figure 6.2 shows the approximate relationship between CBR and k values. The CBR is the ratio of resistance to penetration developed by a subgrade soil to that developed by a specimen of standard crushed rock. The test was developed as a laboratory test, but where used, determinations of CBR should be carried out in situ.

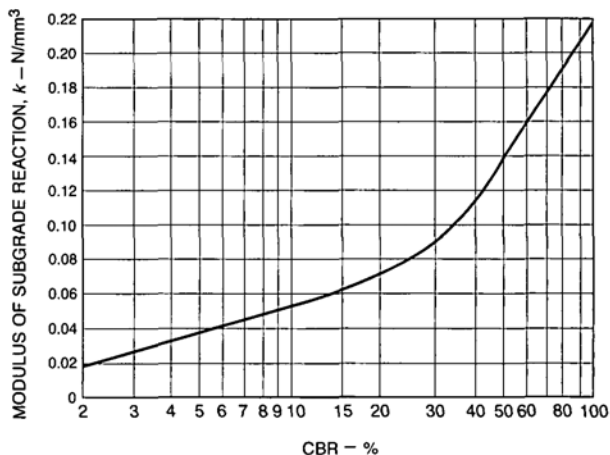

Figure 6.2: Relationship between modulus of subgrade reaction and in situ CBR.

In some cases, reliance will be placed on a soil-type assessment of k . Table 6.2 gives an indication of typical values of k related to soil type.

6.3.3 Subgrade construction

Subgrades may be either natural ground or some form of fill. They should provide uniform support and so hard and soft spots should be removed; the excavated material should be replaced with material placed and compacted to achieve properties as nearly as possible conforming to the surrounding soil.

Table 6.2: Typical values of modulus of subgrade reaction k related to soil type.

Soil type	k value (N/mm ³)	
	Lower value	Upper value
Fine or slightly compacted sand	0.015	0.03
Well compacted sand	0.05	0.10
Very well compacted sand	0.10	0.15
Loam or clay (moist)	0.03	0.06
Loam or clay (dry)	0.08	0.10
Clay with sand	0.08	0.10
Crushed stone with sand	0.10	0.15
Coarse crushed stone	0.20	0.25
Well compacted crushed stone	0.20	0.30

Note: Cold store construction must take into account both the subgrade conditions and the compressibility of the insulant layer ⁽¹¹⁾.

6.3.4 Imported fill and ground improvement

Imported fill may be used either to replace unsuitable materials or to raise the level of the subgrade above the natural ground. Fill material must be stable and its grading and moisture content such that it can be well compacted. Suitable fill materials and compaction plant and procedures are detailed in the *Specification for highway works* Series 600⁽²⁴⁾ and 800⁽²⁵⁾.

Where it is considered that special ground improvement measures may be required the advice of a specialist geotechnical or structural engineer should be sought. If construction on contaminated or polluted sites is being considered or where the presence of notifiable wastes is suspected, specialist advice should be sought. Where construction workers may come in contact with toxic wastes appropriate precautions should be taken.

6.4 SUB-BASES

6.4.1 General

The sub-base often represents a critical interface between separate contractual responsibilities, which should therefore be clearly identified, particularly in relation to the tolerances of the finished sub-base and its integrity. It will also be commercially beneficial to all parties if required concrete volumes can be assessed with minimum risk at estimating stages.

A sub-base has three main purposes:

- to provide a working platform for construction activity, which will not rut under construction traffic, see Figure 6.3
- to provide a level formation for the construction of the floor slab
- to transmit the load from the floor slab to the subgrade.

Sub-bases are usually constructed from stable, well graded granular Type 1 or Type 2 material complying with, and laid in accordance with, the *Highways Agency Specification for*



Figure 6.3: Proof loading of sub-base for construction traffic with concrete truck.

highways works, Series 800, *Road pavements – unbound materials*⁽²⁵⁾. Sub-base material Type 1 is preferred. Cement-stabilised sub-bases in accordance with the *Highways Agency Specification for highways works*, Series 1000, *Road pavements – concrete and cement bound materials*⁽³¹⁾ are also occasionally used.

Where other types of sub-base are used, such as cement-bound materials, then if advantage is to be taken in respect of load-carrying capacity of the floor, an alternative form of analysis is required that is beyond the scope of the guidance in this report.

If granular material is used, the sub-base should have a minimum thickness of 150 mm. Provided it can be shown that the sub-base material will not be subjected to freezing conditions, there is no requirement for materials in sub-bases for internal slabs to be frost-resistant. This also applies to cold stores where the sub-base is protected from frost by an insulation layer and heater mats. It should also be noted that the insulant is placed onto a base slab.

Where a soils survey has shown the subgrade to be adequate to provide support directly to the slab (e.g. a granular material with k more than 0.1 N/mm^3) it may be appropriate to lay the slab directly on the subgrade. However, the effects of plant movement and weather conditions must be taken into account when considering the omission of a sub-base.

Checks should be made to ensure that sub-base materials do not produce deleterious products likely to attack the concrete slab chemically nor expand or contract excessively with moisture movement.

Of particular importance is the recommendation in the *Highways Agency Specification for highway works*:

“The surface of the sub-base should be well closed and free from movement under compaction plant and from ridges, cracks, loose material, potholes, ruts or other defects.”

Any trimming of the surface should leave the sub-base homogenous and well compacted. Trimming layers cannot make up for deficiencies in the sub-base construction. A sand blinding layer should not be used. Sand may be used for closing the surface of coarser grained materials but any residual layer of sand at the surface should not be more than 5 mm thick.

Research⁽²⁸⁾ has shown that a compacted granular sub-base only marginally enhances the ability of the subgrade to support the concrete slab and its loads. Any enhancement of the modulus of subgrade reaction produced by a compacted granular sub-base is so small that, compared with the variations in properties that will occur in a natural soil, it should be neglected in the design process. The modulus of subgrade reaction should always, therefore, be measured on the subgrade. However, this does not remove the need for good sub-base construction practice.

6.4.2 Sub-base top surface tolerance

It is essential to minimise the risk that the slab top level and sub-base top surface are both out of tolerance at the same

point and in the adverse direction as this may reduce the thickness of the concrete slab so much that its load-carrying capacity is reduced to an unacceptable extent ⁽³²⁾. Therefore, the finished surface of the sub-base should be within +0 to -25 mm of the datum for the bottom of the slab in accordance with BS 8204-2 ⁽¹⁰⁾. Construction of the sub-base to tighter tolerances should be encouraged as this reduces wastage and provides a flatter sub-base. Positive tolerances above zero datum should not be permitted as these will directly effect the thickness of the slab. Sub-base finished levels should be surveyed at an appropriate number of points. It will be beneficial if these survey points coincide with a planned grid of survey points for the top level of the slab, to verify the actual slab thickness.

6.5 MEMBRANES

The main purpose of a slip membrane is to reduce the friction between the slab and the sub-base. Membranes are normally

1200-gauge plastic sheets in accordance with appropriate BBA (British Board of Agrément) certification or to PIFA (Packaging and Industrial Films Association) standards complying with Building Regulations. Slip membranes do not compensate for abrupt variations in level of the sub-base, see Section 6.4.

It is important to lay the membrane without creases, and overlapped at the edges by at least 300 mm, and to ensure that it is not damaged during the construction process.

The plastic sheet will inhibit the loss of water and fines from the concrete to the sub-base and can, where required, act as a water-vapour-resistant membrane. However, in some circumstances, a polythene slip membrane may not provide sufficient resistance to water vapour, see CP 102 ⁽³³⁾ and BS 8103 ⁽³⁴⁾.

Gas membranes and venting systems have become common as more construction is carried out on contaminated land. Guidance can be found in CIRIA Report 149 ⁽³⁵⁾.

7 REINFORCEMENT

7.1 INTRODUCTION

This Chapter describes the types and purpose of reinforcement commonly used in floors:

- steel reinforcement bar
- steel fabric
- steel fibres
- structural synthetic fibres.

Reinforcement spacers and chairs are also mentioned.

7.2 STEEL REINFORCEMENT BAR

Steel reinforcement bar is not commonly used in ground-supported floors although welded steel fabric is, see Section 7.3. Where bars are used, for example, to increase localised load capacity or in some pile-supported slabs (see Appendix D), structural design, and reinforcement placing and fixing should be in accordance with BS 8110 ⁽¹⁵⁾ or the draft Eurocode 2 ⁽¹⁶⁾.

Bar reinforcement should meet the requirements of BS 4449 ⁽³⁶⁾ (due to be replaced by BS EN 10080 ⁽³⁷⁾). Bars are delivered to site in stock lengths of 12 m, in scheduled lengths or cut and bent to the above standards. Bars should be bent on site only with bending equipment suitable to give the shapes required by BS 8666 ⁽³⁸⁾. Re-bending of bars after casting of concrete is permissible with mild steel bars with a yield strength not greater than 250 N/mm², and provided the radius of the bend is not less than that specified in BS 8666.

Reinforcing steel should be obtained from a supplier registered under an accredited quality assurance scheme, such as that operated by CARES, the UK Certification Authority for Reinforcing Steels.

If wire-guided vehicles are to operate on the floor, reinforcement must be fixed deep enough to avoid interference with control signals, typically 75 mm for bars of 16 mm diameter or more.

7.3 STEEL FABRIC

Steel fabric (commonly though incorrectly referred to as 'mesh') should be to BS 4483 ⁽³⁹⁾. 'A' type fabrics are most commonly used in floors. Fabric should be obtained from a supplier registered under an accredited quality assurance scheme such as that operated by CARES, the UK Certification Authority for Reinforcing Steels. Fabric should be free of loose rust, scale, grease and dirt.

Steel fabric is commonly used in ground-supported floors – the proportion being typically in the order of 0.1 to 0.125%. Traditionally, steel fabric was included with the intention of controlling shrinkage-induced cracking. However, at these low percentages, there is insufficient steel to affect the crack width and crack distribution significantly. Percentages in the order of 0.4% would be required to achieve the degree of control typically considered in structural codes of practice, i.e. limiting surface crack widths to about 0.3 mm. Traditionally it was also considered that, for shrinkage crack control, the fabric should be placed in the top of the slab. There are conflicting views on the most effective position for the fabric but the area of fabric used in a slab is very small and so its location is generally not critical. In small areas where restraint, aspect ratio or other factors are less than ideal, such as around dock levellers (see Figure 7.1), a top layer of fabric is often used in addition to that in the bottom.

During the 1990s, floor laying became increasingly mechanised: floors were laid in large areas and sawn into panels of about 6 × 6 m. Thermal contraction and drying shrinkage are accommodated by the cracks induced below these saw cuts. The fabric limits the opening of these induced cracks to a typical width at the top surface of 1 to 2 mm although some joints can open wider. These wider openings, known as 'dominant joints', are discussed in Section 8.10.2. If mid-panel cracks occur because of shrinkage, the fabric will provide some restraint to opening of the crack, the width at the top surface again being 1 to 2 mm.

Empirical evidence suggests that using nominal areas of fabric in large area floor construction gives satisfactory

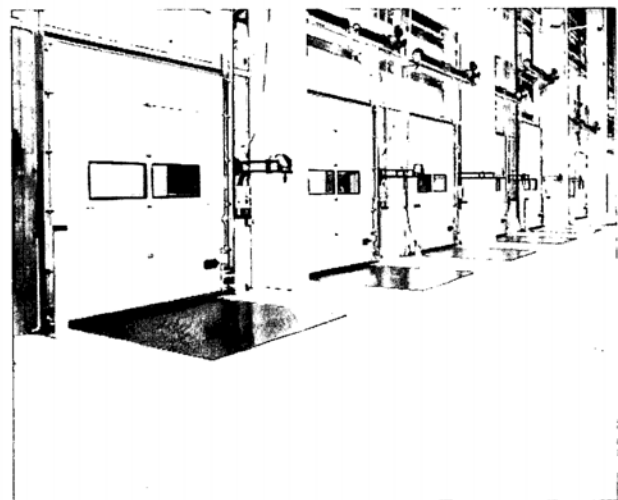

Figure 7.1: Dock levellers. Additional reinforcement may be needed in the areas around each entrance.

results in terms of shrinkage cracks, which are relatively uncommon. A similar approach has become common in long strip construction. The traditional use of B-type fabrics⁽⁵⁾, which have a greater area of steel in the longitudinal direction, has decreased; A-type fabrics, with equal areas in each direction, are increasingly used, with restrained-movement joints at 6 m intervals to form nominally 6 m-square panels, similar to large area construction. This approach is considered to result in a lower risk of cracking than using heavier fabric and more widely spaced joints.

Steel fabric has traditionally been considered to have no structural effect, that is, not to increase the load-carrying capacity of a slab. However, a Concrete Society project to evaluate the structural performance of slabs reinforced with fabric has recently been completed⁽⁶⁾. Requirements for ductility of slabs containing steel fabric have been identified, and design guidance has been developed, which is given in Appendix E. This guidance assumes that the fabric is in the bottom of the slab with typically 50 mm of cover. Fabric in the top of a slab is ignored for structural design purposes as the design criteria for ground-supported slabs dictate that load-induced cracks are not permitted in the top of the slab. Where the fabric is to be used for structural advantage, it is of vital importance that it is correctly and securely positioned in accordance with the design cover.

Fabric also has a dowelling effect and can provide load transfer across joints, see Section 8.8.5 and 9.10. Care should be taken when considering increasing fabric areas to enhance load-transfer capacity as this could limit the ability of sawn joints to open, resulting in mid-panel cracking, see Section 8.10.2.

Where the fabric is used for structural purposes, continuity of fabric is of particular importance. However, sawn restrained-movement joints should not be positioned over multiple layers of fabric as the increased restraint may limit the opening of the joint.

If wire-guided vehicles are to operate on the floor, fabric must be positioned deep enough to avoid interference with control signals, typically 50 mm for A142 fabric. As stated above, fabric will normally be placed towards the bottom of the slab.

7.4 STEEL FIBRES

Steel fibres are commonly used in concrete to provide structural (load-bearing) capacity and for the control of shrinkage-induced cracking. It should be stressed, however, that fibres do not influence flexural tensile strength, as defined by the load capacity at first crack. See Figure 7.2.

Steel fibres for reinforcing concrete are manufactured from cold-drawn wire, steel sheet and other forms of steel. Wire fibres are the most common type used in floors. They vary in length up to about 60 mm, with aspect ratios (ratio of length to nominal diameter) from 20 to 100, and with a variety of cross-sections. In order to gain pull-out resistance fibres have enlarged, flattened or hooked ends, roughened surface textures or wavy profiles.

The resultant composite concrete can have considerable ductility, often termed 'toughness'. The ductility characteristic is dependent on fibre type, dosage, tensile strength and anchorage mechanism. This ductility is utilised in the floor thickness design. See Section 9.8. The measurement of post-first-crack flexural strength is taken into account in the calculation of design positive (sagging) moment capacities. The effect of the fibres is ignored in respect of negative (hogging) moment capacity as the design criteria for ground-supported slabs dictate that load-induced cracks should not be permitted in the top of the slab. Information on incorporating steel fibres into concrete can be found in Section 11.5.

Ductility is commonly measured using the Japanese Standard test method JSCE-SF4⁽⁴⁰⁾, which uses beams in a third-point loading arrangement. Load-deflection curves are generated, as shown in Figure 7.2. The $R_{e,3}$ value, a measure of the ductility, is the average load applied as the beam deflects to 3 mm expressed as a ratio of the load to first crack. This measure is also commonly known as the equivalent flexural strength. There are no relevant UK standards for steel fibres.

For the purposes of design in Chapter 9, it is assumed that, as is the case with the other materials such as concrete and steel reinforcement, the $R_{e,3}$ values for steel fibres are characteristic values.

In 'jointless' slab construction (see Section 2.2.2), steel fibres at dosages in the order of 35–45 kg/m³ are used to control the width and distribution of shrinkage-induced cracks. In floors with sawn joints, dosages in the range 20–30 kg/m³ are typical. Manufacturers should be asked for data to demonstrate that dosages at the lower end of this range are effective as there is a lower limit below which a continuity of fibres in the concrete cannot be guaranteed. It is also necessary to demonstrate minimum ductility for steel fibre concrete to be used in the limit state designs used in the report, see Section 9.4.2.

Steel fibres that are well distributed in concrete have no effect on wire guidance systems but agglomerations of fibres may affect such systems, see Section 11.5.

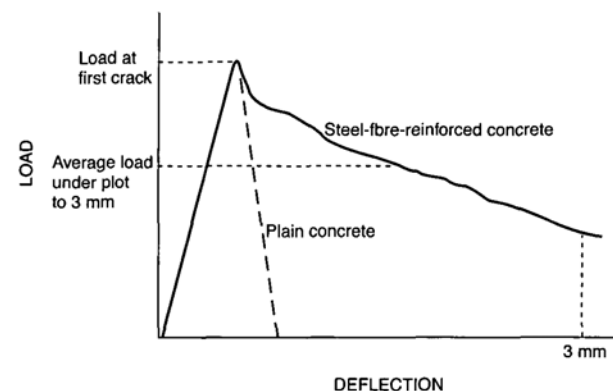

Figure 7.2: Typical load-deflection graph for steel-fibre-reinforced concrete beams.

7.5 STRUCTURAL SYNTHETIC FIBRES

It is necessary to distinguish between the short polypropylene 'micro' fibres and the larger synthetic fibres being developed for structural benefits similar to steel fibres.

Polypropylene micro fibres used at typical dosages of 0.9 kg/m³ do not provide any significant post-first-crack ductility, as defined and measured by Japanese Standard test method JSCE-SF4⁽⁴⁰⁾. Therefore they do not fulfil any structural role, as would steel fibres with proven structural performance.

Structural synthetic fibres are larger and used at significantly higher dosages than polypropylene microfibrils. (See Section 11.6.) As with steel fibres, data should be available to

demonstrate the performance of synthetic structural fibres in practice (see Section 9.4.3).

7.6 REINFORCEMENT SPACERS AND CHAIRS

It is important that reinforcement is securely located in the position required by the designer or its effectiveness may be severely reduced. Chairs for supporting reinforcement are manufactured from concrete, plastic or steel. Chairs suitable for ground-supported slabs are designed to prevent puncturing of the membrane or sinking into the sub-base. Spacers and chairs and their use should be in accordance with BS 7973-1 and BS 7973-2⁽⁴¹⁾.

8 JOINTS

8.1 INTRODUCTION

Joints are unavoidable elements in all concrete floors and their design and construction require careful attention because they can be a significant potential source of problems. The edges of slab panels are vulnerable to damage caused by the passage of materials handling equipment, with wider joints being more susceptible. The small hard wheels on pallet trucks and similar trucks are particularly aggressive.

The number and type of joints in a floor will depend on the floor construction method and its design. The method chosen should be related to the planned use of the floor and other factors. For example, long strip construction may have to be used where a very flat floor is required. See also Chapter 2.

Joints are provided for two reasons:

- to relieve tensile stresses induced by drying shrinkage or temperature changes
- to cater for breaks in the construction process.

Joints in concrete floors are created in two ways:

- sawing
- forming, with formwork.

Plastic crack inducers pushed down into the wet concrete can also be used to induce joints. However, this method is not recommended as they create poorly defined arrises and have an adverse effect on surface regularity. They also make finishing difficult. In this report, induced joints are assumed to be sawn and are referred to as sawn joints.

Sawn and formed joints can perform differently. In most cases, sawn joints are more durable and have less effect on materials handling equipment for a given joint width. All aspects of the performance – in terms of load-transfer capacity, deflection and durability – decrease as they become wider. Armouring with steel sections can enhance the performance of formed joints; see Section 8.9. Performance of sawn and formed joints is covered in Section 8.7.

Specific requirements are discussed in Section 8.3 with additional information for pile-supported slabs in Appendix D.

8.2 JOINT TYPES

Joints are sometimes described in ways that may cause confusion, with terms being used loosely for more than one type of joint. For example, the terms 'day joint' and 'construction joint' are both used for joints that may be free-movement, restrained-movement or tied joints, the only common feature

being that formwork is used in their construction. To avoid confusion and to encourage the use of a consistent terminology, it is recommended that joints are classified according to the movement they allow and the method by which they are formed, as follows:

- free-movement joints
 - sawn
 - formed
- restrained-movement joints
 - sawn
 - formed
- tied joints
- isolation details.

8.3 FREE-MOVEMENT JOINTS

8.3.1 Purpose

Free-movement joints are designed to provide a minimum of restraint to horizontal movements caused by drying shrinkage and temperature changes in the slab, while restricting relative vertical movement. There is no reinforcement across the joint. Dowels or other mechanisms provide load transfer. Load-transfer mechanisms including dowels and dowel sleeves should be engineered to minimise vertical movement, see Section 8.8.

A free-movement joint (not an isolation detail) should be provided between a floor slab and an adjoining structure where the adjoining structure, for example a conveyor tunnel or dock leveller (Figure 7.1), forms part of the floor surface trafficked by MHE.

Free-movement joints can be sawn or formed. They have the potential to open wider than restrained-movement joints.

8.3.2 Sawn free-movement joints

Sawn free-movement joints are cut as soon as the concrete is strong enough to be cut without damaging the arrises, see Figure 8.1. For more detail on sawing joints see Section 8.7.



Figure 8.1: Sawn free-movement joint

De-bonded dowels set in position in dowel cages before the concrete is placed provide load transfer. Steel fabric does not cross the joint. Care must be taken to ensure that the dowels are horizontal and perpendicular to the line of the joint and that their positions are not disturbed during the placing of the concrete. If this is not done, the joint will become tied, thereby increasing the risk of a crack forming nearby or a larger opening of an adjacent restrained-movement joint – a dominant joint.

8.3.3 Formed free-movement joints

Formed free-movement joints are created by formwork and are usually provided to coincide with a planned concrete pour or to maintain an acceptable aspect ratio of the floor panel. De-bonded dowels, plate dowel systems or steel tongue-and-groove systems provide load transfer. Typical examples are shown in Figure 8.2.

Dowels can be round or square. The sleeves of square dowels have foam side inserts (or similar compressible features) to allow lateral as well as longitudinal movement. Sleeves should be of a shape compatible with the bar and with a good fit and sufficient stiffness to prevent vertical movement.

Plate systems can be continuous or of individual elements of various shapes to allow lateral movement. These can be incorporated into permanent formwork systems, which provide steel faces to the arrises. For more information on load transfer and arris protection see Sections 8.8 and 8.9.

8.3.4 Wire guidance systems

Where wire guidance is to be installed across free-movement joints, in particular in jointless construction, the wire needs to have ‘slack’ to accommodate the movement. This may be achieved by providing a loop between the joint faces.

8.3.5 Expansion joints

Expansion joints are not normally used in internal floors, except those subject to above-ambient temperatures and to large temperature fluctuations. In most floors, the dominant movement is that caused by drying shrinkage and any on-going thermal related movements are much smaller. Cold store floors have greater thermal movements but the slabs do not expand beyond their as-constructed dimensions. Therefore expansion joints are not required. Designers should satisfy themselves that there is a definite need for expansion joints, avoiding their unnecessary installation and the resulting wide gap required between floor panels. Expansion joints require the provision of load transfer by de-bonded dowels or other mechanisms, see Section 8.8.

8.4 RESTRAINED-MOVEMENT JOINTS

8.4.1 Purpose

Restrained-movement joints are provided to allow limited movement to relieve shrinkage-induced stresses at pre-

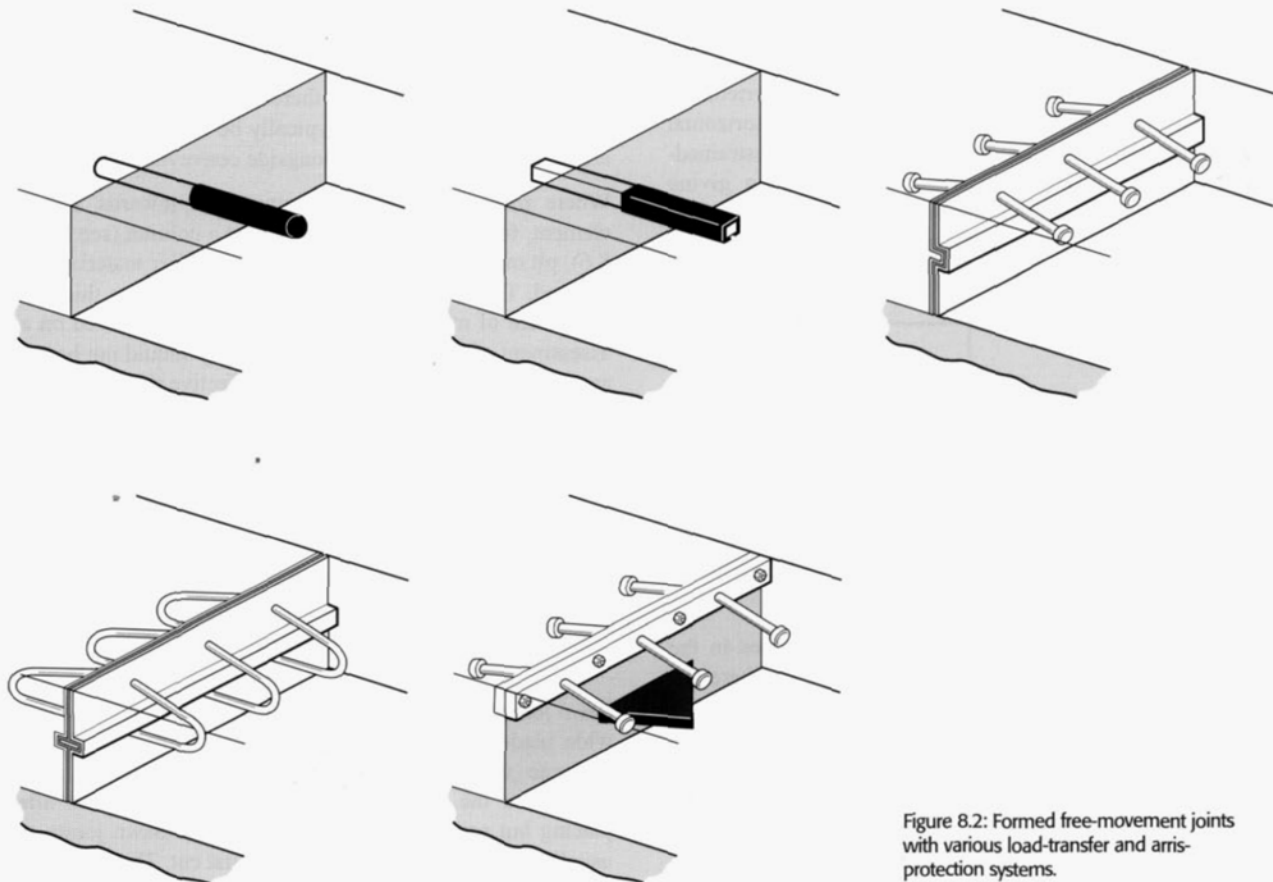

Figure 8.2: Formed free-movement joints with various load-transfer and arris-protection systems.

determined positions. Reinforcement is assumed to be continuous across the joint.

8.4.2 Sawn restrained-movement joints

Sawn restrained-movement joints are sawn as soon as the concrete is strong enough to be cut without damaging the arrises, see Figure 8.3. For more detail on sawing joints see Section 8.7.

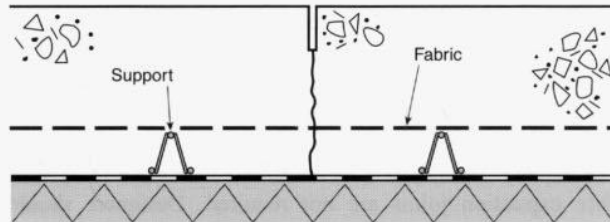

Figure 8.3: Sawn restrained-movement joint (shown with fabric).

For slabs cut into (typically) 6 m panels, these joints can be expected to open by an extra 1–2 mm beyond their initial width at the top surface of 4–5 mm as the reinforcement across the joint yields under the stresses created by the shrinkage of the concrete.

Load transfer is provided by reinforcement across the joint or by aggregate interlock, see Section 8.8. Care should be taken if considering increasing fabric areas in order to enhance load-transfer capacity as mid-panel cracking could occur, see Section 8.10.2.

8.4.3 Formed restrained-movement joints

Formed restrained-movement joints are created by using formwork through which reinforcing bars are inserted, see Figure 8.4. The joint is designed for some limited horizontal movement, similar to that expected in a sawn restrained-movement joint, the bar dimensions and spacing giving approximately equivalent cross-section per metre length of joint to that of the fabric in the slab. The reinforcing bars provide load transfer.

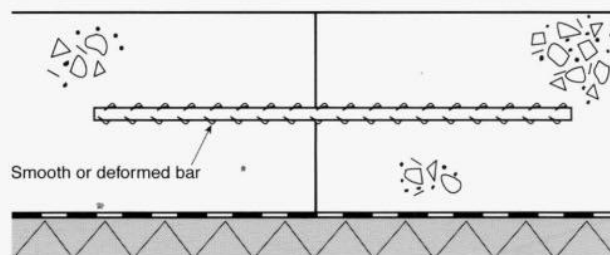

Figure 8.4: Formed restrained-movement joint.

Like other formed joints, there will be weaknesses in the arrises but the potential for damage is reduced where the arrises are in close proximity, see Section 8.7.

8.5 TIED JOINTS

Tied joints (Figure 8.5) are sometimes provided to facilitate a break in construction at a point other than at a free-

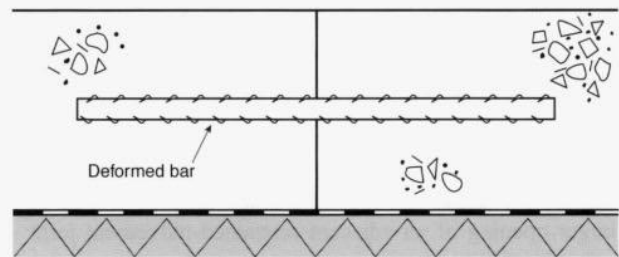

Figure 8.5: Tied joint.

movement joint. The joint is formed and provided with a cross-sectional area of steel reinforcement high enough to prevent the joint opening. That is, the load capacity of the steel used should be greater than the tensile capacity of the concrete, i.e.:

$$\frac{A_s f_y}{\gamma_s} > A_c \times f_{ctk(0.05)}$$

Eqn 8.1

(See Chapter 9 for explanations of these terms.)

The reinforcement bars also provide load transfer.

8.6 ISOLATION DETAILS

The purpose of isolation details is to avoid any restraint to the slab by fixed elements at the edges of or within the slab, such as columns, walls, machinery bases or pits. They can also be used to isolate the slab from machinery bases that are subject to vibration. However, where a floor slab adjoins a fixed structure that is itself to form part of a trafficked area over which MHE will pass then a free-movement joint should be provided so that there is adequate load transfer without restraint. This will typically be the case at dock levellers (see Figure 7.1) and alongside conveyor tunnels.

Where there is any risk of movement towards a fixed element, for example, laterally against a column (see Figure 8.6), pit or base, a flexible compressible filler material must be used. These materials are typically 10–20 mm thick and the choice of material and thickness should be based on an assessment of the likely movement. They should not be bent around right-angled corners, as the effective thickness at the corner will be much reduced by pinching.

Isolating materials should extend throughout the full depth of the slab and be sealed effectively to prevent the ingress of grout into the space between the slab and adjoining structure. Typical details are shown in Figures 8.6 and 8.7.

8.7 PERFORMANCE OF SAWN AND FORMED JOINTS

Sawn joints (Figure 8.8) are usually created by a 3 or 4 mm-wide blade made as soon as practicable after placing the concrete when the concrete is strong enough to avoid damage to the arrises. This is nominally 24 hours after placing but preferably earlier (Figure 8.9). Sawn joints are usually 4–5 mm wide when they are first cut. They are cut to



Figure 8.6: Isolation details around column.

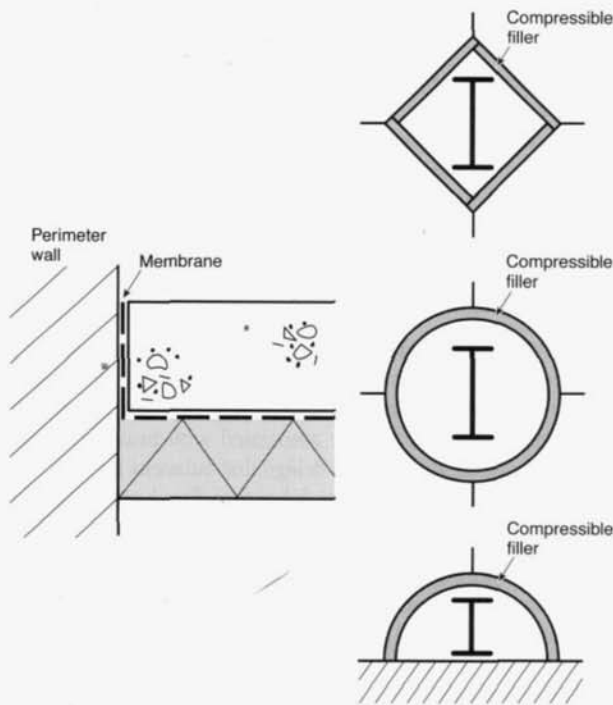

Figure 8.7: Slab isolation details at slab perimeter and columns.



Figure 8.8: Joint sawing.

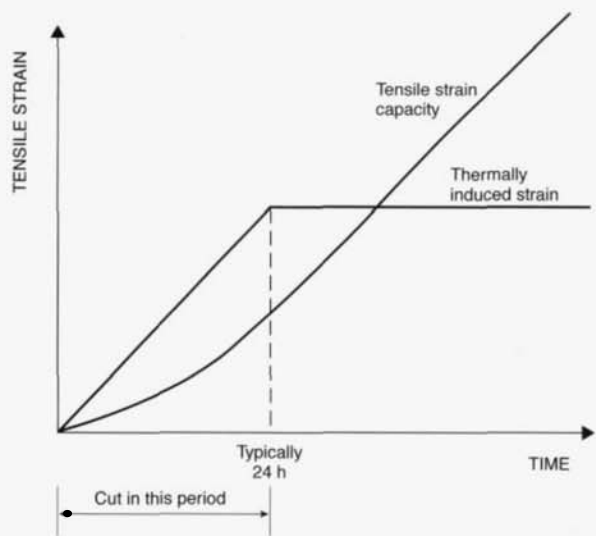

Figure 8.9: Suggested mechanism of crack inducement.

a depth of at least one-quarter of the slab depth, creating a line of weakness in the slab that induces a crack below. The depth of the cut is related to the age of the concrete at the time of cutting: deeper cutting is required with increased age. Joints cut at a very early age, soon after power finishing and using specialist cutting equipment, can require depths of as little as 10% of the slab depth.

The mechanism for the opening of sawn joints is dependent on the stress induced primarily by thermal contraction exceeding the tensile capacity of the immature concrete. Over time, the tensile capacity of the concrete increases significantly by comparison with the thermally induced stress, which reaches a plateau. This is illustrated in Figure 8.9.

It should be noted that deeper saw cuts will reduce aggregate interlock and the associated load-transfer capacity of the joint, see Section 8.8.

The concrete at the arrises of a sawn joint is representative of the slab as a whole, being fully packed with aggregate and without excess cement paste, see Figure 8.10. Sawn arrises are therefore potentially more durable than formed arrises.

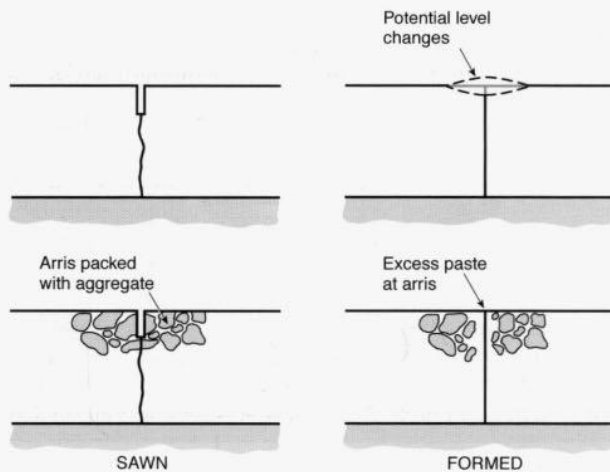

Figure 8.10: Concrete integrity and levels at sawn and formed joints.

Surface levels across a sawn joint are consistent with the profile of the floor to either side of the joint. Generally, there will be minimal interruption to wheeled traffic across sawn restrained-movement joints. However, sawn free-movement joints can be expected to have wider openings.

Formed joints are created using timber or steel formwork. The latter can be permanent, forming steel arrises at the joint, see Section 8.9. Joint formers should extend as near as possible to the full depth of the joint face and should not permit extrusion of concrete beneath their lower edges. However, a small gap is useful as it will allow air to escape and will provide visual confirmation of full compaction when concrete paste is evident at the base of the formwork.

The concrete at the arris of a formed joint will have less aggregate and more relatively weak cement paste. The concrete at the edges may be less well worked by the power trowel. Care is needed when removing temporary formwork to ensure that the arris is not damaged, see Figure 8.10.

Care is also needed to obtain the required surface regularity immediately adjacent to either side of, and therefore across, a formed joint as shown in Figure 8.10.

8.8 LOAD-TRANSFER MECHANISMS

8.8.1 Introduction

The load-carrying capacities of a slab at a free edge and at a free corner are approximately 50% and 25% of the capacity at the centre of the slab. True free edges or corners that are required to carry load are relatively unusual, as they generally occur only at the periphery of a building. Joints between panels and the intersections of these joints are of greater importance: provision must be made to transfer load across them ('load-transfer capacity'), and to prevent differential vertical movement. If load transfer across a joint is not provided or cannot be assumed, a slab will have to be designed for the free-edge/corner load cases. See Section 9.9.2.

Although the theoretical load capacity at the intersection of two joints is much lower than at a single joint, experience has shown that the actual capacity appears to be as great, given the same conditions of joint opening and provision of dowels or other load-transfer mechanisms. Therefore, in practice, potential loads at intersections are not taken into account, provided that appropriate design considerations are applied to the single joints in the floor.

Load-transfer capacity is principally dependent on:

- aggregate interlock (at sawn joints)
- the mechanism of the joint.

Sub-base support may have some influence but it is not considered in the design process in Chapter 9.

In free movement joints, the mechanism of the joint will be a significant factor.

The effectiveness of aggregate interlock and any joint mechanism is related to the width of the joint opening, and so the design of joints should take into account the planned opening after the completion of drying shrinkage and other movements. The design should also take into account the capacity of the concrete to prevent the load-transfer mechanism from bursting (punching) out of the concrete, see Section 9.10. Joint openings should be reduced by minimising the shrinkage of the concrete, see Section 10.3.2.

Joint mechanisms can consist of round or square dowels or plate dowels that are either discrete or continuous. Some of these joint designs incorporate steel protection for armouring the joint arris, see Section 8.9. Some dowel types are shown in Figure 8.2. Steel reinforcement including fabric also acts as dowels. Guidance on establishing the load-transfer capacity of dowels is given in the following sections and in Section 9.10.

The movement of materials handling equipment will cause some relative deflection across joints. Joints should be designed to reduce this to a negligible amount. As deflections increase through loss of aggregate interlock, failure of joint mechanisms to continue to provide a close fit between dowel and sleeve or loss of subgrade support, the rate of degeneration increases under dynamic loads.

8.8.2 Aggregate interlock

Assessment of the load-transfer capacity created by aggregate interlock is complex as there are many variables. However, failure of floors as a result of overloading at joints is unusual; if failure occurs it is usually associated with heavy dynamic loads. Providing guidance on design that balances the need for economy against acceptable risk has therefore been difficult.

One of the key factors in aggregate interlock is the width of the joint opening. In this regard, it has been noted that remedial works to reinstate aggregate interlock are relatively straightforward, usually involving grouting with a resin or cementitious system. However, any such intervention depends on timely action and it is important that all floors are routinely monitored and maintained.

Earlier guidance suggests that 15% load transfer can be assumed across a joint but the conditions under which this guidance applies are not clear although it appears to be assumed that the joints are dowelled in some way.

Although the degree of load transfer is primarily a function of the joint opening, it is also necessary to consider the effects of vertical movement of the joint caused by loading and unloading, as any such movement will reduce the effectiveness of the interlock over time.

Research by Colley and Humphrey⁽⁴²⁾ suggests that load transfer by aggregate interlock reduces to minimal levels as the joint opens towards and beyond 2 mm. This work studied dynamic effects from trucks and was based on site investigations and laboratory simulations. Therefore, interpretation and application of this research to ground-supported slabs requires care. However, one clear conclusion is that dynamic repetitive loads cause degeneration of the interlock mechanism particularly at wider openings.

Designers of floor slabs should therefore consider whether the loads are static or dynamic as dynamic loads are likely to have more effect on joints. Purely static loads are relatively uncommon in warehousing; for example, point loads from VNA trucks can be quite high and of a similar order to those from racking leg loads. It is also necessary to consider the width of the joint opening.

For a well-designed concrete, long-term shrinkage strains are in the range 400 to 600×10^{-6} mm. For a 6 m slab these are equivalent to an overall unrestrained shortening of 2.4 to 3.6 mm, but this will be mitigated by restraint and creep. It is estimated that joints will open by approximately half these values, that is, 1.2 to 1.8 mm. Taking into account the limits of accuracy in these estimates, of associated site measurement and the inherent variability of the joint openings in any one floor, it is suggested that the range of openings that will be found in practice is 1.5 to 2.0 mm. It is not possible to be precise and some openings will fall outside this range without necessarily causing significant loss of performance, although this will be a matter of degree.

Existing guidance based on the work of Colley and Humphrey suggests that 15% of load can be supported by the adjoining slab. This guidance is not adequately qualified in relation to joint opening. Interpretation of the original work requires caution, but it is suggested that the opening at which this level of load transfer applies is 1.5 mm. It should again be noted that this research was based on repeated dynamic loadings of heavy goods vehicle wheels over about 100,000 cycles.

For this edition of TR 34, it is suggested that, for design purposes, 15% load transfer is assumed at 1.5 mm opening. Additional load transfer capacity for dowels across sawn restrained-movement joints can be calculated by reference to Section 9.10. This includes data for steel fabric, which typically provides 10% load transfer, although the calculations are based on absolute values in shear and bending with an assumed joint opening of 2 mm.

Where dynamic loads predominate, load transfer by aggregate interlock is less certain at any width of opening because of the degenerative effects of relative vertical movement across the joint.

When assessing the performance of existing joints in floors, care should be exercised in drawing conclusions about the effect of joint openings on load transfer as, on the present level of knowledge, it is not possible to give definitive guidance.

8.8.3 Steel-fibre-reinforced concrete

In steel fibre reinforced slabs with no other load transfer mechanism, there will be some limited capacity to transfer load to adjoining panels although data to provide guidance is not available. For performance details it is recommended that the steel fibre supplier be consulted.

Research at the University of Queensland⁽⁷⁾ has demonstrated that steel fibres enhance dowel burst-out capacity. However, it appears that this performance is a function of fibre type and careful interpretation of this research is required.

8.8.4 Round and square dowels

Round or square dowel bars are commonly used to provide load transfer. A simplified treatment of the load-transfer capacity of dowels is given in Section 9.10.

8.8.5 Steel fabric reinforcement

Where it can be assumed that the use of fabric in restrained-movement joints will control joint opening to a maximum of 2 mm, load-transfer capacity of the bar will be governed by combined tension and shear resistance. At this opening the steel crossing the joint will have yielded and this condition has been taken into consideration in Table 9.7, which gives values of load-transfer capacity per linear metre for commonly used fabric sizes, based on equations in Section 9.10.

Care should be taken if considering increasing fabric areas in order to enhance load-transfer capacity as mid-panel cracking could arise. See Sections 7.3 and 8.10.2.

8.8.6 Proprietary systems

Continuous plate dowels and discrete plate dowels of trapezoidal or diamond form are available as alternatives to traditional bar dowels. Manufacturers' data on the load-transfer capacity should be consulted for use in design, related to likely joint openings.

8.9 ARMOURING OF JOINTS

8.9.1 Introduction

The arrises at formed free-movement joints can be protected by steel armouring, as shown in Figure 8.2. A number of proprietary systems are available. Most are combined with permanent formwork and load-transfer systems; some comprise strips at only the upper part of the joint faces. Performance-related issues to consider are the width, grade and flatness profile of the steel arris and the capacity of the load transfer mechanism at potentially wide openings of typically 20 mm to be found in jointless construction.

Where a load transfer mechanism is included, its design should take into account the effective depth of the concrete that surrounds it when considering bearing and burst-out capacity.

To be effective, the steel arris must be sufficiently stiff and well fixed to the concrete to resist and distribute the impact forces of the materials handling equipment wheels. Once any movement of the steel starts, the rate of degradation will increase, with both the steel arris and the concrete behind becoming damaged. A damaged armoured joint is potentially more difficult to repair than an unarmoured joint. The steel should be thick enough to resist deformation at its arris and should have a perfect right-angled profile on both the joint opening face and the face adjacent to the concrete.

Long-term performance of armoured joints can be improved by monitoring the joints over the first year or two of life and filling as required, see Sections 4.3, 8.12 and 13.5. In addition to using joint sealants, armoured joints can be fitted with welded steel strips once joint openings have stabilised. This method can be of particular use in jointless construction.

8.9.2 Anchorage fittings

Anchorage fittings such as 'tangs' or shear studs need to provide adequate stability without creating planes of weakness in the concrete close to the joint. They should extend to the full length of the joint and be provided close to the ends and near to joint intersections. In addition, consideration can be given to welding the armouring sections at corners and intersections on site or by the use of prefabricated sections. However, it is important to ensure that at intersections, all four corners are free from connection to each other. It must be possible to compact the concrete fully under and around the anchorages and any other steel sections if used for a load-transfer mechanism.

8.9.3 Ease of construction

The armouring system should be provided with a means of fixing with sufficient accuracy appropriate to the flatness classification of the floor. Matching halves of the system must have temporary locating devices to provide stability during construction and accuracy across and along the joint when in service. These devices should be removed during construction or be self-shearing. Inaccuracies are not easily remedied after construction. In some designs the armouring system functions as the formwork.

8.9.4 Shrinkage along joints

The primary purpose of free-movement joints is to provide for shrinkage. Therefore, joint armouring sections should be discontinuous at joint intersections.

8.10 JOINT LAYOUT

8.10.1 Joint spacing and detailing

In jointed floors the objective is to minimise the risks of cracks in panels. In an ideal joint layout plan this is achieved by:

- limiting the length to width ratio (the aspect ratio) of all areas between free-movement joints to 1.5
- limiting the length to width ratio (the aspect ratio) of each panel to 1.5
- limiting the longest dimension between sawn joints to typically 6 m
- avoiding re-entrant corners
- avoiding panels with acute angles at corners
- avoiding restraint to shrinkage by using isolation details around fixed points
- avoiding point loads at joints.

In practice, the floor plans of most buildings dictate that conflicting requirements have to be balanced. Columns, bases and pits do not always conveniently fit to predetermined grids and areas around dock levellers pose particular difficulties. Therefore, basic panel grids may need to be modified to accommodate column spacing and other details that depart from the ideal joint layout. Caution should be exercised if joint spacings are increased beyond 6 m, and particular attention should be paid to concrete shrinkage and sub-base preparation, in addition to the factors listed above. Joint openings will also increase as joint spacing increases.

Ideally, joints should align with each corner of fixed construction elements. Where this is not practical, it may be necessary to have an internal (re-entrant) corner in the panel. There is a risk of cracking at such corners. This can be reduced or controlled by placing additional reinforcement bars diagonally across the corner. Additional saw cuts can also be provided to confine anticipated cracking to predetermined positions.

Slabs should be isolated from fixed elements such as ground beams, dock levellers, column surrounds, slab thickenings and machine pits. Care must be taken when fixings into the slab are used to resist portal-frame kick-out forces as these fixings can cause restraint to shrinkage. This may be achieved by debonding such fixings for some distance into the slab but there will still be some risk of cracking.

In narrow aisle warehouses, longitudinal formed joints should be positioned to avoid the wheel tracks of materials handling equipment.

8.10.2 Joint spacing and reinforcement

Joints in large area construction

Floors are frequently poured with lengths and widths in the order of 50 m. These dimensions are limited by the area of concrete that can be constructed in a day. In principle, larger areas could be poured or large areas could be joined by formed restrained-movement joints or intermediate tied joints, provided that limits on distances between sawn joints and overall aspect ratios are not exceeded.

Formed free-movement joints are usually provided at the perimeter of each pour. Sawn restrained-movement joints are cut as early as possible after casting. A crack is induced

under the saw cut as a result of the thermal contraction associated with the cement hydration process, see Section 8.7.

The floor then becomes a set of smaller panels that continue to shrink as they dry out. If the sub-base has been constructed in accordance with the recommendations in Chapter 6 and has been provided with a slip membrane, the frictional restraint will be relatively low, and the panel will shrink with a low risk of cracking.

Many ground-supported floors are constructed using 'nominal' areas of steel fabric reinforcement, typically 0.1 to 0.125%. It is assumed that the reinforcement across the restrained joint yields as the panels shrink. Reducing the percentage of steel carries the risk of a dominant joint forming as any single joint is more likely to act as a free-movement joint as the steel yields. Increasing the percentage of steel carries the risk of more mid-panel cracking, as the steel may not yield at each joint.

In practice, the distance between sawn joints might be extended beyond 6 m to accommodate features of the building, but it is not possible to give detailed guidance. However, the risk of mid-panel cracking can be reduced by:

- minimising concrete shrinkage, see Section 10.3.2
- minimising sub-base restraint. Sub-base friction is now thought to be much lower than previously believed⁽⁸⁾. However, restraint can still be a significant factor on uneven or rutted sub-bases
- limiting the aspect ratio of the panel to 1.5.

Joints in long strip construction

The long strip method of construction results in a higher proportion of formed joints although these may be of a 'leave-in-place' format, which give better joint arris formation and protection. Alternate strips or adjacent strips are laid continuously for the full length of the floor, or up to a formed free-movement joint. Subsequent strips are placed when the adjacent concrete is strong enough to avoid damage.

The strips are divided into panels by means of sawn restrained-movement joints.

Decisions about reinforcement areas and joint spacing are the same as for large area construction. Longitudinal joints between strips are formed restrained-movement joints and incorporate tie bars that provide a similar area of steel per linear metre to that of the fabric in the strips. It follows that B-type fabrics are unlikely to be used.

Formed free-movement joints are provided at intervals similar to those in large area jointed construction, see Section 2.2.1.

Dominant and dormant joints

Sawn restrained-movement joints in large area pours may not all move by the same amount. This is generally not a problem, but in some cases 'dominant joints' can form. In these cases, movement from several panels is concentrated at one joint rather than being spread over a number of joints. Joints that fail to open are known as 'dormant joints'.

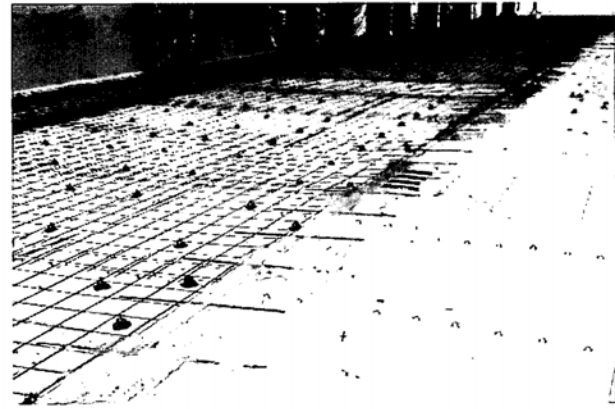

Figure 8.11: Permanent formwork, with dowel bars in place, for a formed restrained-movement joint in a long strip construction. The walls and columns are protected with polythene.

The mechanisms are not fully understood but the timing of cutting of joints appears to be a factor. It is suggested that if joints are cut early enough, then thermally induced contraction will be more likely to create sufficient stress to crack the immature concrete beneath all of the saw cuts. Dominant joints can also be caused by the locking up of adjacent sawn free-movement joints, sub-base rutting and by restraints to movement caused by early loading of the slab.

As the incidence of dominant joints cannot be entirely eliminated, designers should be aware of the possibility of loss of load-transfer capability at sawn restrained-movement joints. Any loss of load-transfer capability is likely to become apparent over time because of trafficking. Joints should therefore be monitored in use and consideration given to early remedial works.

8.10.3 Jointless construction

'Jointless' construction in this context means construction without sawn restrained-movement joints. Floors are poured in areas of up to 50 m in each direction. Formed free-movement joints are provided at the perimeter of each pour. This method of construction is currently associated with the use of steel-fibre-reinforced concrete. In principle, fabric reinforcement could be used but there is little experience of this and it is likely that the percentage area of steel provided would need to be similar to that used in continuously reinforced concrete road construction, that is, 0.4–0.6% in both directions.

The philosophy is that shrinkage cracks will be well distributed and limited to widths that will not affect serviceability. The joints will open up to 20 mm.

8.11 JOINTS IN COLD STORES

Cold store slabs are subject to significant temperature-related strains. Sawn restrained-movement joints tend to open very little while free-movement joints can open up to 20 mm.

The thermal contraction, Δ , in mm, can be estimated as follows:

$$\Delta_j = (\alpha TL) 10^3 \quad \text{Eqn 8.2}$$

where

L = distance between free-movement joints (m)

T = change in temperature (°C)

α = coefficient of thermal expansion of concrete

The coefficient of thermal expansion is generally assumed in design to be $10 \times 10^{-6}/^\circ\text{C}$ but specific values for concretes made with various aggregates are given in Table 10.1.

It should be noted that joints will close when slab temperatures are raised to ambient conditions potentially causing damage to joint sealants.

8.12 JOINT SEALANTS

8.12.1 Introduction

Joints are provided in concrete floors to allow for drying shrinkage and thermal movements. Filling joints with sealant prevents ingress of debris, which could damage the joint, and supports the joint arris while allowing for limited movement. Some floor designs result in a reduction in the number of joints. In these cases, joints can be subject to greater movements and care must be taken in choosing and installing sealants.

Joint sealants are supplied as liquids or paste-like materials that cure to create a flexible seal. They can have one component, which cures by reaction with the environment, or two components, which cure by reaction of the components after mixing.

Sealants are characterised by their Movement Accommodation Factor (MAF), which is the total movement the sealant can accept in service expressed as a percentage of the original joint width, and by their Shore A hardness value. Typically, floor sealants have MAF values in the range 5–25%, and Shore A hardness values in the range 20–60. Data on some sealant types is given in Table 8.1.

Sealant selection should be based on the level of anticipated movement in service and the need for arris support. Anticipated joints openings should be such that the MAF value is not exceeded. Flexibility and hardness are conflicting qualities in any material and product selection is therefore a compromise.

Guidance can be found in BS 8000-16 *Code of practice for sealing joints in buildings using sealants* ⁽⁴³⁾.

Table 8.1: Sealant types and properties.

Type	Typical MAF	Shore A hardness	Comments
Polyurethane	10–25%	20–35	Softer grades have higher MAF
Polysulfide	10–25%	20–45	
Epoxy polyurethane	10–15%	40–55	Give joint arris support
MS-silyl modified polyether	5–20%	45–60	One component. Give joint arris support

8.12.2 Joints in new floors

Joints are usually sealed once the joint faces have dried out sufficiently to enable good adhesion. In the early stages, the amount of shrinkage is small, but shrinkage will continue for many months. For this reason, sealing should be left as late in the construction process as possible, and ideally just before building handover. This later shrinkage will result in a large proportion of the ultimate movement and therefore a sealant with a high movement capacity is recommended. However, high movement capacity is associated with soft sealants, which will give only limited joint arris support.

Initially, a soft sealant, typically with Shore A hardness below 30 and MAF of 25%, should be used. This should be considered as temporary and be replaced later with a harder sealant that will provide support for the joint arris. These may debond in due course and should be replaced as required.

After about a year, depending on environmental conditions, on-going drying shrinkage will be reducing. It may be expected that the floor will be operating in a narrow temperature range and movement will be lower. Suitable sealants typically have a higher Shore A hardness in the range 35–60 or higher and a lower MAF of 0–20%. It should be noted that all joints will open and close by small amounts in response to temperature and moisture variations.

Some recently introduced sealants combine Shore A hardness values in the range 35–45 with MAF values of around 20% to give good arris support with reasonably high movement capacity.

The bottom surface of the sealant should be isolated from the concrete by using a closed-cell polyethylene foam backer or a siliconised debonding tape. This will allow the joint movement to occur over the entire width of the sealant. The joint should be sealed flush with the concrete surface to eliminate stepping.

Joints and sealants should form part of the long-term monitoring and maintenance regime for the floor – see Sections 8.12.5 and 13.5.

In cold stores, consideration should be given to the use of sealants that can be applied at the operating temperatures, when the joint openings are at their widest.

8.12.3 Sealant application

Joint faces should be cleaned to remove cement slurry, mould oils or any loose materials. The concrete surface needs to be dry before applying the sealant.

Sealants with higher Shore A hardness, as would be used for permanent filling, transfer any applied load through a shearing action against the adhesive bond to the sides of the joint. For a typical sawn joint 4–5 mm wide, the sealant should be at least 20 mm deep.

The sealant should be allowed to cure fully before the joint is trafficked. The rate of cure of sealant is dependant on the ambient temperature and the sealant type. Two-component systems require careful mixing but cure uniformly through the sealant bead and typically take 4–7 days to achieve full cure. One-component sealants cure by reaction with atmospheric moisture or oxygen, forming a surface skin, which gradually thickens. The time for full cure depends on humidity and the dimensions of the sealant section. The sealant manufacturer should be consulted.

8.12.4 Other filling systems

Highly compressed foam strips can be inserted into joints. As they do not rely on adhesion they can be inserted immediately after the saw cutting operation. They also have good movement capacity but give only limited arris support. Arris support is a function of the material density in its compressed state, so the support will reduce as the foam expands to fill a widening joint. They have potential to keep joints free of debris.

When drying shrinkage has reduced the joint is injected with epoxy resin, which fills the open cells of the foam and the void above the filler. The resin will also repair nominal damage that has occurred to arrises and once levelled off will give continuity across the joint. The use of epoxy resins must be compatible with any on-going movement of the joint.

Extruded plastic joint filler systems are also available. These are pressed into the joint after the joint arris has gained sufficient strength so as not to be damaged. They are designed to allow for a small amount of joint opening and give modest arris support. They prevent entry of dirt and debris. As joints open, they can be replaced with ones of wider section.

8.12.5 Maintaining joints

Owners and users of industrial facilities should include the floor, especially the joints and sealants, in the programme of routine monitoring and maintenance of the facility. Maintaining joints effectively avoids the risk of joint failure: sealants should be inspected routinely and remedial action taken where failure has occurred. If repairs are not carried out, the joint sealant, arris, and surrounding floor will deteriorate further, see Chapter 13. All joints will open and close slightly in service, due to variations in temperature and moisture content. Therefore, repairs and replacements should preferably be carried out when the floor is at its lowest temperature.

9 STRENGTH AND SERVICEABILITY OF SLABS

SYMBOLS

a	equivalent contact radius of a load (mm)	$P_{app,fab}$	load-transfer capacity of fabric (kN/m)
A	cross-sectional area of dowel (mm ²)	P_{bear}	bearing capacity per dowel (kN)
A_v	shear area taken as $0.9 \times$ the area of the section ($\pi d^2/4$ for round and d^2 for square bars) (mm ²)	P_{bend}	bending capacity per dowel (kN)
b_1	effective bearing length, taken as not greater than $8d_d$ (mm)	P_{lin}	ultimate line load capacity (kN/m)
d	effective depth (mm)	$P_{lin,n}$	ultimate line load capacity controlled by negative bending moment (kN/m)
d_d	diameter of dowel (mm)	$P_{lin,p}$	ultimate line load capacity controlled by positive bending moment (kN/m)
E_{cm}	secant modulus of elasticity of concrete (kN/mm ²)	P_p	load capacity in punching (kN)
$E_{cm(t)}$	secant modulus of elasticity of concrete modified due to creep (kN/mm ²)	$P_{p,max}$	maximum load capacity in punching (kN/m)
E_s	modulus of elasticity of steel (N/mm ²)	P_{sh}	shear capacity per dowel (kN)
f_{cd}	design compressive strength of concrete (cylinder) (N/mm ²)	P_u	ultimate capacity under concentrated load (kN)
f_{ck}	characteristic compressive strength of concrete (cylinder) (N/mm ²)	$R_{c,3}$	equivalent flexural strength ratio
f_{ctd}	design axial tensile strength of concrete (N/mm ²)	T	change in temperature (°C)
$f_{ctd,\Omega}$	design flexural strength of plain concrete (N/mm ²)	u_0	length of punching perimeter at the face of the loaded area (mm)
$f_{ctk(0.05)}$	characteristic axial tensile strength of concrete (5% fractile) (N/mm ²)	u_1	length of critical punching perimeter (mm)
$f_{ctk,\Omega}$	characteristic flexural strength of plain concrete (N/mm ²)	v_f	additional shear stress provided by steel fibres (N/mm ²)
f_{cm}	mean compressive strength of concrete (cylinder) (N/mm ²)	v_{max}	maximum shear stress (N/mm ²)
f_{ctm}	mean axial tensile strength of concrete (N/mm ²)	v_p	shear stress on punching perimeter (N/mm ²)
f_{cu}	characteristic compressive strength of concrete (cube) (N/mm ²)	w	load per unit area (kN/m ²)
f_y	characteristic strength of steel (N/mm ²)	x	joint opening (mm)
F	shear shape factor (6/5 for square dowels and 10/9 for round dowels)	Z_p	plastic section modulus of the dowel (mm ³)
G	shear modulus of dowel (kN/mm ²)	α	coefficient of linear thermal expansion ($10^{-6}/^{\circ}C$) also faction applied to characteristic strength (Section 9.6.2)
h	slab thickness (mm)	δ_d	deflection of dowel (mm)
I	moment of inertia of dowel (mm ⁴)	Δ_j	thermal contraction (mm)
k	modulus of subgrade reaction (N/mm ³)	Δ_t	difference in temperature between the upper and lower surfaces of the slab (°C)
k_1, k_2	factors used in shear calculations	ϵ_{sh}	long-term shrinkage strain (mm)
l	radius of relative stiffness (mm)	γ_c	partial safety factor for concrete
M_n	ultimate negative (hogging) resistance moment of the slab (kNm)	γ_f	partial safety factor for loads
M_p	ultimate positive (sagging) resistance moment of the slab (kNm)	γ_s	partial safety factor for steel
P	applied load per dowel (kN)	ϕ	creep factor
P_{app}	load-transfer capacity per dowel in combined bending and shear (kN)	λ	factor determined from Equation 9.15
		μ	coefficient of friction
		ν	Poisson's ratio (ratio of lateral to longitudinal strain)
		ρ_x, ρ_y	percentage of reinforcement by area in the x- and y-directions, respectively

9.1 INTRODUCTION

Traditionally, ground-supported slabs have been designed by elastic methods. The elastic analysis equations developed in the 1920s by Westergaard^(26, 27) are still used extensively worldwide for the design of ground-supported slabs. Such slabs are relatively thick and so assessment of deflections and other in-service requirements has generally not been necessary. As methods of analysis have developed, so slabs have become thinner. By using plastic methods of analysis, compatible with BS 8110⁽¹⁵⁾ and the draft Eurocode 2⁽¹⁶⁾, load transfer across joints and in-service requirements, such as deflections and crack control, have become more significant and need to be evaluated.

The design approaches in this Chapter consider both the ultimate and serviceability conditions, as outlined in Section 9.3. Determination of the strength of the slab is based on plastic analysis. This requires that the slab has adequate ductility, i.e. that it contains sufficient fibres or reinforcement to provide adequate post-cracking behaviour. (Sections 9.4.2 and 9.4.3 give the required minimum amounts of steel and synthetic fibres, respectively, and Appendix E provides guidance on steel fabric.) The use of plastic methods of analysis for plain concrete slabs, or for slabs with less than the minimum amount of fibres or reinforcement in the concrete, is not appropriate due to the lack of ductility. Hence, they should still be designed by elastic methods (see BCA Technical Report 550⁽⁴⁴⁾ and Interim Technical Note 11⁽⁴⁵⁾).

Equations are provided for the following:

- bending capacity under point loads
- capacity under line loads and uniformly distributed loads
- load transfer across joints
- punching
- deflections.

For nominally loaded floors, reference may be made to Section 3.1. A worked example of the thickness design of a heavily loaded floor using the principles set out in this Chapter is given in Appendix B. This is extended in Appendix E to cover the use of fabric reinforcement.

9.2 UNITS

The following units are used for calculations:

forces and loads	kN, kN/m, kN/m ²
moments (bending)	kNm
modulus of subgrade reaction	N/mm ³
radius of relative stiffness	mm
slab depth	mm
stresses and strengths	N/mm ²
unit mass	kg/m ³
unit weight	kN/m ³

9.3 DESIGN PRINCIPLES AND CRITERIA

9.3.1 Introduction

The design procedure is in limit state format, in line with modern codes such as BS 8110, *Structural use of concrete*⁽¹⁵⁾ and the draft Eurocode 2, *Design of concrete structures*⁽¹⁶⁾. Partial safety factors are applied to the loads and to the properties of the materials. Design checks are carried out on both the strength and serviceability of the slab. The design formulae are, where appropriate, similar to those used in the draft Eurocode 2. However, it must be emphasised that neither the Eurocode nor the associated National Annex are currently finalised. Hence, the expressions used may be changed in the final, implemented versions, which may necessitate a review of the proposed design clauses. It should be noted that there are some differences in terminology between current British Codes and the draft Eurocodes, namely:

- Loads are referred to as **actions**
- Superimposed loads are **variable actions, Q**
- Self-weight and dead loads are **permanent actions, G**.

9.3.2 Ultimate limit state

The parameters controlling the design of ground-supported slabs at the ultimate limit state are not as clear-cut as for general reinforced concrete design, where 'ultimate' refers to the strength of the structure and 'serviceability' to the limitation of crack widths, deflections etc. For ground-supported slabs, two ultimate strength modes of failure of the concrete slab are possible, namely flexure (bending) and local punching. Slab design for flexure at the ultimate limit state is based on yield line theory, which requires adequate ductility to assume plastic behaviour. (Ductility requirements are discussed in Section 9.4 and Appendix E.) At the ultimate limit state, the bending moment along the sagging yield lines may be assumed to be the full plastic (or residual post-cracking) value. However, a principal requirement in the design of ground-supported slabs is the avoidance of cracks on the upper surface. Hence, at the ultimate limit state the bending moment of the slab along the hogging yield lines is limited to the design cracking moment of the concrete, with the partial safety factors appropriate to the ultimate limit state. Clearly there is a requirement for sufficient rotation capacity of the sagging yield lines so that the hogging moment capacity is mobilised.

In some circumstances, shrinkage and temperature changes may lead to significant tensile stresses in slabs. This could cause problems in any area in which the applied loading leads to a significant hogging moment, such as areas between uniformly distributed loads, see Section 9.9.5. It could also apply to aisles between racking, where the pattern of individual leg loads can be considered to be equivalent to strips of uniformly distributed loading on either side of the aisle. In these cases the assumed flexural tensile strength of the concrete, and hence the cracking moment, should be reduced by an appropriate amount, see Section 9.12.3.

The design against punching shear of the slab around concentrated loads is based on the approach in the draft Eurocode 2 for suspended slabs. It is thus a conservative approach as it takes no account of the fact that some of the load will be transferred directly through the slab to the ground.

One of the critical loading cases is likely to be a concentrated load close to an edge or corner, which is across joints. Hence, a major design consideration is the transfer of load between slabs, either by means of the reinforcement in the slab or by dowels or proprietary load-transfer systems and by aggregate interlock.

Slab tests ^(46, 47) have demonstrated that enhancement of load-bearing capacity occurs as a result of arching (membrane) action. Further research may allow membrane action to be included in the thickness design of ground-supported slabs but it is not considered here.

Pile-supported slabs are designed as 'conventional' structures in accordance with BS 8110 or the draft Eurocode 2, using the normal approach for the ultimate limit state.

9.3.3 Serviceability

As indicated above, the design process for ground-supported slabs should avoid the formation of cracks on the top surface due to the imposed loads. Depending on the operating conditions, checks may be required on the overall deflection of the slab and, more importantly, when mobile handling equipment is used, differential deflections across joints.

For pile-supported slabs crack widths and slab deflections will be controlled by the design guidelines in BS 8110 or the draft Eurocode 2. Additional information is given in Appendix D.

9.4 MATERIAL PROPERTIES

9.4.1 Concrete

Various properties of concrete are listed in Table 9.1. These are based on the equivalent Table in the draft Eurocode 2; the two shaded columns are additional to those in the Eurocode.

The characteristic flexural strength of plain concrete should be taken as:

$$f_{\text{ctk,fl}} = \left[1 + (200/h)^{0.5} \right] f_{\text{ctk}(0.05)} \leq 2f_{\text{ctk}(0.05)} \quad \text{Eqn 9.1}$$

where

$$h = \text{total slab thickness, mm } (h > 100 \text{ mm}).$$

The minimum shear strength of concrete should be taken as:

$$v_{\text{Rd,ct}} = 0.035 k_1^{3/2} f_{\text{ck}}^{1/2} \quad \text{Eqn 9.2}$$

where

$$k_1 = 1 + (200/d)^{0.5}$$

$$d = \text{effective depth}$$

9.4.2 Steel-fibre-reinforced concrete

The equivalent flexural strength ratio, $R_{e,3}$, for fibre-reinforced concretes, is mainly dependent on fibre type and dosage. It is determined experimentally, see Section 7.4. The fibre dosage should be sufficient to give a value of $R_{e,3}$ of at least 0.3, otherwise the concrete should be treated as plain.

9.4.3 Synthetic-fibre-reinforced concrete

At the normal dosage of about 0.9 kg/m³, short synthetic microfibres do not enhance the ductility of concrete and hence slabs containing such fibres should be designed as though they were plain concrete ⁽⁴⁷⁾. However, certain types and dosages of structural synthetic fibres will give suitable values of $R_{e,3}$, the flexural strength ratio, determined experimentally as for steel fibres, see Section 7.5. Guidance on the suitability of the synthetic fibres, and in particular their response to long-term loading, should be sought from the manufacturer. As for steel fibres, the fibre dosage should be sufficient to give an $R_{e,3}$ value of at least 0.3, otherwise the concrete should be treated as plain.

9.4.4 Steel fabric and bar

Steel fabric should be in accordance with BS 4483 ⁽³⁹⁾. Dimensions of standard square fabrics are given in Table 9.2. (BS 4483 will be replaced by EN 10080 ⁽³⁷⁾ in due course.) Design guidance for fabric is given in Appendix E.

Table 9.1: Strength properties for concrete. (The two shaded columns are additional to those in the draft Eurocode 2.)

Symbol	Property	Strength class			Units	Explanation	
f_{cu}	Characteristic compressive strength (cube)	30	35	40	45	N/mm ²	Cube strength
f_{ck}	Characteristic compressive strength (cylinder)	25	28	32	35	N/mm ²	Cylinder strength
f_{cm}	Mean compressive strength (cylinder)	33	37	40	43	N/mm ²	$f_{\text{ck}} + 8$
f_{ctm}	Mean axial tensile strength	2.6	2.8	3.0	3.2	N/mm ²	$0.3 f_{\text{ck}}^{2/3}$
$f_{\text{ctk}(0.05)}$	Characteristic axial tensile strength (5% fractile)	1.8	2.0	2.1	2.2	N/mm ²	$0.7 f_{\text{ctm}}$
E_{cm}	Secant modulus of elasticity	31	32	33	34	kN/mm ²	$22(f_{\text{cm}}/10)^{0.3}$

Table 9.2: Dimensions of standard square fabrics.

BS reference	Bar diameter (mm)	Bar spacing (mm)	Cross-sectional area per m width (mm ²)
A142	6	200	142
A193	7	200	193
A252	8	200	252
A393	10	200	393

Steel bar should be in accordance with BS 4449⁽³⁶⁾, with a characteristic strength of 460 N/mm² for high yield steel or 250 N/mm² for mild steel. (BS 4449 will be replaced by EN 10080⁽³⁷⁾ in due course, in which the characteristic strength is 500 N/mm².) See also Section 9.6.2.

9.4.5 Modulus of subgrade reaction

The modulus of subgrade reaction, k , see Section 6.2.2, is the load per unit area causing unit deflection and has the units N/mm³. Typical values for k , which may be used in design in the absence of more accurate information, are given in Table 6.2.

9.4.6 Radius of relative stiffness

In addition to the modulus of subgrade reaction, k , Westergaard^(26, 27) introduced the concept of the radius of relative stiffness, l , which is determined by calculating the fourth root of the concrete slab stiffness divided by the modulus of subgrade reaction. The slab stiffness is defined as:

$$E_{cm} h^3 / 12(1 - \nu^2) \quad \text{Eqn 9.3}$$

where

E_{cm} = short-term modulus of elasticity of the concrete (N/mm²)

h = slab thickness (mm)

ν = Poisson's ratio (ratio of lateral to longitudinal strain).

The radius of relative stiffness, l , is thus:

$$l = \left[E_{cm} h^3 / 12(1 - \nu^2) k \right]^{0.25} \quad \text{Eqn 9.4}$$

The physical significance of l is explained below and by reference to Figure 9.1.

The bending moment under a concentrated load P_1 is at a maximum and positive (tension at the bottom of the slab) directly under the load. Along a radial line, the moment remains positive and decreases to zero at a distance $1.0 l$ from the load. It then becomes negative and is at its maximum at $2.0 l$ from the load. The maximum negative moment (tension on the top of the slab) is significantly less than the maximum positive moment. The moment approaches zero at $3.0 l$ from the load.

The influence of an additional load P_2 at any distance x from A is as follows:

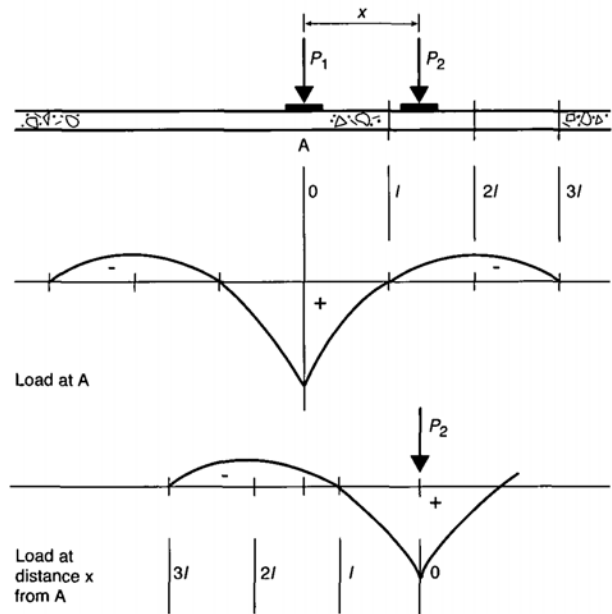

Figure 9.1: Approximate distribution of bending moments for an internal load.

- If $x < l$, the positive bending moment at A will increase.
- If $l < x < 3l$, the positive bending moment at A will decrease, but by a relatively small amount.
- If $x > 3l$, the additional load will have negligible influence on the bending moment at A.

It is also useful to examine how the factors included in Equation 9.4 will influence the value of l .

- In the draft Eurocode 2, Poisson's ratio for concrete is taken as 0.20. Thus $(1 - \nu^2) = 0.96$ and has little influence on the value of l .
- The modulus of elasticity of concrete (short-term) may be obtained from the following equation from the draft Eurocode 2:

$$E_{cm} = 22 (f_{cm} / 10)^{0.3} \quad \text{Eqn 9.5}$$

where

f_{cm} = mean compressive strength of concrete (cylinder), see Table 9.1.

Therefore l increases with E_{cm} .

- The smaller the value of k , the higher the value of l .
- Clearly the value of l will increase with increase in the slab depth h .

The influence of k and h on values of l is illustrated in Table 9.3, in which E_{cm} is taken as 33 kN/mm².

9.5 ACTIONS (LOADS)

Guidance on establishing the required values for uniformly distributed loads, line loads and point loads is given in

Table 9.3: Influence of slab depth h and modulus of subgrade reaction k on the radius of relative stiffness l for $f_{cu} = 40 \text{ N/mm}^2$.

Slab depth h (mm)	Values of l (mm) for $k = 0.01$ to 0.10									
	0.01	0.02	0.03	0.04	0.05	0.06	0.07	0.08	0.09	0.10
150	992	834	753	701	663	634	610	590	572	558
175	1113	936	846	787	744	711	684	662	643	626
200	1230	1035	935	870	823	786	756	732	710	692
225	1364	1130	1021	950	899	859	826	799	776	756
250	1455	1223	1105	1029	973	929	894	865	840	818
275	1562	1314	1187	1105	1045	998	960	929	902	879
300	1668	1402	1267	1179	1115	1066	1025	992	963	938

Chapter 3, but actual loads depend on the use of the structure, type of mechanical handling equipment, storage systems, and the design brief (Appendix A).

9.6 PARTIAL SAFETY FACTORS

9.6.1 General

The 1994 edition of TR 34⁽⁴¹⁾ recommended that a global safety factor of 1.5 should be applied to permanent actions (e.g. racking, mezzanines). For materials handling equipment the global safety factor ranged from 1.5 to 2.0 according to the number of movements.

This edition of TR 34 uses a plastic analysis for the most common load cases, which are point loads, and applies partial safety factors in line with current design codes. However, a suitable plastic analysis for line loads and uniformly distributed loads could not be identified and so the elastic analysis of the 1994 edition is continued along with its associated global safety factor of 1.5.

The separate partial safety factors for point loads and materials result in equivalent global factors that are higher than those in the 1994 edition, though this has been largely offset by the use of less conservative design approaches. This is discussed further in Section 1.5. Different partial safety factors are used for static and dynamic loads.

It should be emphasised that the partial safety factors are compatible with the recommended design equations. If other design methods are used (see Section 9.7.2) different safety factors could be used provided that the resulting design has an equivalent overall factor of safety.

9.6.2 Partial safety factors for materials

Ultimate limit state (ULS)

The following partial safety factors for materials at the ultimate limit state are adopted:

- bar and steel fabric reinforcement, γ_s
 - in accordance with BS 4449⁽³⁶⁾ with a characteristic strength of 460 N/mm² 1.05

- in accordance with BS EN 10080⁽³⁷⁾ with a characteristic strength of 500 N/mm² 1.15

- plain concrete and steel-fibre-reinforced concrete (SFRC), γ_c 1.5

The draft Eurocode 2 relates the design value of a concrete property (e.g. its tensile strength) to its characteristic value:

$$\text{Design value} = \alpha \times \text{characteristic value} / \gamma$$

Draft Eurocode 2 recommends that α be taken as 1.0. Hence the term has not been shown in the subsequent equations in this Chapter. However, the UK National Application Document may recommend a value of $\alpha = 0.85$. In this case it would be necessary to modify the equations where appropriate: it should be noted that this would significantly increase slab thickness.

Serviceability limit state (SLS)

For the serviceability limit state the partial safety factor for materials should be taken as unity.

9.6.3 Partial safety factors for actions

Ultimate limit state (ULS)

For the ultimate limit state the following partial safety factors γ_f should be adopted:

- for permanent actions (e.g. racking) 1.2*
- for variable actions (e.g. random loading) 1.5
- for dynamic actions (e.g. materials handling equipment and machinery subject to vibration) 1.6

* Note: This is at variance with the draft Eurocode for loads⁽⁴⁸⁾ but racking loads are considered to be well controlled.

When considering mezzanine floors and the loads transmitted from them to a ground-supported slab the partial safety factors in BS 8110 or the draft Eurocodes should be used.

Serviceability limit state (SLS)

For the serviceability limit state the partial safety factor for actions (permanent and variable) should be taken as unity.

9.7 YIELD LINE THEORY

9.7.1 Basic approach for point loads

Figure 9.2 shows the case of a single concentrated load applied internally over a small circular area on a large concrete ground-supported slab. As the load increases, the flexural stresses below the load will become equal to the flexural strength of the concrete. The slab will begin to yield, leading to radial tension cracks in the bottom of the slab caused by positive tangential moments.

The moment per unit length at which the flexural tensile strength of the concrete is reached is given by:

$$M = f_{ctk,n} (h^2 / 6) \quad \text{Eqn 9.6}$$

where

h = slab depth (mm)

$f_{ctk,n}$ = characteristic flexural strength of the plain concrete (N/mm²), see Equation 9.1.

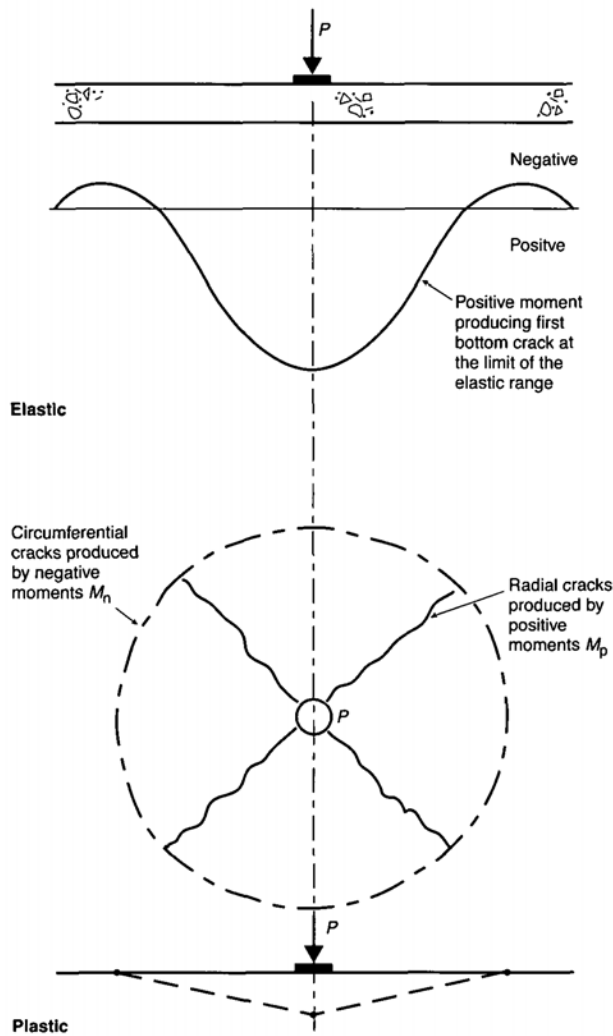

Figure 9.2: Development of radial and circumferential cracks in a concrete ground-supported slab.

With further increases in load, it is assumed that the moments are redistributed and there is no further increase in positive moment, but a substantial increase in circumferential moment some distance away from the loaded area. Tensile cracking occurs in the top of the slab when the maximum negative circumferential moment exceeds the negative moment capacity of the slab. When this condition is reached with the development of visible circumferential cracks in the top of the slab, failure is considered to have occurred. Using conventional yield line theory with $a = 0$ (i.e. a true point load) and ignoring the contribution of the subgrade reaction, it can be shown that the collapse load, P_u , in flexure is given by:

$$P_u = 2\pi(M_p + M_n) \quad \text{Eqn 9.7}$$

where

M_n = ultimate negative (hogging) resistance moment of the slab

M_p = ultimate positive (sagging) resistance moment of the slab.

The development of yield line patterns in a ground-supported slab assumes that the slab has adequate ductility and has not failed in punching. The yield line pattern shown in Figure 9.2 cannot be assumed in a pre-cracked slab. Any such cracks may create an edge condition rather than a centre condition, see Section 9.9.2.

9.7.2 Development of analyses for ground-supported slabs

In 1962, Meyerhof⁽⁴⁹⁾ used an ultimate strength analysis of slabs based on plastic analysis (yield line theory) and obtained design formulae for single internal, edge and corner loads. He also considered combined loads.

In 1978, Losberg⁽⁵⁰⁾ developed his earlier (1961) work to propose a yield line analysis for ground-supported slabs and advocated the use of structurally active reinforcement rather than so-called 'crack control reinforcement' which, he argued, is mainly too weak to prevent the formation of cracks or to control crack widths. The structurally active reinforcement is placed in the bottom of the slab (typically 0.25 to 0.35%) and this steel provides the sagging (positive) moment capacity. The hogging (negative) moment capacity is taken as the flexural strength of the plain concrete. Allowance is also made for the influence of shrinkage and temperature variation.

In 1983, Baumann and Weisgerber⁽⁵¹⁾ developed a yield line method to determine collapse loads of ground-supported slabs. Expressions were derived for the collapse load of a slab with an interior load, free-edge load and free corner load. As with Losberg's approach, reinforcing steel is assumed to contribute to the positive resistance moment only. Comparisons were made with previous analyses by Losberg and Meyerhof and there was reasonable correlation, the Baumann and Weisgerber approach being somewhat conservative.

In 1986, Rao and Singh⁽⁵²⁾ presented a slab design method in which collapse loads were predicted by using rigid plastic

behaviour and square yield criteria of failure for concrete. The Meyerhof, and Rao and Singh approaches are similar, with the important difference that boundary shear equilibrium was ignored by Meyerhof. Further, Rao and Singh consider two modes of collapse, semi-rigid and rigid:

- (a) Semi-rigid: the loading is flexible, typically a wheel on a pavement, and a plastic hinge is formed at the base of the slab inside the loaded area.
- (b) Rigid: the loading is rigid, for example, a column cast monolithically with the slab, and a plastic hinge is formed at the base of the slab around the column.

Formulae were derived for interior, edge and corner loading.

9.8 DESIGN MOMENT CAPACITIES

It should be noted that the following equations include the term h , the overall slab thickness. It may be necessary to modify this locally, for example, when baseplates are set into the slab or where guide wires are installed in grooves that may not be adequately filled with an epoxy resin.

9.8.1 Steel-fibre-reinforced concrete

The ductility of steel-fibre-reinforced concrete is characterised by its equivalent flexural strength ratio, $R_{e,3}$, which is defined in Section 7.4. This provides a residual (i.e. post-cracking) positive bending moment capacity, M_p , as follows:

$$M_p = \frac{f_{ctk,fl}}{\gamma_c} (R_{e,3}) \left(\frac{h^2}{6} \right) \quad \text{Eqn 9.8}$$

As indicated in Section 9.4.2, sufficient fibres must be provided to give a minimum $R_{e,3}$ value of 0.3. For design purposes it is assumed that the limiting criterion is the onset of cracking on the top surface. While fibres increase the ductility they do not affect the cracking stress, i.e. they do not increase the negative bending moment capacity, M_n , and hence the value obtained from Equation 9.6 should be used:

$$M_n = \frac{f_{ctk,fl}}{\gamma_c} \left(\frac{h^2}{6} \right) \quad \text{Eqn 9.9}$$

9.8.2 Synthetic-fibre-reinforced concrete

As indicated in Section 9.4.3, short synthetic fibres at the normal dosage of 0.9 kg/m³ do not enhance the ductility of concrete and hence such slabs should be designed as though they were plain concrete. However, limited tests on concrete containing significantly higher dosage rates of structural synthetic fibres have indicated that some ductility can be achieved. The manufacturer of the structural synthetic fibre should be consulted; if sufficient ductility can be demonstrated, that is, if the concrete has a minimum $R_{e,3}$ value of 0.3, (see also Section 7.5) the same design equations as for steel-fibre-reinforced concrete may be used.

9.8.3 Reinforced concrete (bar and fabric)

Fabric reinforcement is generally provided for crack control purposes and has not been considered as contributing to the

load-carrying capacity of ground-supported slabs. Based on tests and research, a proposed design method has been developed for fabric. Details are given in Appendix E, which provides design guidance specific to steel fabric based on the design equations in the following section, and extends the worked example in Appendix B.

9.9 DESIGN EQUATIONS

9.9.1 Introduction

On the basis of comparisons with the various approaches outlined in Section 9.7.2, the Meyerhof equations would appear to be the most straightforward. They have been adopted for slab analysis at the ultimate limit state in this report along with partial safety factors based on those in the draft Eurocode 2.

9.9.2 Load locations

Three loading locations (see Figure 9.3) are considered in design as follows:

- **internal** – the centre of the load is located more than $(l + a)$ from an edge (i.e. a free edge or a joint)
- **edge** – the centre of the load is located on an edge more than $(l + a)$ from a corner (i.e. a free corner or the intersection of two joints)
- **corner** – the centre of the load is located a from the two edges forming a corner.

where

a = equivalent contact radius of the load

l = radius of relative stiffness.

Linear interpolation should be used for loads at intermediate locations.

For each location, a pair of equations is given to estimate the ultimate load capacity (P_u) of ground-supported slabs subjected to a single concentrated load, see Equations 9.10a and 9.10b to 9.12a and 9.12b. The first equation of each pair is for a true point load. The second is for a concentrated load

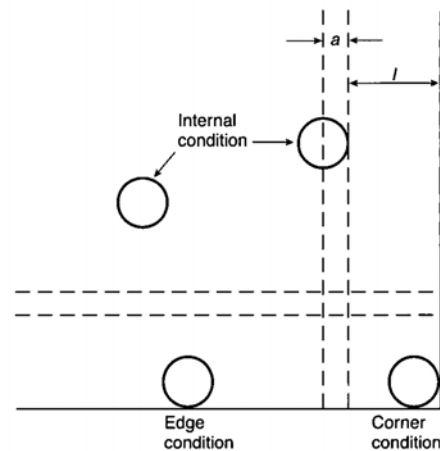

Figure 9.3: Definitions of loading locations.

and is valid for $a/l > 0.2$. Linear interpolation should be used for values of $0 < a/l < 0.2$.

It should be noted that loadings of edges and corners at abutting joints and joint intersections are dealt with in the same way as the edges and corners to be found at, for example, the perimeter of a building. However, loadings at joints and intersections can be reduced by load transfer through dowels or other load-transfer mechanisms, see Section 9.10.

9.9.3 Point loads

Single point loads

In order to calculate the stresses imposed by a point load it is necessary to know the size of the load and the radius of the contact area, a . As baseplates and the footprints of truck wheels are generally rectangular, the actual contact area is established, from which the radius of an equivalent circle is calculated.

In the absence of contact area details for pneumatic wheel loads, the contact area can be calculated using the load and the tyre pressure. For other types of wheel, the manufacturer should be consulted for information on the load and contact area.

Combinations of point loads

Where point loads are in close proximity, they can be considered to act jointly as one load on a contact area that is equivalent to the baseplate areas expressed as circles plus the

area between them, as shown in Figure 9.4. This will typically be the case for back-to-back racking leg loads that have centres 250–350 mm apart or twin-tyred truck wheels. This method should be used for pairs of loads at centres up to twice the slab depth. Otherwise the combined behaviour should be determined from Equations 9.13a and b.

It may also apply to combinations of stacker truck wheels and racking legs when picking or placing pallets. In these positions, the load-side front wheel is often carrying the maximum load of the truck. Truck manufacturers' data should be consulted. A typical layout for very narrow aisles is shown in Figure 9.5. Note that the more onerous condition could occur when dimension H is at a minimum when the truck is passing the racking leg with the carried load centrally positioned.

Examples illustrating the application of the above guidelines for two adjacent racking legs and a racking leg and wheel combination are given in Appendix B.

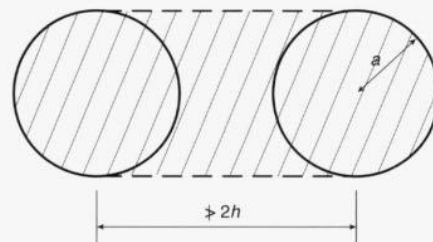

Figure 9.4: Calculation of equivalent contact area for two adjacent point loads.

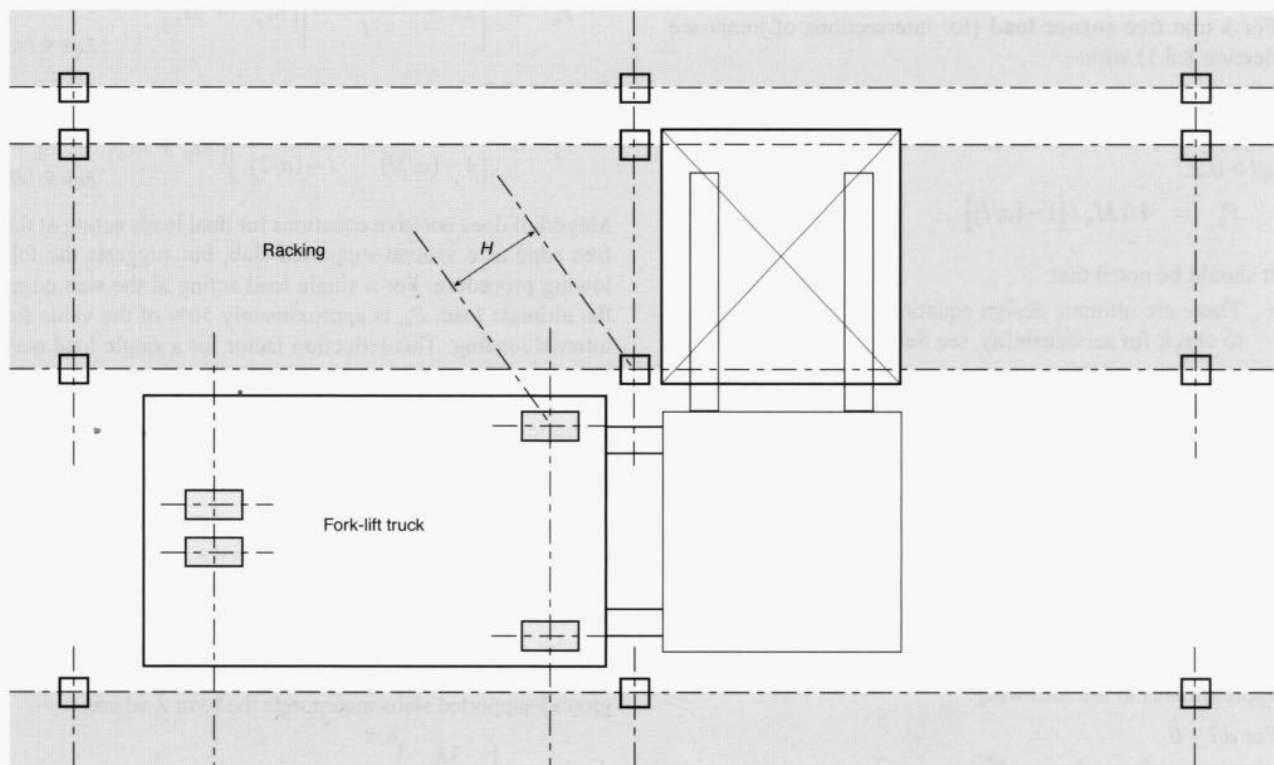

Figure 9.5: Adjacent point loads in very narrow aisles.

Where the centres of the contact areas are at a distance apart that is greater than the radius of relative stiffness (l), then it can be assumed that the stresses induced by one point load have minimal influence on the other.

Design equations

The following equations for internal loads (Equations 9.10a and 9.10b) and for free-edge loads (Equations 9.11a and 9.11b) are taken from Meyerhof's paper. Meyerhof is not explicit in dealing with values of $a/l < 2$. However test results^(53,54) have shown that reasonable agreement between theoretical and test values is obtained if linear interpolation for values of a/l between 0 and 0.2 is adopted.

For an **internal load** with:

$$a/l = 0: \quad P_u = 2\pi (M_p + M_n) \quad \text{Eqn 9.10a}$$

$$a/l > 0.2: \quad P_u = 4\pi (M_p + M_n) / \left[1 - \frac{a}{3l} \right] \quad \text{Eqn 9.10b}$$

For an **edge load** with:

$$a/l = 0: \quad P_u = \left[\pi (M_p + M_n) / 2 \right] + 2M_n \quad \text{Eqn 9.11a}$$

$$a/l > 0.2: \quad P_u = \left[\pi (M_p + M_n) + 4M_n \right] / \left[1 - \frac{2a}{3l} \right] \quad \text{Eqn 9.11b}$$

For a true free **corner load** (for intersections of joints see Section 8.8.1) with:

$$a/l = 0: \quad P_u = 2M_n \quad \text{Eqn 9.12a}$$

$$a/l > 0.2: \quad P_u = 4.0M_n / [1 - (a/l)] \quad \text{Eqn 9.12b}$$

It should be noted that:

- These are ultimate design equations. It is necessary also to check for serviceability, see Section 9.12.
- The equations deal with flexure only and it is essential to check for punching shear, see Section 9.11.

9.9.4 Multiple point loads

Equations 9.10 to 9.12 relate to a single concentrated load. The following equations (taken from Meyerhof's paper⁽⁴⁹⁾) should be used for combined internal loads, see Figure 9.6.

For **dual point loads**, where the centre-line spacing x is less than $2h$ (twice the slab depth), use the simplified approach given in Section 9.9.3. Otherwise, the **total** collapse load approximates to the following:

$$\text{For } a/l = 0 \quad P_u = \left[2\pi + (1.8x/l) \right] [M_p + M_n] \quad \text{Eqn 9.13a}$$

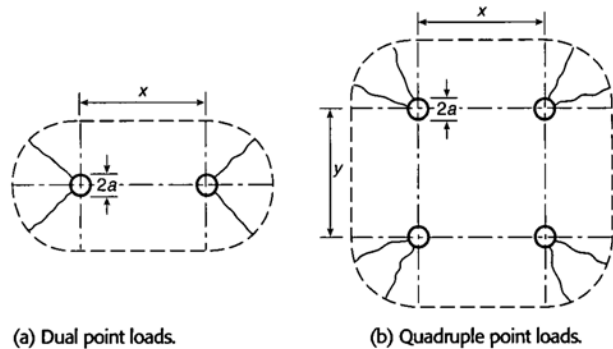

(a) Dual point loads.

(b) Quadruple point loads.

Figure 9.6: Yield line patterns for multiple point loads.

For $a/l > 0.2$

$$P_u = \left[\frac{4\pi}{1 - (a/3l)} + \frac{1.8x}{l - (a/2)} \right] [M_p + M_n] \quad \text{Eqn 9.13b}$$

As the centre-line spacing of the dual point loads increases, the **total** collapse load approaches the upper limit given by the sum of the collapse loads, obtained from Equations 9.10a and 9.10b.

For **quadruple point loads** with centre-line spacings of x and y , the **total** collapse load is given by the sum of the collapse loads of the individual point loads (Equations 9.10a and 9.10b) or by the sum of collapse loads of the individual dual point loads or by the following approximate total collapse load, whichever gives the smaller value:

For $a/l = 0$

$$P_u = \left[2\pi + \frac{1.8(x+y)}{l} \right] [M_p + M_n] \quad \text{Eqn 9.14a}$$

For $a/l > 0.2$

$$P_u = \left[\frac{4\pi}{1 - (a/3l)} + \frac{1.8(x+y)}{l - (a/2)} \right] [M_p + M_n] \quad \text{Eqn 9.14b}$$

Meyerhof does not give equations for dual loads acting at the free edge of a ground-supported slab, but suggests the following procedure. For a single load acting at the slab edge, the ultimate load, P_u , is approximately 50% of the value for internal loading. This reduction factor for a single load may be used with good approximation for multiple point loads. Thus the value of P_u obtained from Equations 9.13 or 9.14 is multiplied by a factor of 0.5 for free-edge loads.

9.9.5 Line loads and uniformly distributed loads

The elastic analysis based on the work of Hetenyi⁽⁵⁵⁾ is adopted here. This analysis has traditionally used a global safety factor of 1.5, which should continue to be used instead of the partial safety factors used for point loads. In practice, having applied a factor of 1.5 to materials, an additional factor need not be applied to the load. His equations for determining moments in ground-supported slabs incorporate the term λ where:

$$\lambda = \left(\frac{3k}{E_{cm} h^3} \right)^{0.25} \quad \text{Eqn 9.15}$$

where

k = modulus of subgrade reaction

E_{cm} = secant modulus of elasticity of the concrete

The factor λ is referred to as the 'characteristic' of the system and since its dimension is (length)⁻¹ the term $(1/\lambda)$ is referred to as the 'characteristic length'.

Line loads

Hetenyi's analysis determined that the distribution of bending moment induced by a line load applied to a slab is as shown in Figure 9.7, with $M_n = 0.21M_p$.

Thus the load capacity of the slab per unit length, P_{lin} , is the lesser of the capacities determined from the following equations:

$$P_{lin,p} = 4\lambda M_p \tag{Eqn 9.16}$$

and

$$P_{lin,n} = \frac{4}{0.21} \lambda M_n \tag{Eqn 9.17}$$

where

$P_{lin,p}$ = ultimate line load capacity controlled by positive bending moment

$P_{lin,n}$ = ultimate line load capacity controlled by negative bending moment.

As this is based on an elastic distribution of bending moment, M_p as well as M_n should be taken as the cracking moment, i.e. the value from Equation 9.6. The residual moment (e.g. from Equation 9.8 for fibre-reinforced concrete) should not be used. Thus Equation 9.16 will govern.

Uniformly distributed loads

A common example of uniformly distributed loading is block stacking. For the general case where the slab will be subjected to a random pattern of uniformly distributed

loading, it has been found that the maximum positive (sagging) bending moment in the slab is caused by a patch load of breadth $(\pi/2\lambda)$ as shown in the upper part of Figure 9.8. For example, taking a slab depth $h = 175$ mm, $E_{cm} = 33$ kN/mm² and $k = 0.05$ N/mm³, a patch load of breadth $\pi/2\lambda = 1.64$ m will cause the maximum positive bending moment.

The maximum negative (hogging) moment is induced between the pair of loads each of breadth π/λ spaced at $\pi/2\lambda$ apart, as shown in Figure 9.8. This spacing is known as the critical aisle width. Wider spacing or narrower spacing of the loaded areas will lead to lower bending moments. As indicated in Section 9.3.2, this is a situation in which differential shrinkage and temperature changes may lead to significant tensile stresses. In the absence of more detailed calculations (see Section 9.12.3) it should be assumed that these stresses are equivalent to 1.5 N/mm² and this figure should be deducted from the value of $f_{ctk,n}$ used in Equation 9.6 to determine M_n . However, it should be noted that in floors with heavy block stacking, the aisle widths are unlikely to be at the critical dimensions and the analysis should be based on the actual aisle and load widths as described below.

The load capacity per unit area, w , is given by the lesser of:

$$w = \frac{1}{0.161} \lambda^2 M_p \tag{Eqn 9.18}$$

and

$$w = \frac{1}{0.168} \lambda^2 M_n \tag{Eqn 9.19}$$

As with line loads, this is based on an elastic distribution of bending moment, therefore M_p as well as M_n should be taken as the cracking moment, i.e. the value from Equation 9.6. The residual moment (e.g. from Equation 9.8 for fibre-reinforced concrete) should not be used. Thus Equation 9.19 will govern.

It should be noted that the installation of guide wires in the top surface of the slab in aisles between racking may weaken

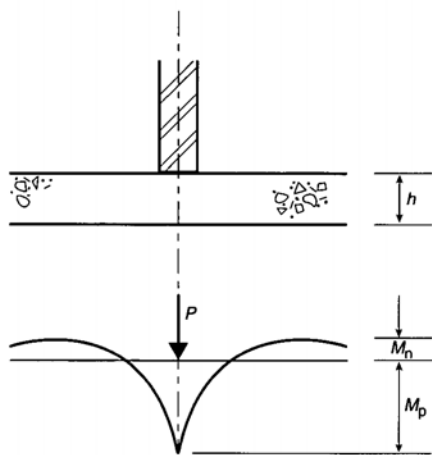

Figure 9.7: Use of Hetenyi's equations for a line load P .

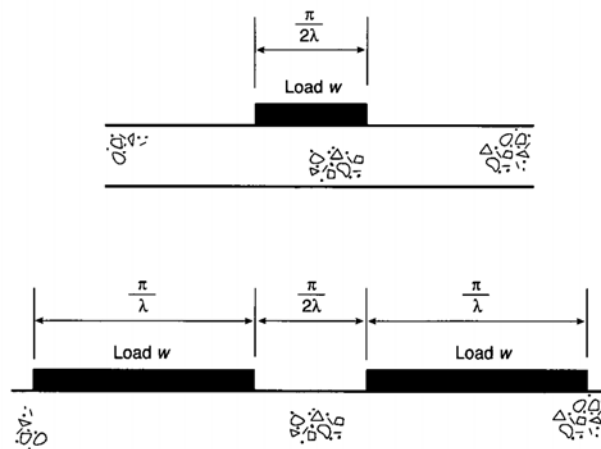

Figure 9.8: Loading patterns for uniformly distributed load, w , causing maximum positive bending moment (upper drawing) and maximum negative bending moment (lower drawing).

the slab locally, though this effect can be reduced or eliminated by back filling with an epoxy resin filler of sufficient strength. If the guide wire is offset from the centre-line of the aisle, an incorrectly filled groove may lead to the bending capacity of the slab at the location of the guide wire being more critical than that mid-way between the loaded areas.

If the position of the loading is well defined, Hetenyi⁽⁵⁵⁾ has shown that the positive bending moment induced under a load of width $2c$ (shown in Figure 9.9(a)) is given by:

$$M_p = \frac{w}{2\lambda^2} (B_{\lambda c}) \quad \text{Eqn 9.20}$$

where

$$B_{\lambda c} = e^{-\lambda c} \text{Sin } \lambda c$$

$$e = 2.7182$$

Hence:

$$w = \frac{2}{(B_{\lambda c})} \lambda^2 M_p \quad \text{Eqn 9.21}$$

At a distance a_1 from the near face of the loaded area, and where b_1 is the distance from the far face, see Figure 9.9 (b), the induced negative moment, M_{n1} , is given by:

$$M_{n1} = \frac{1}{4\lambda^2} (B_{\lambda a_1} - B_{\lambda b_1}) w \quad \text{Eqn 9.22}$$

where

$$B_{\lambda a_1} = e^{-\lambda a_1} \text{Sin } \lambda a_1$$

$$B_{\lambda b_1} = e^{-\lambda b_1} \text{Sin } \lambda b_1$$

If a second load is located close to the first (Figure 9.9 (b)), this will induce an additional bending moment M_{n2} , again determined from Equation 9.22 but with modified values of a and b . Hence w may be determined from the maximum value of $(M_{n1} + M_{n2})$, equating this to the concrete capacity M_n .

As indicated in Section 9.3.2, this is a situation in which differential shrinkage and temperature changes may lead to significant tensile stresses. In the absence of more detailed calculations (see Section 9.12.3) it should be assumed that these stresses are equivalent to 1.5 N/mm^2 and this figure should be deducted from the value of $f_{ctk,fl}$ used in Equation 9.6 to determine M_n .

Examples of the application of the Hetenyi equations for line loads and uniformly distributed loads are given in the worked example for a warehouse floor in Appendix B.

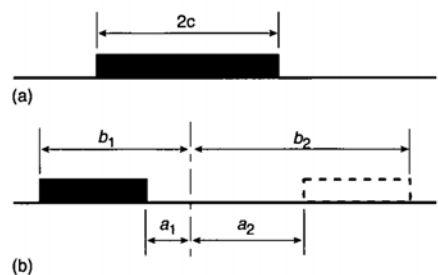

Figure 9.9: Defined areas of uniformly distributed load.

9.10 CALCULATION OF LOAD TRANSFER

For discussion of load transfer by aggregate interlock and steel fibres, see Sections 8.8.2 and 8.8.3.

9.10.1 Load transfer by dowels

This Section provides a simplified treatment of work on mathematical analysis of dowel design, including dowel group action, by Yoder and Witczak⁽⁵⁶⁾, who summarised the work of Friberg⁽⁵⁷⁾ and Bradbury⁽⁵⁸⁾. The following is a simplified treatment of this work applicable to square and round dowels. Figure 9.10 shows a joint opening of x , dowel diameter d_d (or square of side d) and bearing length b , all dimensions in mm.

Effective dowel numbers: Yoder and Witczak⁽⁵⁶⁾ suggested that dowels within a distance of $1.8 l$ either side of the centre-line of the applied load would contribute to transferring the load, where l is the radius of relative stiffness, see Section 9.4.6. The amount of load carried by each dowel was assumed to reduce with distance from the centre-line. For the purposes of this document, it is recommended that the load transfer should be determined from the capacity of the dowels within a distance of $0.9 l$ either side of the centre-line, with all the dowels operating at their full capacity, as given in Table 9.4. (This is equivalent to Yoder and Witczak's recommendations.) The total load transfer will be an absolute capacity in kN, rather than a percentage. Clearly, it should not be taken as being greater than half the applied load. As an example, if the applied load is 120 kN and the dowel capacity within a distance of $0.9 l$ either side of the centre-line is 20 kN, the slab should be checked for its capacity to carry 100 kN.

The shear capacity per dowel, P_{sh} , is given by:

$$P_{sh} = 0.6 f_y A_v / \gamma_s \quad \text{Eqn 9.23}$$

where

f_y = characteristic strength of the steel

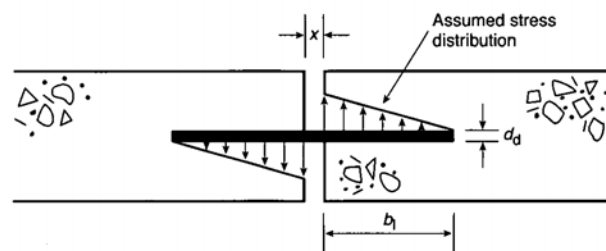

(a) General arrangement

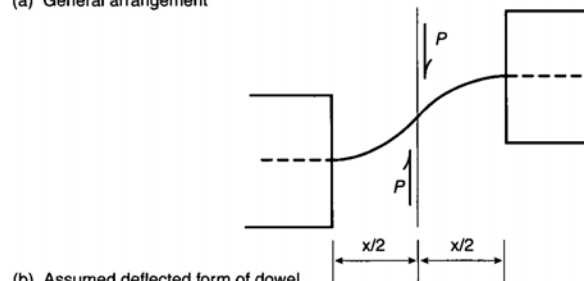

(b) Assumed deflected form of dowel

Figure 9.10: Behaviour of dowels.

A_v = shear area, taken as $0.9 \times$ area of the section ($\pi d^2/4$ for round dowels and d^2 for square bars)

γ_s = partial safety factor for steel (taken as 1.15, see Section 9.6.2).

The **bearing capacity** per dowel, P_{bear} , is given by:

$$P_{\text{bear}} = 0.5f_{\text{cu}}b_1d_d / \gamma_c \quad \text{Eqn 9.24}$$

where

b_1 = effective bearing length, taken as not greater than $8d_d$

d_d = diameter of circular dowel or width of non-circular sections

f_{cu} = characteristic compressive cube strength of the concrete (N/mm^2)

γ_c = partial safety factor for concrete (taken as 1.5, see Section 9.6.2).

The **bending capacity** per dowel, P_{bend} , is a function of the joint opening, x , and is given by:

$$P_{\text{bend}} = (2f_y Z_p) / x \gamma_s \quad \text{Eqn 9.25}$$

where

Z_p = plastic section modulus of the dowel, $d_d^3/4$ for square dowels, and $d_d^3/6$ for round dowels.

When dowels are subjected to **combined shear and bending**, the load-transfer capacity per dowel, P_{app} , is controlled by the following interaction formula:

$$\frac{P_{\text{app}}}{P_{\text{sh}}} + \frac{P_{\text{app}}}{P_{\text{bend}}} \leq 1.4 \quad \text{Eqn 9.26}$$

The **capacities of single dowels** of the types shown in Table 9.4 have been evaluated using Equations 9.23 to 9.25. The following design data have been assumed:

Characteristic tensile strength, steel dowels, f_y 250 N/mm^2

Characteristic compressive strength, concrete, f_{cu} 40 N/mm^2

Modulus of elasticity of steel dowel, E_s 200 kN/mm^2

Shear modulus of steel dowel, G $0.4 E_s$ kN/mm^2

Joint opening, x 5, 10 and 15 mm

Partial safety factor for steel, γ_s 1.15

Partial safety factor for concrete, γ_c 1.5

Example of combined bending and shear: A load transfer of 30 kN per dowel is required at an anticipated maximum joint opening of 15 mm.

Try 20 mm round dowel:

$$(30/36.9) + (30/40.3) = 0.813 + 0.744 = 1.557 > 1.4$$

Hence 20 mm round dowel is not adequate. Try 20 mm square dowel:

$$(30/47.0) + (30/58.0) = 0.638 + 0.517 = 1.155 < 1.4$$

Hence 20 mm square dowel is adequate for the required load transfer.

Bursting forces: The possibility of dowels bursting (punching) out of the concrete has generally been ignored. However, to achieve the maximum load-transfer capacity of dowels in bending, shear and bearing it is necessary to check that bursting does not govern as could be the case in thinner slabs.

A simple approach is to use a modification of the procedure for punching shear given in the draft Eurocode 2, as detailed in Section 9.11. Assuming that the dowel is at the mid-depth of the slab, the critical perimeter for punching should be taken at $2 \times 1/2h = h$ from the dowel (where h is the overall thickness of the slab) and the loaded length should be taken as $8 \times$ the dowel diameter as before. If the dowel spacing is such that the critical perimeters around the individual dowels would overlap, the shear capacity of the slab along a perimeter encompassing all of the dowels should be checked. For heavy loading, longitudinal and transverse reinforcement may be required on each side of the joint.

Table 9.5 gives the maximum load per dowel to avoid bursting (punching) for a range of slab thicknesses and dowel sizes. The loads are based on a plain concrete with $f_{\text{cu}} = 40 \text{ N/mm}^2$. Recent work ⁽⁷⁾ has shown that steel fibres can assist in controlling bursting (see also Section 1.4). However, it appears that this is a function of fibre type and careful interpretation of this research is required.

Table 9.5. Maximum load per dowel (kN) to avoid bursting (punching) of slabs.

Dowel size	Slab depth		
	150 mm	175 mm	200 mm
12 mm round	28.4	36.9	46.6
16 mm round	31.2	40.3	50.4
20 mm round	34.1	43.6	54.2
20 mm square	34.1	43.6	54.2

Table 9.4: Design capacity of single dowels in shear, bearing and bending.

Dowel size	Total dowel length (mm)	P_{sh} (kN)	P_{bear} (kN)	P_{bend} (kN)		
				$x = 5$	$x = 10$	$x = 15$
12 mm round	400	13.3	15.4	26.1	13.1	8.7
16 mm round	400	23.6	27.3	61.9	31.0	20.6
20 mm round	500	36.9	42.7	121.0	60.5	40.3
20 mm square	500	47.0	42.7	173.9	87.0	58.0

The deflection of the dowel, δ_d , can be expressed as:

$$\delta_d = 2 \left[\left(P x^3 / 24 E_s I \right) + (P F / 2 G A) \right] \quad \text{Eqn 9.27}$$

where

- A = cross-sectional area of dowel
- E_s = modulus of elasticity of steel
- F = shear shape factor (6/5 for square dowels and 10/9 for round dowels)
- G = shear modulus of dowel
- I = moment of inertia of dowel = $d_d^4/12$ for square dowels, and $\pi d_d^4/64$ for round dowels
- P = applied load per dowel
- x = joint opening.

For deflection calculations, P represents the service load.

For guidance on limiting deflections at joints, see Sections 4.3 and 4.4.

Using Equation 9.27 to estimate the dowel deflection will give very small values. Table 9.6 shows deflections at various joint openings for a 20 mm round dowel for which the minimum ultimate load capacity in shear is $P_{sh} = 36.9$ kN. Assuming a partial safety factor of 1.2 for loading, then the service load is $36.9/1.2 = 30.7$ kN.

Table 9.6: Typical deflections for 20 mm round dowel.

x (mm)	δ_d (mm)
5	1.57×10^{-3}
10	3.00×10^{-3}
15	6.89×10^{-3}

The overall deflection of the joint will be the sum of the dowel deflection and that of the concrete. The total deflection will generally still be very small.

If an assessment of the total deflection is required, Walker and Holland⁽⁵⁹⁾ have developed a means of estimating the deflection of the concrete assuming the dowel to be a beam on an elastic foundation. Ozbeki *et al.*⁽⁶⁰⁾ have shown that the variables that have a significant effect on joint performance are the dowel-concrete interaction and the modulus of subgrade reaction. Friberg⁽⁵⁷⁾ has adapted work presented by Timoshenko and Lessels⁽⁶¹⁾ giving the deflection of a dowel related to the modulus of dowel support and the relative stiffness of a bar embedded in concrete at the joint face and the maximum bending moment. The Friberg analysis can be extended to calculate dowel group capacity⁽⁵⁶⁾.

9.10.2 Load transfer by fabric

The load-transfer capacity of fabric for commonly used fabric sizes is given in Table 9.7.

9.10.3 Load transfer by proprietary systems

For proprietary systems, guidance on the load-transfer capacity should be obtained from the supplier.

Table 9.7: Values of load-transfer capacity, $P_{app,fab}$, based on Equations 9.23 to 9.26, and using $f_y = 460$ N/mm², $\gamma_s = 1.05$, and $x \geq 2.0$ mm.

BS fabric reference	Bar diameter (mm)	Bar area (mm ²)	Bar centres (mm)	$P_{app,fab}$ (kN/m)
A142	6	28.3	200	13.4
A193	7	38.5	200	18.3
A252	8	50.2	200	23.8
A393	10	78.5	200	37.2

9.11 PUNCHING SHEAR

9.11.1 Introduction

Punching shear capacity is determined in accordance with the draft Eurocode 2 by checking the shear at the face of the contact area and at the critical perimeter distance $2.0d$ (where d is the effective depth) from the face of the contact area, see Figure 9.11. Generally, the latter will control load capacity.

Design codes, such as the draft Eurocode 2, are written on the basis of conventional bar (or fabric) reinforcement and hence do not define an effective depth for fibre-reinforced concrete slabs. However, the effective depth is the distance from the compression face to the centroid of the reinforcement in tension. Following this approach, the effective depth for a fibre-reinforced slab should be taken as $0.75 h$, where h is the overall depth.

The following might be considered a conservative approach as it assumes that the slab carries all the punching load. In most cases, a proportion of the load will be transferred directly to the sub-base but this should not be relied upon.

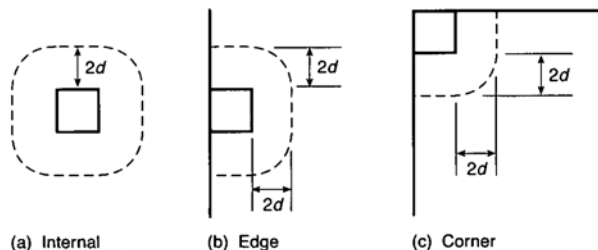

Figure 9.11: Critical perimeters for punching shear for internal, edge and corner loading.

9.11.2 Shear at the face of the loaded area

In accordance with the draft Eurocode 2, irrespective of the amount of any reinforcement in the slab, the shear stress at the face of the contact area should not exceed a value v_{max} given by:

$$v_{max} = 0.5 k_2 f_{cd} \quad \text{Eqn 9.28}$$

where

$$f_{cd} = \text{design concrete compressive strength (cylinder)} \\ = f_{ck} / \gamma_c$$

$k_2 = 0.6 (1 - f_{ck} / 250)$ (note that a different symbol is used in the draft Eurocode)

where

f_{ck} = characteristic concrete compressive strength (cylinder).

Hence, maximum load capacity in punching, $P_{p,max}$, is given by:

$$P_{p,max} = v_{max} u_0 d \quad \text{Eqn 9.29}$$

where

u_0 = length of the perimeter at the face of the loaded area.

9.11.3 Shear on the critical perimeter

The shear stress is checked on the critical shear perimeter at a distance $2d$ from the face of the contact area.

Fabric or bar reinforcement

The average shear stress that can be carried by the concrete on the shear perimeter, $v_{Rd,c}$, is given by:

$$v_{Rd,c} = \frac{0.18}{\gamma_c} k_1 (100 \rho_1 f_{ck})^{1/3} \geq 0.035 k_1^{3/2} f_{ck}^{1/2} \quad \text{Eqn 9.30}$$

where

$$\rho_1 = \sqrt{(\rho_x \rho_y)}$$

ρ_x, ρ_y = percentage of reinforcement by area in the x- and y-directions respectively

$$k_1 = 1 + (200 / d)^{0.5} \leq 2.$$

Thus the slab load capacity, P_p , is given by:

$$P_p = v_{Rd,c} u_1 d \quad \text{Eqn 9.31}$$

where

u_1 = length of the perimeter at a distance $2d$ from the loaded area.

Steel fibre reinforcement

Based on RILEM guidance ⁽⁶²⁾, the presence of steel fibres will increase the design shear capacity over that of the plain concrete by an amount v_f given by:

$$v_f = 0.12 R_{e,3} f_{ctk,fl} \quad \text{Eqn 9.32}$$

where

$R_{e,3}$ = equivalent flexural strength ratio

$f_{ctk,fl}$ = characteristic flexural strength of plain concrete (refer to Table 9.1 and Equation 9.1.)

The draft Eurocode 2 gives a minimum shear capacity of $0.035 k_1^{3/2} f_{ck}^{1/2}$. Thus for steel-fibre-reinforced concrete the slab load capacity, P_p , is given by:

$$P_p = (0.035 k_1^{3/2} f_{ck}^{1/2} + 0.12 R_{e,3} f_{ctk,fl}) u_1 d \quad \text{Eqn 9.33}$$

An example of the estimation of punching shear capacity for a ground-supported slab with steel fibre reinforcement is given in Appendix B.

Synthetic fibre reinforcement

Currently no guidance is available similar to that for steel fibres on the shear capacity of structural synthetic fibre concrete. In the absence of information from the supplier, it should be assumed that the shear capacity is that of plain concrete. Hence, for synthetic fibre concrete the slab load capacity is given by:

$$P_p = (0.035 k_1^{3/2} f_{ck}^{1/2}) u_1 d \quad \text{Eqn 9.34}$$

9.12 CHECKS FOR SERVICEABILITY

9.12.1 Overview

It is normal practice to determine the slab depth using ultimate load procedures for bending and punching shear as described previously (see Sections 9.8 to 9.11). It is then necessary to check the performance of the slab at the serviceability limit state. The primary considerations are deflection, crack control and joint opening. For the serviceability limit state the partial safety factors for materials and actions are taken as unity. Under certain conditions, it may be necessary to increase the slab depth determined from ultimate load procedures in order to satisfy serviceability requirements.

9.12.2 Deflection control

Figure 9.12 shows a typical load–deflection relationship for a ground-supported slab with adequate reinforcement to ensure that sufficient ductility is achieved.

The service load, $P_{SLS} = P_{ULS} / (\gamma_m \gamma_f)$, should be within the portion OA of the load–deflection relationship, that is below the linear limit, P_{LL} . Further, the deflection, δ , should be such that the operation of materials handling equipment is not impeded. (As an illustration, a slab of depth 150 mm, subjected to an internal load, deflects about 1.5 mm at a linear limit of 180 kN.) It has been shown from tests, and from experience, that the values of γ_m and γ_f used in design are such that slabs designed for the ultimate limit state generally perform adequately under service conditions.

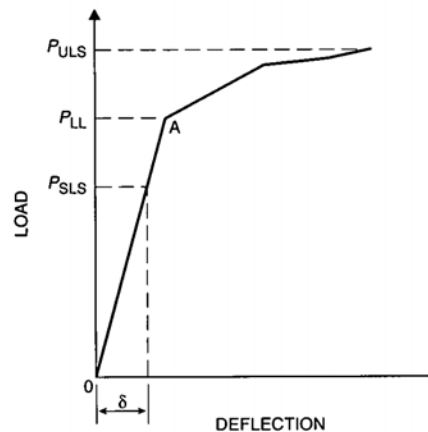

Figure 9.12: Typical load–deflection relationship for steel-fibre-reinforced ground-supported slab.

If required, Westergaard's equations may be used to obtain an approximate quantification of slab deflections under a concentrated load P . The deflection δ may be expressed as:

$$\delta = c \left(\frac{P}{kl^2} \right) \quad \text{Eqn 9.35}$$

where

k = modulus of subgrade reaction

l = radius of relative stiffness

c = deflection coefficient, depending on the position of the load.

For internal and edge loading, the values of c are 0.125 and 0.442 respectively. For corner loading, the values of c are a function of a/l , calculated as $c = [1.1 - 1.24 (a/l)]$, and are given in Table 9.8. The influence of k on deflections of a typical slab ($a = 56$ mm, $h = 150$ mm, $E_{cm} = 33 \times 10^3$ N/mm²) under a point load of 60 kN is shown in Table 9.9.

Table 9.8: Values of deflection coefficient c for corner loading.

a/l	0.050	0.075	0.100	0.125	0.150	0.175	0.200
c	1.04	1.01	0.98	0.95	0.92	0.89	0.86

The influence of creep on deflection under long-term loading can be estimated by adjusting the value of l , see Section 9.4.6. The modulus of elasticity of the concrete will be influenced by creep under sustained load and thus in the long term the effective modulus of concrete can be expressed approximately by:

$$E_{cm(t)} = E_{cm} / (1 + \phi) \quad \text{Eqn 9.36}$$

where

ϕ = creep factor.

The creep factor is dependent on a number of factors. In BS 8110⁽¹⁵⁾ the relationships between relative humidity, age at loading, effective thickness and ϕ are expressed in graphical form. The draft Eurocode 2⁽¹⁶⁾ adopts a similar procedure and includes the grade of concrete and type of cement (slow, normal and rapid hardening). A value of $\phi = 2.0$ is recommended for use in the following sections.

Reference to the Westergaard deflection equations indicates that deflection is inversely proportional to kl^2 . The value of l will reduce as the value of E_{cm} decreases. See Section 9.4.6.

It should be noted from Table 9.9 that the free-edge and corner deflections are significantly greater than the internal values. However, these deflections will be reduced where load transfer is provided.

9.12.3 Movements

Introduction

Three types of intrinsic (inherent) movement can occur in concrete slabs:

Table 9.9: Influence of k on deflection of typical slab under a point load of 60 kN.

k (N/mm ³)	l (mm)	P/kl^2 (mm)	Deflections (mm)		
			Internal	Free edge	Free corner
0.02	834	4.31	0.54	1.90	4.38
0.04	701	3.05	0.38	1.34	3.05
0.06	634	2.49	0.31	1.10	2.47
0.08	590	2.15	0.27	0.95	2.11
0.10	558	1.93	0.24	0.85	1.88

1. plastic shrinkage and settlement
2. thermal, due to both early contraction and seasonal/diurnal temperature changes
3. long-term drying shrinkage.

Chapters 10 and 11 provide further discussion of shrinkage and related materials properties.

The periods in which these movements take place^(17, 20) are given in broad terms in Table 9.10.

Table 9.10: Typical periods over which movements occur.

Type of movement	Period
Plastic	First few hours after casting
Early thermal contraction	One to two days after casting
Seasonal/diurnal temperature changes	Annually/daily although the first annual cycle is likely to be the most critical
Drying shrinkage	Several months or years after casting

If these movements are restrained, stresses will be induced. Cracks will occur when the tensile strain to which concrete is subjected exceeds its tensile strain capacity. The tensile strain capacity of concrete varies with age and with the rate of application of strain. The design approach is intended to avoid the formation of cracks on the top surface of the slab.

Plastic shrinkage

Plastic shrinkage occurs in the first few hours after placement of the concrete. It should be minimised by the selection of appropriate materials and mix design and by minimising exposure of the young concrete to extreme drying conditions. Plastic shrinkage is generally not perceived to be a problem for industrial floors because any cracks that form are closed by the finishing operations. However, subsequent grinding or shot blasting of floors has demonstrated that cracks may still exist below the surface.

Thermal effects

The hydration of concrete results in the slab hardening at a higher temperature than the ambient environment. This leads

to an irreversible thermal contraction, which occurs from around 14 hours to one week after construction as the heat generated is lost to the environment. Temperature drops of more than 10°C are common during this period, resulting in a contraction strain of around 100×10^{-6} .

Reversible movements are also caused by the influence of climatic changes on industrial floors. The daily temperature changes are small and have little effect on industrial floors, as they are not exposed to direct sunlight. However, seasonal temperature changes can cause significant movements. As many industrial floors are in unheated buildings, the annual change can be greater than 15°C, corresponding to an unrestrained strain of around 150×10^{-6} .

Long-term drying shrinkage

Long-term moisture loss from hardened concrete results in drying shrinkage. This process can last many years: it depends on the environment and the properties of the concrete. After being exposed to air for three months, the slab may have undergone only 30% of its long-term drying shrinkage. Restraint can lead to the development of cracks. For a well-designed concrete, long-term shrinkage strains are in the range 400 to 600×10^{-6} mm. For a 6 m slab these are equivalent to an overall unrestrained shortening of 2.4 to 3.6 mm, but this will be mitigated by restraint and creep: and it is estimated that the actual shortening will be approximately half these values.

A key factor influencing the drying shrinkage of concrete is the water content. The more water that is available to evaporate from the concrete, the greater the tendency to shrink on drying. Long-term drying shrinkage can be minimised by the selection of appropriate materials and mix design, see Section 10.3.2.

Shrinkage restraint stresses

If the slab is fully restrained, the shrinkage stress $f_{sh,full}$ can be expressed as:

$$f_{sh} = E_{cm} \epsilon_{sh} \quad \text{Eqn 9.37}$$

where

E_{cm} = secant modulus of elasticity of the concrete

ϵ_{sh} = long-term shrinkage strain.

As the shrinkage is time-dependent, it will be mitigated by creep and so the value of E_{cm} , given in Table 9.1, should be modified in line with Equation 9.37, taking $\phi = 2$. Thus E_{cm} is replaced by $E_{cm(t)} = E_{cm}/3$.

The factored shrinkage stress given by

$$f_{sh} = E_{cm(t)} \epsilon_{sh} \quad \text{Eqn 9.38}$$

will give values that exceed the tensile capacity of plain concrete and thus it is necessary to provide some means of reducing shrinkage restraint. This is commonly achieved by means of a slip membrane separating the underside of the slab from the sub-base.

Coefficients of friction, μ , for different slip media have been evaluated by Timms⁽⁶³⁾ and vary from less than 1.0 to more

than 2.5. The conventional approach to evaluating the shrinkage restraint force is to assume it reaches a maximum value midway between free-movement joints. However, it has been found that this tends to significantly over-estimate the stresses. Table 3.3 in BS 8110-2⁽¹⁵⁾ gives *Values of restraint recorded in various structures*. Although this is for early thermal movements, the approach should be equally valid for shrinkage. For 'massive pour cast on to existing blinding' this recommends a restraint factor between 0.1 and 0.2 (where full restraint is taken as 1.0).

For this report a restraint factor of 0.2 is recommended. Hence the estimated stress induced in the slab by the restraint to shrinkage, f_{sh} is given by:

$$f_{sh} = 0.2 E_{cm(t)} \epsilon_{sh} \quad \text{Eqn 9.39}$$

Taking ϵ_{sh} as 500×10^{-6}

$$f_{sh} = 0.2 \times 11 \times 10^3 \times 500 \times 10^{-6} = 1.1 \text{ N/mm}^2$$

Curling

Curling is the result of differential shrinkage between the top and bottom of the slab. Moisture loss from a slab is primarily in one direction towards the surface, resulting in a moisture gradient that causes the slab to curl. It has not been current UK practice to quantify curling-induced stresses. However, the bending stress, f_{cur} , may be expressed as:

$$f_{cur} = \left(\frac{1}{2} \right) E_{cm(t)} \left(\frac{\Delta \epsilon}{1 - \nu} \right) \quad \text{Eqn 9.40}$$

where

$E_{cm(t)}$ = modulus of elasticity of concrete modified due to creep

ν = Poisson's ratio (= 0.2)

$\Delta \epsilon$ = differential strain between the top and bottom of the slab, typically taken as $(1.5 - 2.0) \times 10^{-6}$ per mm of slab thickness.

The value of $E_{cm} = 33 \times 10^3 \text{ N/mm}^2$ is modified to $E_{cm(t)}$ by the factor $[1/(1 + \phi)]$. A creep factor ϕ of 2.0 is assumed, giving $E_{cm(t)} = 11 \times 10^3 \text{ N/mm}^2$.

Assume the lower value of $\Delta \epsilon$, i.e.

$$\Delta \epsilon = 1.5 \times 10^{-6} \times 175$$

Hence the estimated bending stress induced by curling,

$$f_{cur} = \frac{1}{2} (11 \times 10^3) (1.5 \times 10^{-6} \times 175) / (1 - 0.2) \\ = 1.8 \text{ N/mm}^2$$

Recommendations for dealing with restraint stresses

Recent research⁽⁸⁾ has shown that shrinkage-induced stresses should be considered in design, particularly when significant hogging moments occur due to imposed actions, such as uniformly distributed loads (e.g. block stacking), see Section 9.9.5. However, the interaction between the shrinkage-induced stresses and those due to loading is not well understood. The relative magnitude of the former will be influenced by environmental conditions and the time of loading.

Hence, in the absence of more detailed calculations, this report recommends that the net effect of the various restrained strains may be taken as a flexural tensile stress of 1.5 N/mm² and consideration should be given to deducting this from the flexural tensile strength of the concrete when

calculating the hogging moment capacity in critical areas. The above conditions could also arise in areas of heavy racking which may be additionally analysed as being equivalent to block stacking.

PART THREE

CONCRETE PERFORMANCE AND COMPONENT MATERIALS

The chapters in this Part consider the essential performance characteristics of concrete for floors and the common materials used in such concrete. Reinforcement and the structural effect of reinforcements such as fibres, steel reinforcement bar and steel fabric are not considered here, but in Chapter 7.

The principles of specifying, selecting, producing and using concrete in industrial floors are not fundamentally different from those for concrete in numerous other applications. However, the requirements for concrete for floors are quite demanding, if construction is to be successful, and the floor is to meet its performance criteria, such as abrasion resistance, surface regularity and structural integrity. Satisfactory performance of floors is particularly dependent on adequate curing.

This Part will provide basic guidance for those responsible for specifying, producing and placing concrete for floors.

CONTENTS

10	CONCRETE PERFORMANCE	11	CONCRETE COMPONENTS
10.1	Specification considerations	11.1	Cement
10.2	Strength and related characteristics	11.2	Aggregates
10.3	Shrinkage	11.3	Admixtures
10.4	Mix design for placing and finishing	11.4	Dry shake finishes
10.5	Abrasion resistance	11.5	Steel fibres
10.6	Chemical resistance	11.6	Synthetic fibres

10 CONCRETE PERFORMANCE

Note: At the time of publication of this report (2003), many British Standards for concrete and its constituent materials are being developed into European Standards, and many long-established Standards, whose reference numbers have become familiar, are being replaced. It is not possible to provide a comprehensive list of all the changes that are expected, and so readers should ensure that they refer to the standards that are current at the time. Of particular importance are the replacement of the main standard for concrete BS 5328⁽⁶⁴⁾ by BS EN 206-1⁽⁶⁵⁾ and BS 8500⁽⁶⁶⁾, which is due to take place in December 2003, and of BS 8110, the code of practice for structural concrete, by Eurocode 2; the date at which this will happen is not known at present. In BS 8500, compressive strength of concrete is specified by 'strength class' whereas BS 5328 uses the term 'strength grade'. Otherwise, for practical purposes, there is no change in the method of specifying cube strength.

10.1 SPECIFICATION CONSIDERATIONS

Concrete for floors should be designed for that specific purpose. The mix design considerations will need to address the performance objectives described in this chapter. It may be necessary to make compromises to take into account potentially opposing performance objectives. For example, increasing strength through the use of higher cement content may have the potentially undesirable effect of increasing shrinkage.

The overall objective is to produce concrete of adequate performance using local materials where possible. The important performance factors to be considered are:

- strength and related characteristics
- placing and finishing needs
- shrinkage
- durability
 - against abrasion
 - against chemicals.

Chapter 11 considers the characteristics of the constituent materials that are needed to meet these performance aspects.

10.2 STRENGTH AND RELATED CHARACTERISTICS

10.2.1 Compressive and flexural strength

The standard method of specifying concrete for most structural applications is by characteristic cube strength. However, the important strength parameter for ground-supported slabs is flexural tensile strength.

Flexural tensile testing of concrete is not common and in the draft Eurocode 2⁽¹⁶⁾ fixed relationships, based on empirical data, are used to calculate flexural tensile strength. See Section 9.4.1, Table 9.1 and Equation 9.1. Any departure from these relationships and the data given would require test data to establish the flexural tensile strength of a proposed concrete mix.

10.2.2 Ductility of fibre-reinforced concrete

Steel fibres are commonly used in concrete for industrial floors and the resultant composite concrete can have considerable ductility, often termed 'toughness'. Ductility is dependent on fibre type, dosage, tensile strength and anchorage mechanism. It should be pointed out that steel fibres, used at practical dosages, will not increase post-first-crack flexural strength.

Structural synthetic fibres have been developed that can also enhance ductility⁽⁴⁷⁾. These fibres are significantly larger than the monofilament and fibrillated polypropylene fibres in common use and are used at much higher dosages. As with steel fibres, data should be sought from suppliers on the performance of such fibres in practice.

Information on testing for ductility characteristics can be found in Chapter 7.

10.2.3 Maturity of concrete in cold store floors

Concrete floors are used in cold stores with temperatures as low as -40°C . Fully matured concrete performs well at constant low temperatures. Immature concrete with a compressive strength of less than 5 N/mm^2 may be damaged by freezing and immature concrete with strength higher than 5 N/mm^2 may have its strength development curtailed by too early a reduction in temperature. It is therefore essential that cold store slabs are allowed to mature for at least 28 days or that other steps are taken to ensure adequate in-situ strength, before the temperature is drawn down.

Concrete not subject to wetting will resist both continued exposure to temperatures below freezing and freeze-thaw cycles. Therefore there is generally no need to consider enhanced performance.

10.3 SHRINKAGE

10.3.1 Introduction

Shrinkage is a reduction in size or volume; for concrete floors, several generic types of shrinkage are of concern. In order of decreasing importance, they are:

- drying shrinkage

- early thermal contraction
- crazing
- plastic shrinkage.

Causes of shrinkage and strategies to minimise its effect are discussed in this section.

In certain circumstances, all these forms of shrinkage can lead to cracking, although drying shrinkage is often the most relevant to concrete floor slabs. Recent research indicates that thermal contraction is more significant than previously thought⁽⁶⁵⁾.

Although curing is of great importance in achieving a durable concrete floor, it does not reduce shrinkage. A floor will eventually dry and shrink by an amount that is almost independent of when that drying begins. However, curing has a significant beneficial effect on tensile strain capacity and it is for this reason that good curing may reduce the risk of cracking⁽²⁰⁾.

10.3.2 Drying shrinkage

All concrete shrinks as the water in the concrete evaporates to the atmosphere though the shrinkage mechanism is not fully understood⁽⁶⁷⁾. Concrete floors usually lose more water from the upper surface, resulting in non-uniform shrinkage and curling. Any steps taken to reduce shrinkage will reduce curling.

The key to minimising the drying shrinkage of concrete is to keep the water content as low as possible. Cement paste is usually the only component of concrete that undergoes significant shrinkage, but some aggregates (such as those from the Midland Valley of Scotland⁽⁶⁸⁾) are known to have high levels of drying shrinkage. If the properties of aggregates are not known, it is recommended that data is obtained using the test in BS EN 1367-4⁽⁶⁹⁾.

The combined grading of the coarse and fine aggregates should be adjusted to minimise the water demand. This requires an overall grading that provides optimum packing and the minimum effective surface area. The volume of cement paste should be kept to a minimum (consistent with strength requirements) thus increasing the relative volume of dimensionally stable aggregate. The largest available size of aggregate should be used, consistent with the thickness of the slab. In practice, this is a nominally 20 mm aggregate in the UK.

The main factors influencing drying shrinkage are the volume of cement paste and its water content. High cement contents should be avoided and the water content should be as low as possible, consistent with the specified maximum free-water/cement ratio and the practicalities of placing and finishing. The maximum water/cement ratio should be 0.55. The use of water-reducing admixtures (see Section 11.3) is

strongly recommended. Shrinkage-reducing admixtures can also be used to further reduce concrete drying shrinkage.

When specifying concrete for floors:

- Do not specify a higher strength than necessary.
- Do not exceed a water/cement ratio of 0.55*.
- Consider water-reducing admixtures.
- Consider shrinkage-reducing admixtures.
- Specify the largest appropriate size of coarse aggregate (usually 20 mm).
- Do not specify a high minimum cement content.

10.3.3 Early thermal contraction

The hydration of Portland cement (and to a lesser extent other cementitious materials) generates heat. If the rate of heat generated by cement hydration is greater than the loss of heat from the concrete surfaces, the concrete will expand. Conversely, as the rate reduces with time, there will be net cooling and the concrete will contract.

Thermal contraction has only been considered to be important for massive concrete elements and has generally been ignored for floors. Work at Loughborough University⁽⁸⁾ has demonstrated that it can also affect concrete floors. In particular, it is thought that early thermal contraction is the mechanism by which cracks beneath sawn joints form and the probable cause of early, unplanned, mid-panel cracking if these joints are cut too late.

Early thermal contraction can be reduced by minimising heat generated. Cement content should be kept to a minimum (consistent with strength requirements) and lower heat cements (such as those containing pfa or ggbs) should be used, particularly in hot weather. Admixtures can be used to reduce the water content and thereby the cement content (while maintaining strength and workability).

Where they are available and economically viable, the use of aggregates with low coefficients of thermal expansion (see Table 10.1) such as non-siliceous limestone rather than quartzite will reduce the magnitude of thermal movement. In

Table 10.1: Approximate coefficient of linear thermal expansion of concrete made with various aggregates.

Aggregate	Coefficient of linear thermal expansion ($\times 10^{-6}$ per $^{\circ}\text{C}$)
Chert	13.5
Quartzite	12
Sandstone, quartz	11.5
Siliceous limestone	11
Granite, dolomite, basalt	10
Limestone	9

* In some areas of the UK, local aggregates may have a high water demand. These will generally require the use of water-reducing admixtures to ensure the required workability and strength can be achieved without the use of undesirably high water or cement contents. For aggregates that produce concrete with a low 'ceiling strength', it may be necessary to reduce the design strength requirement but care should be taken to ensure other specification requirements such as maximum water/cement ratio and resistance to abrasion can be achieved.

many cases, this will also increase the strain capacity of the concrete, thus increasing its resistance to cracking^(70, 71).

In hot weather, consideration should be given to producing and placing concrete in the coolest part of the day and when concrete materials are at their coolest.

10.3.4 Crazeing

Crazeing is the result of differential shrinkage of the surface zone of a concrete slab relative to the bulk and is a common feature of power-finished floors. The topic is discussed in Section 5.6. Experience suggests that, despite its appearance, crazeing generally has no effect on the performance of a floor surface.

10.3.5 Plastic shrinkage

As the name implies, plastic shrinkage occurs whilst the concrete is still plastic, i.e. before it hardens. The main cause of plastic shrinkage is rapid drying of the exposed concrete surface. If the rate of evaporation from the surface exceeds the rate at which bleed water rises to the surface, net shrinkage will occur (with the possibility of subsequent cracking).

As the main cause of plastic shrinkage is rapid drying of the concrete surface, materials and mix design normally have a limited influence. However, highly cohesive concretes with very low bleed characteristics are particularly susceptible to plastic shrinkage cracking. Concretes with low water/cement ratios or containing fine additions such as silica fume or metakaolin may be at higher risk, particularly if early protection is inadequate.

Loss of moisture from the surface can be reduced by protecting the surface from drying air flows, particularly in warm weather. Protection from wind and sun is essential and floors should be constructed after the walls and roof are in position and openings are sealed. See Chapter 12.

The use of set-retarding admixtures will extend the time during which the concrete is susceptible to plastic shrinkage.

Curing is the aspect of floor construction that has the greatest influence over plastic shrinkage (and associated plastic cracking). Effective early curing limits evaporation from the concrete surface during the early stages of setting and hardening, when the tensile strain capacity of the concrete is low. However, there are often practical difficulties in applying curing measures early enough to prevent plastic shrinkage cracking completely.

Power finishing usually closes up plastic cracks although not necessarily to full depth.

10.4 MIX DESIGN FOR PLACING AND FINISHING

Concrete for floors must be workable enough to suit the method of laying. In BS EN 206-1⁽⁶⁵⁾ and BS 8500⁽⁶⁶⁾, workability is termed 'consistence', although the term workability is still recognised and is used here. Workability can be

measured by several established methods, including slump and flow table spread. Slump should be measured in accordance with BS EN 12350-2⁽⁷²⁾. For manually placed concrete a minimum slump of 75 mm (slump class S2) is recommended, while for mechanically placed concrete a target slump of up to 150 mm (slump class S3) is typical. There is no practical benefit in specifying a higher slump.

Mix design should aim to create a homogenous and moderately cohesive concrete that will not segregate when being compacted and finished. Excessively cohesive concrete can be difficult to place, compact and finish. Excessive bleeding should be avoided but some limited bleed water is required to assist with the formation of a surface mortar layer that can be levelled and closed by the power-finishing process. Where dry shake finishes are used, sufficient water is required at the surface for hydration of the cement component of the material.

Aggregate content should be maximised by using an overall aggregate grading that provides the optimum packing and the minimum effective surface area. In practice, there may be limitations on the aggregate gradings available, see Section 11.2. However, it is important to have consistent gradings.

Where a dry shake finish is to be used, fine aggregate contents of the base concrete may be reduced marginally as the dry shake will provide the closed finish. This may be beneficial in increasing workability for a given water content.

High cement content concretes (above 400 kg/m³) are likely to be excessively cohesive and may lead to power-finishing problems particularly in warm weather.

Allowance should be made for fibres. Steel fibres and synthetic structural fibres will reduce workability by about 25 mm. The specified workability should take account of this, particularly when the steel fibres are to be added on site.

Admixtures are useful in increasing workability for a given water content and either shortening or lengthening workability retention times, see Section 11.3.

After batching, the designed workability can reduce as a result of absorption by the aggregates and by evaporation. Delays in the arrival of ready-mixed concrete trucks and warm weather will both increase these effects. A practical way of dealing with this is for the concrete producer and contractor to make provision for the workability to be adjusted under controlled conditions on site. Water additions should be supervised by a competent technician and should be limited to that required to increase the workability to that originally specified. The procedure should ensure that the maximum specified water/cement ratio or the water/cement ratio required for the specified strength, whichever is the controlling value, is not exceeded. When water is added on site, the concrete should be adequately re-mixed. Site records of water additions and final workability should be kept.

The processes for finishing concrete floors (floating, trowelling, etc.) are particularly susceptible to changes in

workability and setting characteristics of concrete. Therefore, avoiding variability in these aspects of performance should be a high priority. For successful laying and finishing of floor slabs it is essential that concrete is well mixed and that workability is consistent within and between batches. Variations in properties of adjacent areas of concrete can cause problems in maintaining the working face and avoiding cold joints. Adjacent areas of concrete at differing stages of stiffening and hardening lead to problems with levels and the smearing of wet mortar paste over hardened areas.

10.5 ABRASION RESISTANCE

Achieving adequate abrasion resistance of a concrete floor depends primarily on effective use of power trowels on the concrete as it sets and, to a lesser extent, on the fine aggregate and cement used in the concrete. Fine aggregate in the surface zone can be either present in the bulk concrete used for the floor or a constituent of a dry shake finish applied to the surface.

The finishing process, in particular the power trowelling, is a skilled activity that should take into account the ambient conditions. Achieving appropriate abrasion resistance and other surface characteristics requires careful timing and control. Although power trowelling, and in particular repeated power trowelling, is a significant factor in developing abrasion resistance, excessive repetitions of the process do not necessarily further enhance performance and can adversely affect the appearance.

The surface of most industrial floors will remain durable for the life of the installation. The coarse aggregate will not be exposed by normal wear and consequently does not contribute to the performance of the surface. In floors subject to extreme wear such as in metal working, and where the floor surface is expected to be worn away, the coarse aggregate may be more important, see Section 11.2.

Fine aggregate will be present in a floor surface and so should not include any soft, friable materials, see Section 11.2.

To improve abrasion resistance of direct finished concrete, BS 8204-2: 2002⁽¹⁰⁾ recommends the use of higher minimum cement contents and strength classes. For floors in distribution and warehouse facilities, where power-finishing is the norm, a lower cement content is considered desirable to reduce shrinkage. BS 8204-2⁽¹⁰⁾ covers a wide range of wearing surfaces and construction practice and so adopts a more conservative approach. Current thinking places greater significance on the role of water/cement ratio⁽⁷³⁾ on the performance of concrete in general and identifies that there are upper limits on cement content, beyond which performance is not increased. This has also been confirmed with specific reference to power-finished floors where the finishing process 'densifies' and reduces the effective water/cement ratio of the surface zone of the concrete^(9,74). This approach is adopted in BS 8500⁽⁶⁶⁾, in which designated concretes have the same strength classes and water/cement ratios as in BS 5328 but lower minimum cement contents.

Cement contents above about 360 kg/m³ are unlikely to improve the abrasion resistance of power-finished floors. It is, however, very important to ensure that water/cement ratios do not exceed 0.55. A typical concrete for flooring of compressive strength class C28/35 (grade C35) or C32/40 (grade C40), with water/cement ratio of 0.55 and minimum cement content of 325 kg/m³, will have adequate abrasion resistance in most power-trowelled floors, provided certain restrictions on the fine aggregate are observed (see Section 11.2), and the concrete is adequately cured.

Where enhanced abrasion resistance is required, the use of dry shake finishes can be considered, see Section 11.4. These can be beneficial because they may have an optimally graded aggregate or because metallic aggregates are used or both. However, aggregates used in some dry shake finishes may give no better performance than the aggregate in the base concrete.

Effective curing is very important in creating abrasion resistance. This is typically done by spraying resin-based curing compounds on the surface as soon as practicable after the finishing process. During the finishing process it is important to minimise surface drying. One of the key factors affecting drying is air movement across the concrete surface and therefore buildings should be totally enclosed before the floor is constructed. See Chapter 12.

The factors affecting abrasion resistance are summarised in Table 10.2. It is not considered appropriate to give prescriptive advice on achieving the performance classes in BS 8204-2, see Table 5.1. Specialist flooring contractors and material suppliers should be consulted for advice.

Abrasion resistance develops over time, so even if a floor has gained enough strength to allow it to be loaded, it may not have developed adequate abrasion resistance. This should be considered where construction programmes are very short, see Section 12.3.

Testing for abrasion resistance

A test method for assessing the abrasion resistance of floors is described in BS 8204-2: 2002⁽¹⁰⁾.

Problems of inadequate abrasion resistance are not common and experience suggests that floors do not need to be, and in practice are not, routinely tested for compliance. If a floor is to be tested, it should be noted that resin-based curing compounds create a layer or 'skin' on the surface that can be impenetrable to the abrasion test machine and can cause misleading results⁽⁷⁵⁾.

Some curing compounds are also described as surface hardeners or surface-penetrating sealers and may have long-term effects on the abrasion resistance of concrete. Similar products are used to improve floors with inadequate abrasion resistance.

10.6 CHEMICAL RESISTANCE

Any agent that attacks hydrated cement will ultimately damage a concrete floor surface if it stays in contact with the

Table 10.2: Factors affecting abrasion resistance of concrete floors.

Factor	Effect
Power finishing	Power finishing and in particular repeated power trowelling is a significant factor in creating abrasion resistance, however, excessive repetitions of the process do not necessarily further enhance performance.
Curing	Prompt and efficient curing is essential in order to retain sufficient water in the surface zone to complete hydration and the development of concrete strength at and close to the surface.
Cement content	Cement content should not be less than 325 kg/m ³ . Cement contents above 360 kg/m ³ are unlikely to enhance abrasion resistance.
Water/cement ratio	Water/cement ratio is of great importance. It should not exceed 0.55. Reducing to 0.50 is likely to increase abrasion resistance but lowering further is unlikely to give further enhancement.
Aggregates	Coarse aggregate usually has no direct effect on abrasion resistance, except in floors in very aggressive environments where the surface is expected to be worn away. Coarse and fine aggregates should not contain soft or friable materials.
Dry shake finishes ⁽¹⁾	Classifications AR1 ⁽²⁾ and Special ⁽²⁾ are likely to require the use of a dry shake finish. Classification AR2 ⁽²⁾ can often be achieved without a dry shake finish subject to good control in materials and finishing.

Notes:

[1] See Section 11.4 for information on the application of dry shake finishes.

[2] See Table 5.1.

floor for long enough. Frequent cleaning to remove aggressive agents will reduce deterioration, but repeated cycles of spillage and cleaning will cause long-term surface damage. For information on aggressive agents see Section 5.3.

The ability of a floor to resist chemical attack depends on the quality of the surface zone, which is about 2 mm thick. Most industrial floors are finished with powered equipment; the factors that affect chemical resistance are similar to those that influence abrasion resistance. Durability is enhanced by the process of densification of the surface through repeated power trowelling. This process intimately compacts the particles near the surface and reduces the pores or voids, thereby reducing the permeability of the surface.

In floors exposed to acids, the quality of the finished concrete is more important than the type of cement or

aggregate used. However, acids react with the hydration products of Portland cement, particularly calcium hydroxide, and so high cement contents are not necessarily beneficial. Cement contents in the range 325 to 360 kg/m³ should be used. The quality of the concrete is a function of the water/cement ratio, which should not exceed 0.55. Lowering the water/cement ratio will improve the chemical resistance but such reductions must be compatible with placing and finishing requirements. Additions such as pfa, ggbs, microsilica or metakaolin are potentially beneficial. Concretes containing microsilica or metakaolin need special care when placing, see Section 11.1.

Where chemical attack is likely, consideration should also be given to protecting the floor with a chemically resistant material or system able to resist the action of the particular aggressive agent.

11 CONCRETE COMPONENTS

11.1 CEMENT

11.1.1 Common cements and combinations

Most former British Standards for cement will have been withdrawn by April 2003. After that date Portland and other manufactured cements and combinations with pulverised-fuel ash (pfa), ground granulated blastfurnace slag (ggbS), silica fume or pozzolanic materials such as metakaolin will be primarily specified with reference to BS EN 197-1⁽⁷⁶⁾ and BS 8500⁽⁶⁶⁾. Combinations are blended at the concrete production plant in accordance with standardized procedures. Cements and combinations in common use are shown in Table 11.1.

11.1.2 Choice of cement/cement combination

The choice of the most appropriate type of cement will be dictated by the strength requirements for the floor and the

constraints of finishing. A summary of the relevant properties of cements and combinations commonly used in floors is given in Table 11.1.

Different cement types and/or combinations give differing concrete setting characteristics, which are sensitive to temperature. Careful choice can therefore beneficially affect the finishing characteristics of concrete across a range of ambient conditions.

The importance of curing

All the cements and combinations described below require effective curing to develop optimum properties in the hardened concrete. Abrasion resistance is particularly sensitive to the early drying of the surface that may occur if curing is inadequate. The early strength development of concrete containing pfa or ggbS is slower in colder weather,

Table 11.1: Effects of different cements and combinations on concrete properties^[1].

Concrete property	Cement/cement combination designation				
	CEM I 42.5	II A-L and II A-LL	II B-V	II-S or III A	II A-D
Standard level of addition	–		6–35% pfa ^[2]	6–65% ggbS ^[2]	Up to 10% silica fume
7/28 day strength	Approx. 80%	Approx. 80%	Approx. 80%	60–80%	Approx. 80%
Workability (relative to CEM I 42.5)	–	Similar	Reduced water demand for given workability	Similar	Increased water demand, superplasticisers always used
Cohesiveness (relative to CEM I 42.5)	–	Reduced bleed	Reduced bleed rate, longer bleed time	Can bleed more than CEM I	Very cohesive No bleeding
Setting time (relative to CEM I 42.5)	–	Similar	Increased. May be significantly extended in cold weather	Slightly longer. May increase significantly at lower temperatures and higher replacement levels	Reduced slightly
Heat of hydration (relative to CEM I 42.5)	–	Similar	Reduced	Reduced	Similar
Curing requirements	All cements require adequate curing to develop abrasion resistance.				Prompt early curing required to prevent plastic cracking
Other comments ^[3]	–	–	Extended finishing window in hot weather. Can delay finishing in cold weather	Increased cohesiveness can lead to stickiness and problems with finishing	

Notes

[1] Information based on Concrete Society Technical Reports 40⁽⁷⁷⁾ and 41⁽⁷⁸⁾.

[2] The standard for manufactured cement (BS EN 197-1)⁽⁷⁶⁾ permits maximum contents of pfa and ggbS of 35% and 65%, respectively. However, it is recommended that, in normal circumstances for floors, the amounts of pfa and ggbS in combinations with Portland cement should be limited to 30% and 50%, respectively. Required levels of addition should be specified.

[3] There is little experience of using metakaolin in floors but addition levels of 10–15% of total combination content are typical in other uses.

so proper curing is important to prevent moisture loss, which may result in surface dusting and poorer abrasion resistance. It is therefore important to apply appropriate curing techniques as soon as practical after finishing is completed.

11.1.3 Expansive cements

Expansive cements have been used in the USA for some years – see ACI 223⁽⁷⁹⁾. These are based on calcium sulfo-aluminates which, when blended with Portland cement and a source of sulfate (usually ground anhydrite), hydrate to form expansive calcium sulfo-aluminate hydrates (i.e. ettringite). These types of cement are not covered by British or European standards but are described in ASTM C845-96⁽⁸⁰⁾. Thorough understanding is needed of these specialist materials before their use can be considered. Reference should be made to ACI 223, and manufacturers of expansive cements consulted for further information.

11.2 AGGREGATES

11.2.1 Introduction

Aggregates comprise typically 70% of the volume of concrete. For environmental and economic reasons, local aggregates should be used where possible. Aggregates for use in concrete floors should conform to BS 882⁽⁸¹⁾ and BS EN 12620⁽⁸²⁾. Recycled aggregates should only be used with extreme care as levels of low-density materials and impurities may be unacceptable.

Fine aggregate (sand) gradings should conform to grades C, M or F of Table 4 of BS 882: 1992⁽⁸¹⁾. Fine aggregates with gradings at the coarse end of grade C or the fine end of grade F should be avoided. If crushed rock sand is used, either on its own or in combination with other sands, the proportion of the combined sand by mass passing the 75 µm sieve should not exceed 9%. See Table 6 of BS 882 and BS EN 12620: 2002⁽⁸²⁾.

Aggregates should be free from impurities such as lignite that may affect the integrity or appearance of the finished surface of a floor. It may not be possible to eliminate impurities entirely but if there are concerns about potential impurities in an aggregate source, the contractor should seek assurances from the concrete producer about procedures adopted to minimise this risk. Information on the history of use of sources should be sought. Information on dealing with surface defects can be found in Chapter 5. See also Ref. 23.

11.2.2 Mechanical performance

Abrasion resistance

In most floors, coarse aggregates have no direct influence on the abrasion resistance of the surface, and so all normal concreting aggregates are suitable. For floors in exceptionally aggressive environments where the surface of the floor is likely to be worn away, the mechanical properties of the coarse aggregate are important and the 10% fines value should not be less than 150 kN.

BS EN 12620⁽⁸²⁾, which will be adopted from December 2003, has adopted a classification system based on the Los Angeles test. There is no direct correlation between this test and the 10% fines test. A maximum Los Angeles coefficient of 40 is recommended for aggregate for normal floors. For floors in exceptionally aggressive environments, it may be appropriate to specify a lower value of 30 or 35.

Fine aggregates are present at the surface and can affect performance. Fine aggregates that contain larger particles of friable materials that are likely to break down under mechanical action should not be used.

Abrasion resistance may be enhanced by the use of dry shake finishes (see Sections 10.5 and 11.4).

Slip resistance

Most floors are finished by power trowelling to create a dense smooth surface. Therefore, under normal circumstances, the aggregates used have negligible effect on the slip resistance of the floor. See Section 5.9.

11.2.3 Drying shrinkage of aggregates

The principal effect of the aggregate is to restrain the contraction of the cement paste, thereby helping to reduce the likelihood of cracking. In general, aggregates with a higher modulus of elasticity (greater 'stiffness') and rough particle surface textures are likely to offer more restraint to concrete shrinkage.

The magnitude of shrinkage can vary substantially with type of aggregate. Quartz, granite and limestone are frequently associated with low concrete shrinkage, whereas sandstone and some basic igneous rock aggregates are more likely to cause or permit comparatively higher shrinkage.

Some aggregates notably but not confined to areas of Scotland have high shrinkage values, see BRE Digest 357⁽⁶⁸⁾. The drying shrinkage associated with aggregates should not exceed 0.075% when tested to BS EN 1367-4⁽⁶⁹⁾.

11.3 ADMIXTURES

11.3.1 Introduction

Admixtures can have substantial benefits for concrete for industrial floors in the following ways. They can:

- reduce the free water content while maintaining workability
- increase workability for rapid placement and compaction
- control setting to allow earlier finishing
- make finishing easier
- reduce drying shrinkage.

Careful selection is essential to obtain a satisfactory result. All admixtures should be used strictly in accordance with the manufacturers instructions. Incorrect use and inadequate mixing can lead to variable setting characteristics and poor performance.

The main benefits and limitations on the use of various admixtures are outlined below. Concrete Society Technical Report 18, *Guide to the selection of admixtures for concrete* ⁽⁸³⁾, is a useful reference.

11.3.2 High-range water-reducing admixtures

High-range water-reducing admixtures (HRWRA) are typically dosed at 0.30 to 1.5 litres per 100 kg of cement and give water reductions of up to 30% without reducing workability. Performance depends on several factors including admixture type and dose. High-range water reducers have greater dispersing power than normal plasticisers for an equivalent dosage.

Shrinkage of concrete occurs mainly in the cement paste and so to limit shrinkage, not only the water but also the cement content should be kept as low as possible. The large water reduction potentially available using a high-range water-reducing admixture should also allow cement content to be reduced while still achieving the required strength class.

For a given mix design, a high-range water reducer can be used to reduce the water content or cement content, to increase the workability, or a combination of these. Careful selection of a specific HRWRA helps to achieve a range of performance objectives such as retaining workability and stiffening characteristics at different ambient temperatures. Performance may depend on the type of cement used.

Some HRWRAs contain finishing aids. They are designed to work at the interface between the concrete surface and the power-finishing equipment to provide lubrication.

11.3.3 Normal water-reducing admixtures and retarding admixtures

Workability retention is usually more critical than retardation of setting. The use of a higher dosage of a slightly retarding water-reducing admixture to remove some water but also to increase initial workability will often be a better way of achieving the desired result.

Although normal water-reducing admixtures can be used successfully in concrete for floors, they should be used with particular care because of their relatively lower performance and tendency to cause retardation. Advice based on experience of their use in floors should be sought before specifying them or accepting a concrete that contains these products.

Careful attention to mix design and to mixing is essential if the concrete is to have uniform workability, cohesion and setting characteristics. This is particularly important when these water-reducing admixtures are used, as the low dose makes them difficult to disperse uniformly through the mix. Failure to mix thoroughly will cause variations between loads and within loads, which will result in 'soft' patches in the floors surrounded by concrete that has undergone initial set. Mortar paste may then be smeared across the set areas during finishing, causing problems with tolerances and with delamination of the surface and with appearance.

11.3.4 Accelerating admixtures

Most set accelerators are based on calcium nitrate. They may be useful in cold weather to reduce setting times and to avoid delays in the start of the finishing operations.

Calcium-chloride-based accelerators should not be used in slabs with any steel, including fibres, embedded in the concrete.

11.3.5 Shrinkage-reducing admixtures

Shrinkage-reducing admixtures are non-aqueous liquids that alter the mechanism of drying shrinkage in a way that reduces the internal stresses that lead to the formation of cracks. Reductions in shrinkage in the range 25–50% have been observed ⁽⁸⁾. Dosage is normally 5–7 litres/m³, and although this type of admixture is not water-based, the concrete mix water should be reduced by an amount equivalent to the admixture dose. Shrinkage-reducing admixtures can be used with other admixtures providing they are added separately. It is recommended that specialist advice is sought. They generally perform better when used with a high-range water-reducing admixture used to reduce total free water.

11.3.6 Air-entraining admixtures

Air entrainment is normally used to resist damage to exposed saturated concrete by freeze-thaw action and is therefore not applicable to most industrial floors. In cold stores the concrete is not saturated and the number of freeze-thaw cycles is very small, so air entrainment is not needed. Entrained air can cause problems with power-finished concrete floors, including delamination.

11.3.7 Concrete production with admixtures

To ensure uniform workability and setting across the slab when admixtures are used, it is particularly important that the order and timing of the concrete batching sequence is consistent. It is essential that flooring concrete is uniformly and consistently mixed and that admixtures do not come into direct contact with dry cement. Ideally, all components of the concrete should be mixed at the batching plant. If it is considered necessary to add materials at site, quality control procedures should include:

- procedures and records for the calibration and maintenance of dosing equipment, uniformity of dosing procedure, dosage rates, and re-mixing time
- procedures for recording the addition of admixtures, water or other materials including the time of addition, workability before and after addition, quantity of admixture or water added, additional mixing given.

This topic is discussed fully in Concrete Society Technical Report 18 ⁽⁸³⁾.

11.4 DRY SHAKE FINISHES

Dry shake finishes are dry blends of cements, fine aggregates, admixtures and sometimes pigments. They are

usually factory blended and supplied in bags. They are used for one or more of the following reasons:

- to enhance abrasion resistance
- to provide colour
- to help suppress steel fibres at the surface.

Dry shake finishes depend upon bleed water from the underlying concrete for hydration and for them to be worked monolithically into the base concrete. The take-up of water by the dry shake lowers the water/cement ratio, improving the quality of the near-surface concrete. Although excess bleed water should be avoided by appropriate mix design, it is equally important to have enough moisture at the surface when dry shake materials are applied.

Any enhancement in abrasion resistance over a direct finished concrete floor depends on the constituents and water/cement ratio of the base concrete, and the selected dry shake material and construction practice. When considering the use of dry shakes to enhance abrasion resistance, Section 10.5 should be studied carefully. In addition, the supplier should be able to demonstrate long-term performance.

When a coloured floor is required, the appearance of small laboratory-produced samples may not be representative of the finished floor. The colour of a concrete floor with a coloured dry shake finish is likely to be more variable than a resin coating or other applied coatings such as paint, see Section 5.4. Where appearance is important, advice on protecting new floors is given in Section 12.5.

For introductory guidance on the practical application of dry shake finishes, see Ref. 84.

11.5 STEEL FIBRES

The performance of steel fibres in relation to ductility is discussed in Section 7.4. The purpose of this section is to discuss steel fibres as they affect concrete mix design.

Mix design for steel fibre concrete

Depending on the overall grading of the available aggregates and the volume and type of steel fibre used, it may be necessary to increase fine aggregate content to improve fibre dispersion and to make the concrete easier to compact and finish. Increases in fines content will increase water demand. The fibres themselves will also have some effect on workability. High-range water-reducing admixtures are commonly used in steel-fibre-reinforced concrete.

Typical fibre dosages are 20–45 kg/m³. Concretes with higher fibre contents may be difficult to finish. The advice of the fibre suppliers should be sought before pumping steel fibre concrete.

Addition of fibres to concrete

Fibres may be added either at the batching plant or into the truck mixer on site. Fibres should always be added along with the aggregates or after the aggregates have been

batched. Fibres with an aspect (length/diameter) ratio greater than about 50 can be susceptible to agglomeration into balls in the concrete ('hedgehogs'). To reduce this risk, manufacturers use special packaging methods or equipment. Procedures should ensure thorough dispersal and it is recommended that quality control procedures should include checks on fibre content. It should be noted that 'hedgehogs' may also affect wire guidance systems.

Fibres on the surface

Steel fibres may be exposed at the concrete surface depending on the fibre type, dosage, mix design and finishing. Dry shake finishes can be used to reduce the likelihood of fibres appearing at the surface. Fibres that affect serviceability can be 'snipped off' when the concrete has hardened.

11.6 SYNTHETIC FIBRES

11.6.1 Introduction

It is necessary to distinguish between the short polypropylene 'micro' fibres and the larger synthetic fibres being developed for structural applications similar to steel fibres. The larger structural fibres are discussed in Chapter 7.

Short synthetic fibres (microfibres) do not provide any significant post-first-crack ductility, as defined and measured by Japanese Standard test method JSCE-SF4⁽⁴⁰⁾ (see Chapter 7).

11.6.2 Effects of microfibres on concrete properties

Polypropylene microfibres increase the homogeneity of the mix, stabilising the movement of solid particles and blocking bleed water channels. This reduces the amount and rate of bleeding of the concrete, which helps reduce plastic settlement.

Plastic shrinkage cracking can occur when the concrete surface is allowed to dry rapidly. This causes stresses that may exceed the tensile strength of immature concrete. Concrete is particularly susceptible to plastic shrinkage where there is air movement through openings in the building. These cracks occur soon after placing and tend to be oriented diagonally across the slab. The cracks are normally wider at the centre of the slab and narrower towards the edge. Cracks may occasionally penetrate to full slab depth due to continuous drying at the leading edges of the cracks. Polypropylene microfibres can increase the early-age tensile strain capacity of the plastic concrete, thus restricting the development of plastic shrinkage cracks. Plastic shrinkage cracks may not always be closed to their full depth by finishing operations.

By reducing bleed and segregation, polypropylene microfibres can help maintain the original water/cement ratio of the surface mortar, which can improve the surface layer and the abrasion resistance⁽⁸⁵⁾.

Floors subjected to repeated impacts may develop localised surface spalling or breakdown at joint arrises. Polypropylene fibres may be effective in distributing impact stresses and delaying deterioration.

PART FOUR

BEST PRACTICE IN CONSTRUCTION AND MAINTENANCE

The long-term performance of a floor is dependent on all those involved in the construction process carrying out all the essential operations – sub-base preparation, concreting, finishing, curing, joint cutting and sealing – correctly and at the right time. This Part outlines the key requirements of the construction of floors, and will therefore be of particular interest to those responsible for this stage of the operation. It will also be useful for owners/users, designers and planners of industrial facilities, so they appreciate the basic construction operations that must be carried out, and the longer-term maintenance requirements of concrete industrial floors.

CONTENTS

12 FRAMEWORK FOR GOOD SITE PRACTICE

- 12.1 Introduction
- 12.2 Health and safety
- 12.3 Pre-construction planning
- 12.4 Construction
- 12.5 Protection of the surface
- 12.6 Post-construction

13 MAINTENANCE

- 13.1 Introduction
- 13.2 Cleaning
- 13.3 Surface wear – abrasion
- 13.4 Surface wear – scouring and impact damage
- 13.5 Joints
- 13.6 Cracks

12 FRAMEWORK FOR GOOD SITE PRACTICE

12.1 INTRODUCTION

This chapter proposes checklists of the most important factors in successful construction of good quality floors. Many supervising engineers and contractors already have their own quality control procedures and these checklists are not intended to replace those. However, experienced contractors are advised to cross-reference their procedures against these lists, and it is hoped that those gaining experience in floor construction will benefit from the experience of others who have contributed here.

It is strongly recommended that supervising engineers and contractors develop quality control plans and that these should include checking and reporting procedures.

The following lists are intended to highlight the most important items to be monitored or checked. The lists are not comprehensive and those with responsibility for quality control should ensure that their own procedures are adequate.

A typical floor construction project is shown in Figure 12.1.

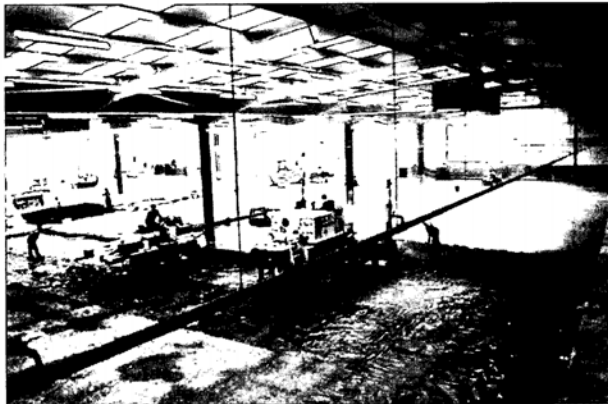

Figure 12.1: A well-laid sub-base is providing a sound platform for construction operations. Fabric is placed just ahead of the laser screed machine so it is not displaced by this mobile plant. The building is almost completely enclosed.

12.2 HEALTH AND SAFETY

All construction activity should comply with the requirements of the *Health and Safety at Work etc Act* ⁽⁸⁶⁾, the *Control of Substances Hazardous to Health (COSHH) regulations* ⁽⁸⁷⁾ and the *Construction Design and Management (CDM) regulations* ⁽⁸⁸⁾.

Key areas to be addressed should include:

- Material identification and selection, including product data and safety information for approval before use

- Risk assessment of the construction operation from design stage onwards taking environmental conditions into account
- Awareness of and compliance with site-specific health and safety requirements and including induction procedures
- Personnel health and safety requirements – current and up-to-date, including trade-specific training and associated training records
- Personnel structure, responsible representatives, reporting procedures and lines of communication identified
- Plant training and inspection certification.

12.3 PRE-CONSTRUCTION PLANNING

An essential part of a successful floor slab project is the pre-construction planning process. During this phase, the main contractor, main suppliers and specialist flooring contractor should address the construction and quality areas listed below.

The lines of communication between the parties to the project should be identified along with a clear understanding of individual responsibilities, including:

- Overall building programme enabling construction of the floor in a completed building envelope, totally protected from the weather
- Subgrade and sub-base suitability for the design and construction of the floor slab including finished level tolerances
- Floor slab construction programme, including access to clear building and storage areas, relationship with other trades, proximity of working, slab access requirements, and curing
- Post-construction access, including plans to avoid surface damage and overloading of newly completed slab
- Timescale for permanent loading
- Timescale for lowering temperature in cold stores
- Material supply, delivery and storage arrangements determined and back-up contingencies organised
- Specification and detailed design established and approved by all relevant parties
- Method of working established, including numbers of personnel, plant type and quantities, concrete supply and emergency joint detailing procedures in the event of breakdown in concrete supply

- Quality control procedures and compliance testing
- Calibration of specialist levelling, transmitting and receiving equipment.

These points can be covered by a number of means, the most common being the tender correspondence and pre-start meetings.

12.4 CONSTRUCTION

Within a period of a few hours the mixing, placing, compaction and trowelling of the concrete will influence the durability, appearance and structural properties of the floor long-term. A number of crucial elements are introduced on the day of construction and best practice must be followed to turn these activities and components into a good quality floor (Figure 12.2).

Guidance on basic good practice for construction in concrete can be found in the BCA guide *Concrete practice*⁽⁸⁹⁾.



Figure 12.2: Successfully completed floor.

Areas of practice that should be addressed during the floor construction process should include the following:

- Health and safety compliance and methods of work, including provisions for noise, dust and fume control, clean-up and waste disposal
- Delivery documentation check procedures against the specification for materials delivered, e.g. concrete grade, reinforcement type
- Sub-base surface regularity and stability check procedures, i.e. level grid prior to pouring and determination of resistance to rutting by construction traffic, including concrete delivery trucks
- Integrity and level of any slip or gas membrane

- Stable set-up of specialist laser levelling transmitters and receivers
- Level checking procedures for formwork, optical levels and laser equipment
- Installation of fabric or bar reinforcement to provide stable and suitable detailing, including correct use of chairs and spacers
- Control of allowable standing time for concrete delivery trucks with careful attention to delivery range and weather conditions
- Dosing and mixing procedures for steel fibres and admixtures where added at site
- Thorough mixing of concrete before discharge
- Application equipment and procedures for dry shake finishes
- Procedures for sampling and testing concrete and other materials, including concrete cubes, dosage and distribution of steel fibres, and spreading rates of dry shake finishes including dust and emission control
- Protection of adjacent works or perimeter walls or columns from splashes of concrete
- Assessing concrete before start of power floating and finishing operations
- Procedures for sawing restrained-movement joints
- Selection and application of curing compounds
- Preventing contamination of concrete surfaces by waste materials.

12.5 PROTECTION OF THE NEW FLOOR

The new floor should be left uncovered and undisturbed after construction for long enough for the concrete to gain strength, so that damage to the surface or joint arises is avoided. Ideally, this should be for three days, or longer in cold weather. If earlier access is required then additional care must be taken (Figure 12.3).

If the long-term appearance of a floor is particularly important, such as in retail premises, specific measures are required. These floors may incorporate dry shake finishes the appearance of which can be seriously compromised by damage or staining to the floor.

Where protection is required, it should be left in place for as short a time as possible and preferably removed at the end of each work shift. This will permit the concrete to lose moisture to the atmosphere without build-up of condensation, which may react with protective boarding and cause staining. Condensation under polythene can also irreparably mark the surface. Hoists and other vehicles should be fitted with tyre covers and oil drip catchers. The appearance of a new floor will improve over time with regular mechanised cleaning. This process can be accelerated, if required, by repeated early cleaning.

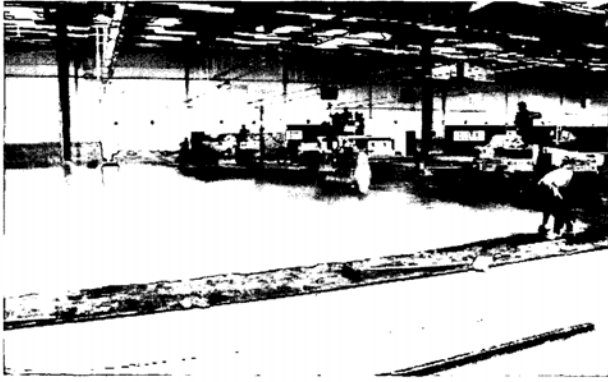

Figure 12.3: The edge of the previous pour (foreground) is protected by matting, which allows hand finishing of the edge of the new slab to be done easily and minimises the risk of splashes of wet concrete spoiling the appearance of the cast slab.

12.6 POST-CONSTRUCTION

After construction is complete, sampling and compliance testing reports (including the following) should be completed:

- Surface regularity survey
- Construction quality control reporting
- Information required under the *Construction Design and Management Regulations* ⁽⁸⁸⁾
- Information required for the operating and maintenance manuals.

13 MAINTENANCE

13.1 INTRODUCTION

Concrete floors require routine periodic inspection and maintenance in order to provide the on-going serviceability for which the floor was designed. Floors provide an operational platform for equipment. These operations create wear and tear that must be addressed on an on-going basis. As in many situations, failure to maintain concrete floors and joints invariably leads to higher long-term maintenance costs and lower efficiency – a ‘stitch-in-time’ philosophy of planned maintenance and repair should be adopted.

13.2 CLEANING

It is important to establish a cleaning regime that stops dirt and dust from building up; the operation of many types of materials handling equipment on dirty/dusty floors will cause increased wear on the floor. Power-floated concrete floors can normally be easily cleaned with a wet scrubber and vacuum-type machine using neutral (non-acid) detergents. Dry vacuum and sweeping will also remove dust and dirt deposits.

13.3 SURFACE WEAR – ABRASION

Rates of wear of concrete floors depend on the types of materials handling equipment, cleaning regime and traffic intensity on the floor. Many floors are sealed with acrylic or resin-type curing and sealing agents that penetrate the surface of the slab. These agents can be re-applied by roller or spray to heavily trafficked areas. Typically, in-surface sealers are re-applied periodically.

In extreme cases of accelerated wear the surface may have to be removed and resealed or reinstated.

13.4 SURFACE WEAR – SCOURING AND IMPACT DAMAGE

Areas of impact damage from dropped goods or scouring from MHE forks, etc. should be treated with a suitable epoxy mortar or resin to prevent further degradation of the affected area. Often the scraping of pallets and forks across the floor can damage the surface and cause joint arrises to spall. It is important to maintain pallets in good condition and to avoid unnecessary pushing of pallets and other equipment across the floor surface. Early repair will reduce the risk of accelerated degradation.

If heavy goods such as paper rolls are dropped, serious cracking of the slab may occur, requiring sections of slabs to

be removed and reinstated. In these cases, dowels should be drilled and resin-set into the existing slab to prevent vertical movement between the old and new sections. Some advice is given in *Concrete pavement maintenance manual*⁽⁹⁰⁾.

13.5 JOINTS

Joints typically require most attention in any maintenance plan, as they are the weakest feature of floors under intense MHE traffic. The edges of formed free-movement joints are prone to damage and so are sometimes constructed as armoured joints. These are more able to withstand wear although regular inspection and maintenance are still required. Sawn restrained-movement joints generally perform well although they are susceptible to heavy trafficking by small hard wheels (e.g. of pallet trucks). In heavily trafficked areas, unprotected arrises of these joints may suffer damage if the joints are not maintained.

Joint sealants should be inspected regularly and their ability to protect the arrises assessed. Once arrises are damaged the sealant may need to be replaced. Damage to arrises should be repaired as soon as possible as deterioration tends to accelerate once it has started.

Soon after the slab is constructed a ‘soft’ elastomeric mastic should be installed in the joints: this will permit a degree of movement and ‘stretching’ as the joint opens. This mastic provides no support to the arrises but will keep the joint free from dirt and debris. Once the mastic has reached the limit of its elasticity, it will de-bond from one of the joint faces and should be replaced under general maintenance.

When movement of the joints has stabilised, the mastic is replaced with a harder sealant that cannot accommodate such large joint movement but can provide support to the joint arrises. This sealant should be regularly inspected as any minor deterioration in the sealant can be successfully treated before significant damage to the joint arrises occurs.

It may prove necessary to replace ‘hard’ sealants in heavily trafficked MHE transfer aisles or collation areas periodically.

Before resealing joints, the cause of failure (e.g. splitting or debonding of the sealant, chemical attack, spalling of the arrises) should be established.

Splitting or debonding of the sealant is most likely to be due to excessive movement, which may have now stabilised. The use of a harder sealant is recommended for resealing where little movement is anticipated.

If chemicals may come into contact with the floor, the sealant manufacturer should be consulted for the most suitable

sealant. It should be noted that sealants often have lower chemical resistance than the epoxy or polyurethane materials used on floors where chemical spillage is likely.

Slight raveling of joint arrises is not usually detrimental to the operation of a joint. When the harder epoxy sealant is installed in the joint it will usually provide sufficient support to deal with minor damage to the arris. Where significant damage has occurred to the arris a concrete repair to re-form the joint may need to be carried out. Manufacturers should be consulted for details of the selection and application of suitable repair systems.

Joint sealants for use in cold stores must be suitable for installation and use of low temperatures.

13.6 CRACKS

As with joints, any cracks that develop should be monitored and, where appropriate, repaired. Fine cracks may only be a consideration of appearance, in which case they are best left untreated although they should be monitored as part of the floor inspection and maintenance regime. If the arrises of a crack begin to spall or the crack widens, it should be treated to avoid further deterioration. However, this should be balanced against a need to leave new cracks untreated until they have become dormant i.e. not undergoing any further opening. Where cracks are not dormant and it is considered essential to provide some degree of arris support, then semi-flexible sealants should be used.

REFERENCES

Readers should ensure that any standards and regulations consulted are the current issue.

This listing includes details of references that are included in the Appendices.

1. THE CONCRETE SOCIETY. *Concrete industrial ground floors – A guide to their design and construction*. Crowthorne, 1994. Technical Report 34, Second edition. 170pp.
2. THE CONCRETE SOCIETY. *Concrete industrial ground floors – Specification and control of surface regularity of free movement areas*. Supplement to Technical Report 34. Crowthorne, 1997. 32pp.
3. ASSOCIATION OF CONCRETE INDUSTRIAL FLOOR CONTRACTORS. *Guidance on specification, mix design and production of concrete for industrial floors*, Good Concrete Guide No. 1, The Concrete Society, Crowthorne, 1998. 24pp.
4. BUILDING RESEARCH ESTABLISHMENT. *Classes of imposed floor loads for warehouses*. (Neal, F. R. and Judge, C. J.) Information paper IP 19/87. BRE, Garston, 1987. 4pp.
5. DEACON, R.C. *Concrete ground floors. Their design, construction and finish*. Cement & Concrete Association, Wexham Springs, 1986. 24pp. Ref: 48.034.
6. THE CONCRETE SOCIETY. *The structural use of steel fabric reinforcement in ground-supported concrete floors*. To be published 2003.
7. DANLEY CONSTRUCTION PRODUCTS and PERMABAN PRODUCTS LTD. *Jointing systems in concrete structures. Testing of dowel systems*. School of Civil Engineering, Queensland University of Technology, May 2002. 25pp.
8. BISHOP, J.W. *The early age behaviour of concrete industrial ground floor slabs*. PhD thesis, University of Loughborough. December 2001. 255pp.
9. HULETT, T. *Abrasion resistance of power-finished concrete industrial floors; a state of the art review*, Diploma in Advanced Concrete Technology Project Report, Institute of Concrete Technology, Crowthorne, 2002. 38pp.
10. BRITISH STANDARDS INSTITUTION. BS 8204-2: 2002, *Screeds, bases and in-situ floorings. Concrete wearing surfaces. Code of practice*.
11. INTERNATIONAL ASSOCIATION OF COLD STORAGE CONTRACTORS. *Guidelines for the specification, design and construction of cold store floors*. Burks Green & Partners, Newark and the Association, Bracknell, 1993. 118pp.
12. BRITISH STANDARDS INSTITUTION. BS 6399-1: 1996 *Loading for buildings. Code of practice for dead and imposed loads*.
13. BRITISH STANDARDS INSTITUTION. BS 5606: 1990 *Guide to accuracy in building*.
14. BRITISH STANDARDS INSTITUTION. BS 7334: 1990 *Measuring instruments for building construction*. 8 parts.
15. BRITISH STANDARDS INSTITUTION. BS 8110 *Structural use of concrete, Part 1: 1997 Code of practice for design and construction. Part 2: 1985 Code of practice for special circumstances*.
16. BRITISH STANDARDS INSTITUTION. BS EN 1992-1. *Draft Eurocode 2, Design of concrete structures, Part 1, General rules and rules for buildings*.
17. THE CONCRETE SOCIETY. *Diagnosis of deterioration in concrete structures*. Crowthorne, 2000. Technical Report 54. 72pp.
18. PORTLAND CEMENT ASSOCIATION. *Effects of substances on concrete and guide to protective treatments*. PCA, Skokie, Illinois, 2001. PCA R&D serial No 2154. IS001.10.
19. BRITISH STANDARDS INSTITUTION. BS 8204-6: 2001 *Screeds, bases and in-situ floorings. Synthetic resin floorings. Code of practice*.
20. THE CONCRETE SOCIETY. *Non-structural cracks in concrete*. Crowthorne, 1992. Technical Report 22, Third edition. 48pp.
21. PLIMMER, J. *Delamination of concrete floor surfaces*. *Concrete*. Vol. 32, No. 6, June 1998. pp. 20–22.
22. UK SLIP RESISTANCE GROUP, *The measurement of floor slip resistance: Guidelines recommended by the UK Slip Resistance Group, Issue 2*, Circulated by RAPRA Technology, Shrewsbury, June 2000. 36pp.
23. SIMPSON, D. and WATSON, N. *Surface blemishes on power-trowelled concrete floors due to aggregate particles*. *Concrete*. Vol. 35, No. 8, September 2001. pp. 25–26.
24. HIGHWAYS AGENCY. *Manual of Contract Documents for Highways Works*. Volume 1, *Specification for highways works*, Series 600 Earthworks. London.
25. HIGHWAYS AGENCY. *Manual of Contract Documents for Highways Works*. Volume 1, *Specification for highways works*, Series 800, Road pavements – Unbound materials. London.
26. WESTERGAARD, H.M. *Computation of stresses in concrete roads, Proceedings of the fifth annual meeting of the Highway Research Board*, Vol. 5, Part 1, 1925. pp. 90–112.

27. WESTERGAARD, H.M. Stresses in concrete pavements computed by theoretical analysis. *Public Roads*. Vol. 7, No. 2, April 1926.
28. DARTER, M.I., HALL, K.T. and KUO, C-M. *Support under Portland cement concrete pavements*. Transportation Research Board, Washington DC, 1995. NCHRP Report 372. 50pp.
29. BRITISH STANDARDS INSTITUTION. BS 5930: 1999 *Code of practice for site investigations*.
30. BRITISH STANDARDS INSTITUTION. BS 1377: 1990 *Methods of test for soils for civil engineering purposes*. Multiple parts.
31. HIGHWAYS AGENCY. *Manual of Contract Documents for Highways Works*. Volume 1, *Specification for highways works*, Series 1000, Road pavements – Concrete and cement bound materials. London.
32. SIMPSON, D. Toward tolerant tolerances. *Concrete*. Vol. 35, No. 3, March 2001. pp. 45–47.
33. BRITISH STANDARDS INSTITUTION. CP 102: 1973 *Code of practice for protection of buildings against water from the ground*.
34. BRITISH STANDARDS INSTITUTION. BS 8103-1: 1995 *Structural design of low-rise buildings. Code of practice for stability, site investigation, foundations and ground floor slabs for housing*.
35. CARD, G.B. *Protecting development from methane*, Construction Industry Research and Information Association, London, 1996. Report 149. 190pp.
36. BRITISH STANDARDS INSTITUTION. BS 4449: 1997 *Specification for carbon steel bars for the reinforcement of concrete*. To be replaced by BS EN 10080.
37. BRITISH STANDARDS INSTITUTION. DD ENV 10080: 1996 *Steel for the reinforcement of concrete*. Due to replace BS 4483.
38. BRITISH STANDARDS INSTITUTION. BS 8666: 2000 *Specification for scheduling, dimensioning, bending and cutting of steel reinforcement for concrete*.
39. BRITISH STANDARDS INSTITUTION. BS 4483: 1998 *Steel fabric for the reinforcement of concrete*. To be replaced by BS EN 10080.
40. JAPAN SOCIETY OF CIVIL ENGINEERS. *Method of test for flexural strength and flexural toughness of SFRC*, Standard JSCE SF-4, 1985. Also published by Japan Concrete Institute.
41. BRITISH STANDARDS INSTITUTION. BS 7973 *Spacers and chairs for steel reinforcement and their specification*. Part 1. 2001 *Product performance requirements*. Part 2. 2001 *Fixing and application of spacers and chairs and tying of reinforcement*.
42. COLLEY, B.E. and HUMPHREY, H.A., *Aggregate interlock at joints in concrete pavements*. Portland Cement Association, Skokie, USA. 1967 Development Bulletin D124. (Also *Highway Research Record* No. 189, pp. 1-18.)
43. BRITISH STANDARDS INSTITUTION. BS 8000-16: 1997 *Workmanship on building sites. Code of practice for sealing joints in buildings using sealants*.
44. CHANDLER, J.W.E. *Design of floors on ground*. British Cement Association, Crowthorne, 1992. Technical Report 550. 22pp.
45. CHANDLER, J.W.E. and NEAL, F.R. *The design of ground-supported concrete industrial floor slabs*. British Cement Association, Crowthorne, 1988. Interim Technical Note 11. 16pp.
46. SHENTU, L., JIANG, D. and HSU, C.T. Load carrying capacity for slabs on grade. *Journal of Structural Engineering*, ASCE. Vol. 123, No. 1, January 1997. pp. 95–103.
47. CLEMENTS, M. Synthetics as concrete reinforcement. *Concrete*. Vol. 36, No. 8, September 2002. pp. 37–38.
48. BRITISH STANDARDS INSTITUTION. BS EN 1990: 2002 *Eurocode. Basis of structural design*.
49. MEYERHOF, G.G. Load carrying capacity of concrete pavements. *Journal of the Soil Mechanics and Foundations Division*, Proceedings of the American Society of Civil Engineers. Vol. 88, June 1962 pp. 89–166.
50. LOSBERG, A. Pavements and slabs on grade with structurally active reinforcement. *ACI Journal, Proceedings*. Vol. 75, No. 12, December 1978. pp. 647–657.
51. BAUMANN, R.A. and WEISGERBER, F.E. Yield-line-analysis of slabs-on-grade. *Journal of Structural Engineering*, ASCE. Vol. 109, No. 7, July 1983. pp.1553– 1568.
52. RAO, K.S.S. and SINGH, S. Concentrated load-carrying capacity of concrete slabs on grade. *Journal of Structural Engineering*, ASCE. Vol. 112, No. 12, December 1986. pp. 2628–2645.
53. BECKETT, D., VAN DE WOESTYNE, T. and CALLENS, S. Corner and edge loading on concrete industrial ground floors reinforced with steel fibres. *Concrete*. Vol. 33, No. 4, March 1999. pp. 22–24.
54. BECKETT, D. Strength and serviceability design of concrete industrial ground floors. *Industrial Floors '03*. Proceedings of Industrial Colloquium, Technical Academy of Esslingen, Germany, January 2003. Ed. Seidler, P. 2003. pp. 601–612.
55. HETENYI, M. *Beams on elastic foundations*. University of Michigan Press, Ninth printing, 1971.
56. YODER, E.J. and WITCZAK, M.W. *Principles of pavement design*. John Wiley and Sons, New York, Second Edition, 1975. 711pp.
57. FRIBERG, B.F. Design of dowels in transverse joints of concrete pavements. *Proceedings of the American Society of Civil Engineers*. Vol. 64, No. 9, 1938. pp. 1809–1828.
58. BRADBURY, R.D. Design of joints in concrete pavements. *Proceedings of the Highway Research Board*. Vol. 12, 1932. pp. 105–136.
59. WALKER, W.W. and HOLLAND, J.A. Plate dowels for slabs on ground (dowels for the 21st century). *Concrete International*. Vol. 20, No. 7, July 1998. pp. 32–38.
60. OZBEKI, M.A. *et al.* Evaluation methodology for jointed concrete pavements. Transportation Research Record, No. 1043. *Pavement system analysis* Kaplan, E.W. (Ed.) National Research Council, Washington, 1986. pp. 1–8.

61. TIMOSHENKO, S. and LESSELS, J.M. *Applied elasticity*. Westinghouse Technical Night School Press, Pittsburgh, Pennsylvania, 1925.
62. RILEM TC 162-TDF. (Vandewalle, L. *et al.*) Test and design methods for steel fibre reinforced concrete – design method. *Materials and Structures*. Vol. 33, No. 225, March 2000. pp. 75–81.
63. TIMMS, A.G. Evaluating subgrade friction-reducing mediums for rigid pavements. *Highway Research Board*. No. 60. 1964. pp. 48–59.
64. BRITISH STANDARDS INSTITUTION. BS 5328 *Concrete*. (Four parts) To be replaced by BS EN 206-1.
65. BRITISH STANDARDS INSTITUTION. BS EN 206-1: 2002 *Concrete*. Two parts.
66. BRITISH STANDARDS INSTITUTION. BS 8500: 2002 *Complementary British Standard to BS EN 206, Concrete*. Two parts.
67. NEVILLE, A.M. *Properties of concrete*. Addison Wesley Longman, Harlow, Fourth Edition 1995. 844pp.
68. BUILDING RESEARCH ESTABLISHMENT. *Shrinkage of natural aggregates in concrete*. Digest 357. BRE, Garston, 1991. 4pp.
69. BRITISH STANDARDS INSTITUTION. BS EN 1367-4: 1998 *Tests for thermal and weathering properties of aggregates. Determination of drying shrinkage*.
70. BAMFORTH, P.B. and PRICE, W.F. *Concreting deep lifts and large volume pours*. Construction Industry Research and Information Association, London, 1995. Report 135. 84pp.
71. HARRISON, T.A. *Early-age thermal crack control in concrete*. Construction Industry Research and Information Association, London, Second edition 1992. Report 91. 57pp.
72. BRITISH STANDARDS INSTITUTION. BS EN 12350-2: 2000. *Testing fresh concrete. Slump test*.
73. THE CONCRETE SOCIETY. *The influence of cement content on the performance of concrete*. Crowthorne, 1999. Discussion Document. Ref: CS 125. 48pp.
74. SADEGZADEH, M. *Abrasion resistance of concrete*. PhD thesis, University of Aston, Birmingham, 1984.
75. SADEGZADEH, M., PAGE, C.L. and KETTLE, R.J. Surface microstructure and abrasion resistance of concrete. *Cement and Concrete Research*. Vol. 17, 1987. pp. 581–590.
76. BRITISH STANDARDS INSTITUTION. BS EN 197-1: 2000 *Cement. Composition, specifications and conformity criteria for common cements*.
77. THE CONCRETE SOCIETY. *The use of GGBS and PFA in concrete*. Crowthorne, 1991. Technical Report 40. 144pp.
78. THE CONCRETE SOCIETY. *Microsilica in concrete*. Crowthorne, 1993. Technical Report 41. 56pp.
79. AMERICAN CONCRETE INSTITUTE. ACI 223-98 *Standard practice for the use of shrinkage-compensating concrete*. Farmington Hills, 1998. 28pp.
80. AMERICAN SOCIETY FOR TESTING AND MATERIALS. ASTM C845-96 *Standard specification for expansive hydraulic cement*. West Conshohocken, Pennsylvania, USA.
81. BRITISH STANDARDS INSTITUTION. BS 882: 1992 *Specification for aggregates from natural sources for concrete*. Replaced by BS EN 12620: 2002.
82. BRITISH STANDARDS INSTITUTION. BS EN 12620: 2002. *Aggregates for concrete*. Replaces BS 882.
83. THE CONCRETE SOCIETY. *A guide to the selection of admixtures for concrete*. Crowthorne, 2002. Technical Report 18. 68pp.
84. ASSOCIATION OF CONCRETE INDUSTRIAL FLOOR CONTRACTORS. *Dry shake finishes for concrete industrial floors. An introductory guide*. The Concrete Society, Crowthorne, 2001. Supplement to *Concrete*, November/December 2001. Ref: CS 142. 24pp.
85. VASSOU, V. and KETTLE, R.J. Abrasion resistance of fibre reinforced concrete floors. *Materials Week International Congress*, Munich, March 2000. Paper 349.
86. *Health and Safety at Work etc Act*. HMSO, London, 1994.
87. *The Control of Substances Hazardous to Health Regulations*, SI 437. The Stationery Office, 1999.
88. *Construction (Design and Management) Regulations*, SI 1994/3247. HMSO.
89. BRITISH CEMENT ASSOCIATION. (Blackledge, G.F., revised by Binns, R.A.) *Concrete practice*. Crowthorne, Third edition 2002. Ref. 48.037. 72pp.
90. BRITPAVE/Burks Green. *Concrete pavement maintenance manual*. The Concrete Society, Crowthorne, 2001. Ref: CS 138. 112pp.
91. DEUTSCHES INSTITUT FÜR NORMUNG. *Lagersysteme mit leitlinengeführten flurförderzeugen. (Warehouse systems with guided industrial trucks: requirements on the ground, the warehouse and other requirements)*. DIN 15185. 7pp. Beuth Verlag, Berlin GmbH, Berlin, August 1991.
92. DEUTSCHES INSTITUT FÜR NORMUNG. *Toleranzen in hochbau. Bauwerke. (Tolerances for buildings. Structures.)* DIN 18202. 8pp. Beuth Verlag, Berlin GmbH, Berlin, April 1997. (English translation)
93. FACE, A. Floor flatness and levelness: the F-number system. *The Construction Specifier*. Vol. 40, No. 4 April, 1987. pp. 124–132.
94. AMERICAN SOCIETY FOR TESTING AND MATERIALS ASTM 1155M-96. *Standard test method for determining F_F floor flatness and F_L floor levelness numbers*. West Conshohocken, Pennsylvania, USA.
95. COMITÉ EURO-INTERNATIONALE DU BÉTON. *The application of yield-line theory to calculations of the flexural strength of slabs and flat-slab floors*. Bulletin d'Information No. 35. CEB, Lausanne, 1990. 180pp.

APPENDICES

**APPENDIX A
MODEL DESIGN BRIEF FOR CONCRETE
INDUSTRIAL GROUND FLOORS**

**APPENDIX B
WORKED EXAMPLE: THICKNESS DESIGN OF A
GROUND-SUPPORTED FLOOR SLAB**

**APPENDIX C
FLOOR REGULARITY**

- C1 Developments in floor surveying
- C2 Alternative method for surveying defined-movement areas
- C3 Application of truck dimensions
- C4 Specifications outside the UK

**APPENDIX D
PILED SLABS**

- D1 Introduction
- D2 Alternative design approaches
- D3 Structural analysis
- D4 Section analysis
- D5 Joints in piled slabs

**APPENDIX E
DESIGN WITH FABRIC REINFORCEMENT**

- E1 Supplement to Chapter 9, strength and serviceability of slabs
- E2 Extension to Appendix B, thickness design of a ground-supported floor slab

**APPENDIX F
SOURCES OF INFORMATION**

APPENDIX A

MODEL DESIGN BRIEF FOR CONCRETE INDUSTRIAL GROUND FLOORS



This form may be copied and used freely, without copyright restrictions.

Area name/description Planned use

PART ONE: GENERAL INFORMATION

LOAD TYPE	DATA REQUIRED	VALUE	UNITS
Pallet racking Section 3.1 Chapter 9	Single leg load		kN
	Back to back spacing	B	mm
	Rack depth	C	m
	Rack length	A	m
	Aisle width	D	m
	Leg to MHE wheel spacing (maximum static load)	H ₁	mm
	Leg to MHE wheel spacing (maximum moving load)	H ₂	mm
MHE Section 3.2 Chapters 4 and 9 Appendix C	Maximum static wheel load		kN
	Maximum moving wheel load		kN
	Wheel contact area		mm ²
	Load axle width	E	m
	Rear axle width	F	m
	Front to rear axle length	G	m
UDLs Sections 3.1 and 9.9.5	Load per square metre		kN/m ²
	Aisle width if to be fixed		m
	Load width if to be fixed		m
Line loads Sections 3.1 and 9.9.5	Load per linear metre		kN/m
Mezzanine Chapter 9	Mezzanine leg load		kN
	Spacing		m × m
	Baseplate size		mm × mm
Other loads			

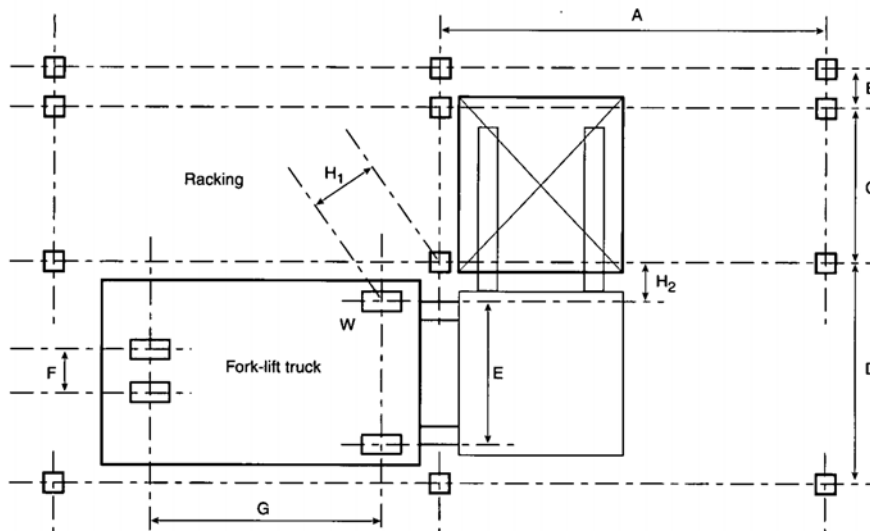

Key

- A Leg spacing along rack
- B Back to back leg spacing
- C Leg spacing across rack
- D Leg spacing across aisle
- E Truck load wheel spacing
- F Truck drive wheel spacing
- G Truck wheel base
- H₁ Distance of truck wheel from rack leg when the wheel load *W* is at its maximum value.
- H₂ Distance of truck wheel from rack leg when the truck is in motion.
- W Maximum wheel load.



PART TWO: SURFACE REQUIREMENTS CHECKLIST

	Check ✓ or N/A	Section Reference
Abrasion resistance		Section 5.2
Chemical resistance		Section 5.3
Colour and appearance		Section 5.4
Slip resistance		Section 5.9
Steel fibre visibility at the surface		Section 5.11
Joint types, layout and spacing		Chapter 8
Special requirements:		

Flatness		Chapter 4 and Appendix C
-----------------	--	---------------------------------

PART THREE: GENERAL

Floor to be loaded days after construction

Operating temperature/range

Environmental considerations
(e.g. ground conditions, gas venting)

Other

Licensed copy: atkins, Atkins Plc, 29/02/2008, Uncontrolled Copy, ©The Concrete Society

APPENDIX B

WORKED EXAMPLE: THICKNESS DESIGN OF A GROUND-SUPPORTED FLOOR SLAB

B1 INTRODUCTION

This worked example illustrates how the procedures in Chapters 7 to 9 can be applied to a steel-fibre-reinforced ground-supported slab subjected to a number of loading arrangements typically found in a large warehouse. This is extended in Appendix E for a fabric-reinforced slab. The layout of the warehouse, shown in Figure B1, is 50 × 120 m (6000 m² in area). The floor is to be constructed as a jointless floor with two formed free movement joints (each pour is 50 × 40 m = 2000 m²). The loadings considered are as follows:

- Back-to-back pallet racking
 - Maximum leg load 60 kN
- General storage/display
 - Uniformly distributed load 30 kN/m²
- Internal wall
 - Line load 30 kN/m
- Mezzanine
 - Column grid 5 m × 4 m, one level
 - $Q_k = 5 \text{ kN/m}^2$ (variable action/load)
 - $G_k = 1.25 \text{ kN/m}^2$ (permanent action/load)
- Materials handling equipment
 - Maximum wheel load 40 kN

B2 DESIGN DATA

- Materials:
- f_{cu} 40 N/mm²
 - f_{ck} 32 N/mm²
 - $f_{ctk(0.05)}$ 2.1 N/mm²
 - E_{cm} 33 kN/mm²
 - $R_{e,3}$ 0.5
 - k 0.05 N/mm²
 - ν 0.2

Partial safety factors:

- *Ultimate limit state*
 - Plain concrete and steel-fibre-reinforced concrete 1.5
 - Bar and fabric reinforcement 1.15
 - Permanent (static) actions 1.2
 - Dynamic actions 1.6
 - Variable actions 1.5
- *Serviceability limit state*
 - All partial safety factors 1.0

Assume a depth, h , of 175 mm.

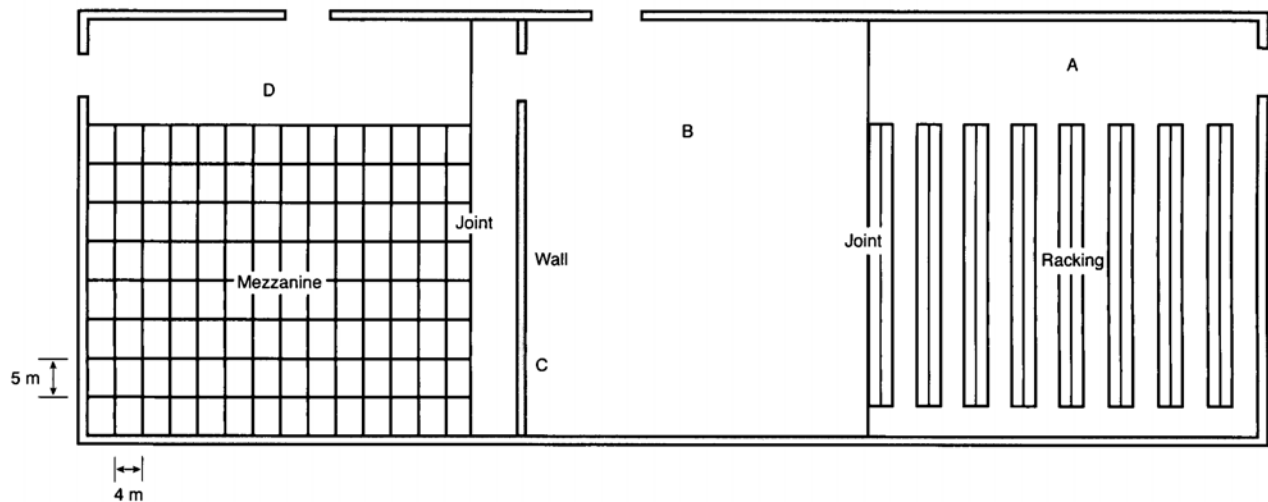

Figure B1: Plan of warehouse (not to scale).

$$f_{ctk,fl} = \left[1 + (200/h)^{0.5}\right] f_{ctk(0.05)} \leq 2f_{ctk(0.05)} \quad \text{Eqn 9.1}$$

$2f_{ctk(0.05)} = 2 \times 2.1 = 4.2 \text{ N/mm}^2$ that governs.

The radius of relative stiffness, l , is given by:

$$l = \left[\frac{E_{cm} h^3}{12(1-\nu^2)} k \right] \quad \text{Eqn 9.4}$$

$$= [33 \times 10^3 \times 175^3 / (12 \times 0.96 \times 0.05)]^{0.25} = 744 \text{ mm}$$

The negative moment capacity is given by:

$$M_n = \frac{f_{ctk,fl}}{\gamma_c} \left(\frac{h^2}{6} \right) \quad \text{Eqn 9.9}$$

Positive moment capacity, with $R_{e,3} = 0.5$, is given by:

$$M_p = \frac{f_{ctk,fl}}{\gamma_c} (R_{e,3}) \left(\frac{h^2}{6} \right) \quad \text{Eqn 9.8}$$

B3 ZONE A: RACKING

Details

Pair of back-to-back racking legs with a maximum load of 60 kN. Assume 100 × 100 mm baseplates at 250 mm centres.

$$a = [(100 \times 100) / \pi]^{0.5} = 56.4 \text{ mm}$$

Combined area (see Figure 9.4) = $(2 \times 56.4 \times 250) + 10,000 = 38,200 \text{ mm}^2$

$$\text{Hence: } a_{equiv} = (38,200 / \pi)^{0.5} = 110 \text{ mm}$$

$$\text{Thus: } a_{equiv}/l = 110 / 744 = 0.148$$

$$\text{Total load} = 2 \times 60 = 120 \text{ kN}$$

$$\text{Partial safety factor } \gamma_f = 1.2$$

$$\text{Hence ultimate load required} = 1.2 \times 120 = 144 \text{ kN}$$

Internal loading

For $a/l = 0$

$$P_u = 2\pi (M_p + M_n) = 134.5 \text{ kN} \quad \text{Eqn 9.10a}$$

For $a/l = 0.2$

$$P_u = 4\pi (M_p + M_n) / \left[1 - \frac{a}{3l}\right] = 288.2 \text{ kN} \quad \text{Eqn 9.10b}$$

For $a/l = 0.148$

$$P_u = 134.5 + (288.2 - 134.5) (0.148 / 0.2)$$

$$= 248.2 \text{ kN which is greater than the required 144 kN.}$$

Thus the slab is adequate for internal loading.

Loading at joints

Initially ignore load transfer. For $a/l = 0$

$$P_u = \left[\pi (M_p + M_n) / 2 \right] + 2M_n = 62.2 \text{ kN} \quad \text{Eqn 9.11a}$$

and with $a/l = 0.2$

$$P_u = \left[\pi (M_p + M_n) + 4M_n \right] / \left[1 - \frac{2a}{3l} \right] \quad \text{Eqn 9.11b}$$

$$= 143.6 \text{ kN}$$

For $a/l = 0.148$, interpolating between the two values gives:

$$P_u = 122.4 \text{ kN}$$

Thus for free edge loading $P_u = 122.4 \text{ kN}$, which is below the required 144 kN. This assumes free-edge loading with the baseplates at the slab edge. Load-transfer capacity will be available across the joint. It would be expected that this will be capable of supporting 20% of the load and this will have been checked with the designer of the load transfer system (see Section 8.8). This reduces the required load capacity to 115.2 kN and hence the design ($P_u = 122.4 \text{ kN}$) is adequate.

Corner loading

Corner loading is not considered as load transfer is provided as above and the edge condition has been considered, see Section 8.8.1.

Check for punching

Punching is not generally critical for internal loading. However, punching may be critical for the edge loading condition, see Figure B2.

The shear stress is checked at the face of the loaded area and on a perimeter at a distance $2d$ from the loaded area. Initially, check the punching shear capacity on the assumption that the slab is unreinforced, i.e. ignore the effect of the steel fibres or fabric reinforcement. For **unreinforced concrete** (see Section 9.10) $d = 0.75 \times h = 131.25 \text{ mm}$.

At the face of the loaded area

From Figure B2, the perimeter at the face of the contact area is:

$$u_0 = 350 + 2 \times 100 = 550 \text{ mm}$$

Hence the shear stress is given by:

$$v_p = (144 \times 1000) / (550 \times 131.25) = 1.99 \text{ N/mm}^2$$

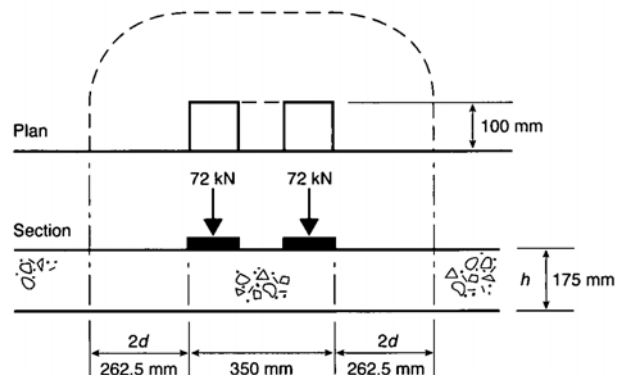

Figure B2: Punching shear perimeter at edge.

(Note that this is a conservative approach. Checking at the face of each loaded area individually gives $u_0 = 300$ mm and $v_p = 1.83$ N/mm².)

The shear stress should not exceed:

$$v_{\max} = 0.5 k_2 f_{cd} \quad \text{Eqn 9.28}$$

where $k_2 = 0.6 (1 - f_{ck} / 250) = 0.5232$

$= 5.49$ N/mm² which is significantly greater than the imposed 1.99 N/mm².

At the critical perimeter

At a distance of $2d$ from the face of the loaded area:

$$u_1 = 550 + (\pi \times 262.5) = 1375 \text{ mm}$$

For fibre-reinforced concrete the shear capacity is:

$$= (0.035 k_1^{3/2} f_{ck}^{1/2} + 0.12 R_{e,3} f_{ctk,n}) u_1 d \quad \text{Eqn 9.33}$$

where $k_1 = 1 + (200 / d)^{0.5}$

$= 2.23$ and therefore the maximum value of 2 is used.

$$= 0.56 + 0.17 = 0.73 \text{ N/mm}^2$$

Thus the shear capacity of the slab is given by:

$$P_p = 0.73 \times 1375 \times 131.25 = 131.7 \text{ kN}$$

This is less than the required 144 kN. This assumes free-edge loading with the baseplates at the slab edge. Again, it is assumed that 20% load transfer is available, reducing the required load capacity to 115.2 kN and hence the design is adequate.

B4 ZONE B: GENERAL STORAGE/DISPLAY

Random loading

Consider a uniformly distributed load = 30 kN/m². (The global safety factor of 1.5 has been accounted for in the calculation of M_n see Section B2.)

Note there is no reduction in flexural strength to account for restraint stresses.

Using the procedure in Section 9.9.5, the factor λ is given by:

$$\lambda = \left(\frac{3k}{E_{cm} h^3} \right)^{0.25} \quad \text{Eqn 9.15}$$

$$= [(3 \times 0.05) / (33 \times 1000 \times 175^3)]^{0.25}$$

$$= 0.9597 \times 10^{-3} \text{ mm}^{-1} = 0.9597 \text{ m}^{-1}$$

The maximum moment is negative (hogging) and is induced by the arrangement of loading shown in Figure B3 and given by:

$$w = \frac{1}{0.168} \lambda^2 M_n \quad \text{Eqn 9.19}$$

Taking M_n as the moment at first crack, the value of 14.3 kNm/m has been used and

$$w = (14.3 / 0.168) \times 0.9597^2$$

$$= 78.4 \text{ kN/m}^2, \text{ which is greater than the required } 30 \text{ kN/m}^2$$

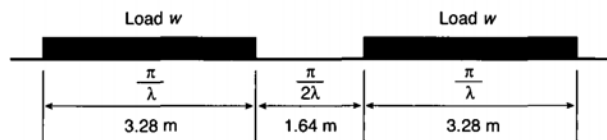

Figure B3: Arrangement of loads for maximum hogging moment.

Hence the slab is adequate for uniformly distributed loading.

B5 ZONE C: INTERNAL WALL (LINE LOAD)

Consider a line load of 30 kN/m. (The global safety factor of 1.5 has been accounted for in the calculation of M_p see Section B2.)

Note there is no reduction in flexural strength to account for restraint stresses.

Using the procedure in Section 9.9.5 and taking M_p as the moment at first crack, i.e. 14.3 kNm/m, then:

$$P_{lin,p} = 4\lambda M_p \quad \text{Eqn 9.16}$$

$$= 4 \times 0.9597 \times 14.3 = 54.9 \text{ kN/m}$$

This is greater than the required 30 kN/m and hence the slab is adequate.

B6 ZONE D: MEZZANINE

Assume a dead load of 1.25 kN/m² and a live load of 5 kN/m². Taking partial safety factors for these loads of 1.35 and 1.5, respectively (as in the draft Eurocode 2) gives a total design load of:

$$(1.25 \times 1.35) + (5.0 \times 1.5) = 9.2 \text{ kN/m}^2$$

Assume a baseplate grid as shown in Figure B4.

Assume a baseplate size of 250 x 250 mm.

Hence

$$a = (250^2 / \pi)^{0.5} = 141$$

$$all = 141 / 744 = 0.19$$

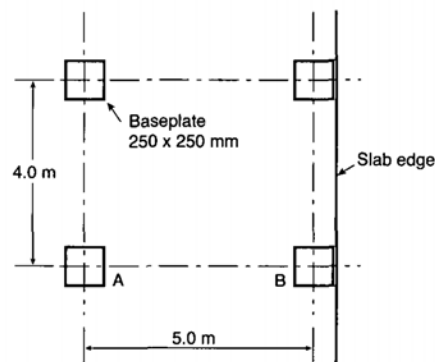

Figure B4: Arrangement of mezzanine baseplate grid.

For calculation purposes take $a/l = 0.2$

For plate A (internal):

$$P_{u(\text{reqd})} = (5 \times 4) \times 9.2 = 184 \text{ kN}$$

For plate B (free edge):

$$P_{u(\text{reqd})} = [(5 \times 4)/2] \times 9.2 = 92 \text{ kN}$$

Using the value of $M_p + M_n = 21.4 \text{ kNm}$, then:

For plate A (internal):

$$P_u = (4\pi \times 21.4) / (1 - 0.2/3) = 288 \text{ kN} \quad \text{Eqn 9.10b}$$

which is greater than the required 184 kN

For plate B (free edge):

$$P_u = (\pi \times 21.4 + 4 \times 14.3) / (1 - 2 \times 0.2/3) \quad \text{Eqn 9.11b}$$

Thus $P_u = 144 \text{ kN}$ which is greater than the required 92 kN

The punching shear check is as for Zone A and, by inspection, will be adequate.

B7 MATERIALS HANDLING EQUIPMENT

Details

The maximum wheel load is 40 kN with wheel contact dimensions of 165mm \times 40mm.

$$a = [(165 \times 40) / \pi]^{0.5} = 45.8 \text{ mm}$$

Partial safety factor $\gamma_f = 1.6$

Hence ultimate load required = $1.6 \times 40 = 64 \text{ kN}$

Internal loading

The negative moment capacity is given by:

$$M_n = (f_{ctk,n} / \gamma_c) (h^2 / 6) = 14.3 \text{ kNm/m} \quad \text{Eqn 9.9}$$

Positive moment capacity with $R_{c,3} = 0.5$ is given by:

$$M_p = (f_{ctk,n} / \gamma_c) (R_{c,3}) (h^2 / 6) = 7.2 \text{ kNm/m} \quad \text{Eqn 9.8}$$

For $a/l = 0$

$$P_u = 2\pi (M_p + M_n) = 134.5 \text{ kN} \quad \text{Eqn 9.10a}$$

For $a/l = 0.2$

$$P_u = 4\pi (M_p + M_n) / (1 - a/3l) = 288.2 \text{ kN} \quad \text{Eqn 9.10b}$$

For $a/l = 0.062$

$$P_u = 134.5 + (288.2 - 134.5) (0.062 / 0.2) = 182.4 \text{ kN}$$

which is greater than the required 64 kN.

Thus the slab is adequate for internal loading.

Loading at joints

Initially ignore load transfer.

For $a/l = 0$

$$P_u = [\pi (M_p + M_n) / 2] + 2 M_n = 62.2 \text{ kN} \quad \text{Eqn 9.11a}$$

For $a/l = 0.2$

$$P_u = [\pi (M_p + M_n) + 4 M_n] / (1 - 2a / 3l) = 143.6 \text{ kN}$$

For $a/l = 0.062$, interpolating between the two values gives:

$$P_u = 88.8 \text{ kN}$$

which is greater than the required 64kN

Thus the slab is adequate for edge loading.

Corner loading

It is assumed that the corner loading is not relevant provided adequate load transfer is provided and the edge condition has been considered, see Section 8.8.1.

B8 RELATIVE POSITION OF TRUCK WHEEL AND RACKING LEG

Referring to Figure B5, racking leg baseplate is 100 \times 100 mm, hence:

$$a = 56.4 \text{ mm}$$

For fork-lift truck:

$$a = 45.8 \text{ mm}$$

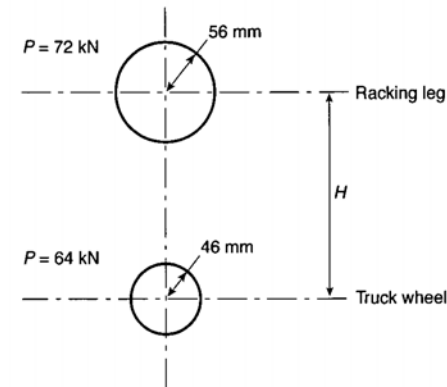

Figure B5: Equivalent loaded areas for racking legs and fork-lift truck wheels.

From site measurements H , the distance between the centres of the wheel and base plate, is approximately 300 mm.

An assumption is to consider two 72 kN loads i.e. 144 kN acting on two circular contact areas ($a = 50 \text{ mm}$)

$$a_{\text{equiv}} = [(\pi \times 50^2 + 2 \times 50 \times 300) / \pi]^{0.5} = 110 \text{ mm}$$

$$a/l = 110/744 = 0.134$$

Internal loading

By observation, see B3, the slab is adequate for internal loading.

Loading at joints

In this jointless floor, it is assumed that this truck wheel and racking leg configuration does not arise alongside the two formed free movement joints.

B9 DEFLECTION CHECK

From Section 9.12.2, and assuming that the edge condition is critical, then

$$\delta = c \left(\frac{P}{kl^2} \right)$$

Eqn 9.35

$$kl^2 = 0.05 \times 744^2 = 27,707$$

$$0.442 / kl^2 = 1.6 \times 10^{-5}$$

Taking $P = 120$ kN, the deflection $\delta_e = 1.92$ mm.

Assume no load transfer.

For the serviceability limit state the partial safety factors are taken as unity.

APPENDIX C

FLOOR REGULARITY

C1 DEVELOPMENTS IN FLOOR SURVEYING

In the development of this edition of TR 34, floor flatness was identified as a key issue. A working group was established to consider all aspects of floor flatness for both free-movement and defined-movement floors. Anecdotal evidence was found that the performance of materials handling equipment on some floors that complied with the appropriate classification in the 1994 edition of TR 34 was unsatisfactory. Representatives of MHE manufacturers on the working group considered that this was of sufficient importance to merit detailed investigation.

All of the factors potentially affecting the stability of MHE and its related ability to operate safely and efficiently were reviewed and the following conclusions were drawn:

- The existing method for surveying and specification of free-movement floors should remain broadly unchanged.
- Across-axle tilt of materials handling equipment, as measured by Property III, is the most important factor for defined-movement floors, as it most directly affects the interaction of MHE masts with racking.
- Excessive front-to-rear tilt, which is not presently measured, will create a 'pitching' effect on moving equipment, which will contribute to the overall dynamic movement of the masthead, associated driver fatigue and truck inefficiency.

There was insufficient time within the review period of this edition of TR 34 for a complete analysis of the effects of front-to-rear tilt to be commissioned, carried out and implemented. It was therefore concluded that the current method of measuring the surface regularity of defined-movement floors should remain unchanged from the 1994 edition. However, it was agreed that an informative appendix would be useful to provide a platform for future development. Face Consultants Ltd carried out surveys of 13 floors in operation and several newly completed floors constructed to evaluate the method outlined below and to establish the proposed limit values.

As part of the review, the working group has, in co-operation with the British Industrial Truck Association (BITA), examined methods used elsewhere in Europe and the USA. Also during the period of this review, the first steps towards a CEN Standard have been taken by the Fédération Européenne de la Manutention (FEM), which is BITA's European umbrella organisation. It was noted that both the US and German systems consider the effect of the rear wheels of trucks.

Only national standards that are in use are generally considered as starting points in the development of CEN and ISO standards, so it was considered important that the UK flooring industry should begin to develop a system that considers current UK construction practice.

The working group concluded that an alternative measurement method with provisional limits should be included as an informative appendix for the following reasons:

- As a platform for future research into the effect of the rear wheel on MHE stability, and to confirm the relationship between transverse and longitudinal stability.
- To produce a method of measurement that is appropriate to UK construction methods and which is suited to user needs.
- An FEM standard for truck stability is being developed and The Concrete Society, as lead authority on floors in the UK, is to be actively involved. This appendix will inform and support the Society's input to this work.

C2 ALTERNATIVE METHOD FOR SURVEYING DEFINED-MOVEMENT AREAS

In developing an alternative method for surveying defined movement areas, the working party examined methods used in other countries. The resultant method is closely allied to a similar US system, known as F_{min} . The proposed limits take account of the front-to-rear axle tilt of the materials handling equipment and the construction methods used in the UK.

When specifying this method of measurement, advice should be obtained on any implications for construction methods. It may be necessary to modify construction methods or to introduce different controls when placing the floor. This may have implications on cost, programme and joint design. For a full discussion on floor construction methods, see Section 2.2. Inadequately defined or constructed floors may result in an increased requirement for grinding, whereas floors constructed with additional quality control methods have fewer requirements for remedial work.

The profile of the floor is measured using a profilegraph, see Figure C1. Limits are applied that are related to the dimensions of the materials handling equipment intended to be used; the load-axle width and the front-to-rear wheelbase (Figure C2). Rear wheel configurations can be either single-wheeled or double-wheeled. The front-to-rear measurements are taken between the mid-points of the front and rear axles.

Four properties A, B, C and D are defined in Table C1. Properties A and C are elevational differences and are measured as

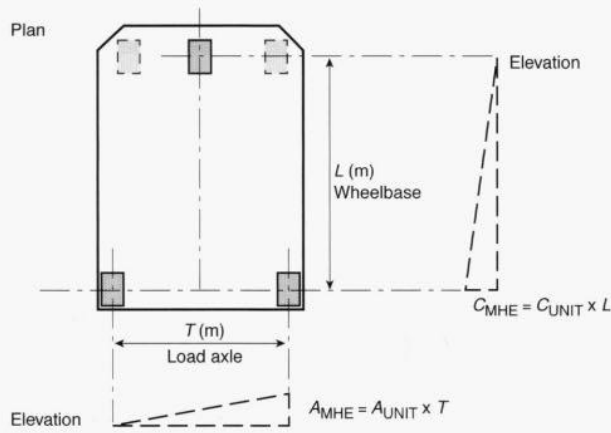

(a) Schematic of MHE.

(b) Schematic of profileograph

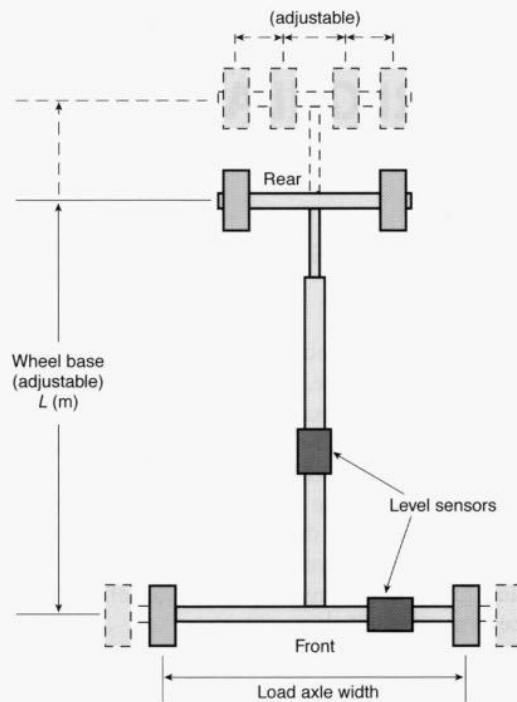

Figure C1: Survey method.

shown in Figure C2(a). Properties B and D are differences in elevational differences and are derived from Properties A and C, respectively, and are illustrated in Figures C3 and C4. Tables C1 to C3 show the method of calculating each Property.

Suggested limits based on the elevational difference of Property A_{unit} , expressed in mm per metre of load axle width for various heights of MHE, are given in Table C1. The limit values for given MHE dimensions (Properties A_{MHE} , B, C_{MHE} and D) are derived from Property A_{unit} .



Figure C2: Surveying a defined-movement area with a profileograph prior to installation of racking

Table C2 illustrates how these are converted to applied limit values for an MHE of typical dimensions. A further worked example showing the application of the procedure is given in Table C3.

To avoid accumulating rounding errors, limit values for Properties B and C should be calculated directly from the A_{unit} value for the specific MHE dimensions.

The limits shown in the above tables are intended to provide the performance to be expected from the MHE. When floors

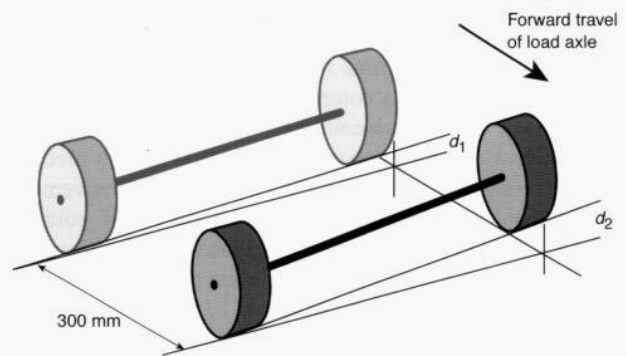

Figure C3: Property B ($= d_2 - d_1$)

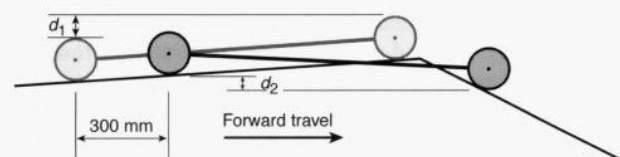

Figure C4: Property D ($= d_2 - d_1$)

Table C1: Floor classification for defined movement.

Floor classification	MHE lift height ^[1]	Property A _{unit} ^[2]	Property B	Property C _{unit}	Property D
		Transverse elevational difference unit value – mm per m of load axle length	Transverse rate of change for each 300 mm of forward travel. Fixed % of Property A _{MHE} value	Longitudinal elevational difference unit value – mm per m of front to rear axle length = A _{unit} × 1.1	Longitudinal change in elevational difference for each 300 mm of forward travel (mm) = A _{unit}
DM 1	Over 13 m	1.3	75	1.4	1.3
DM 2	8 to 13 m	2.0	75	2.2	2.0
DM 3	Up to 8 m	2.5	75	2.8	2.5

Notes:

[1] MHE heights are the same as those given in Table 4.3.

[2] A_{unit}, in effect, defines the floor quality and could, in principle, be used for specification purposes.

Table C2: Applied limit values for defined-movement areas for typical MHE with dimensions T = 1.3 m and L = 1.8 m.

Floor classification	Property A _{unit}	Property A _{MHE}	Property B	Property C _{MHE}	Property D
		T × A _{unit}	A _{MHE} × 0.75	L × C _{unit}	A _{unit}
DM 1	1.3	1.7	1.3	2.6	1.3
DM 2	2.0	2.6	2.0	4.0	2.0
DM 3	2.5	3.3	2.5	5.0	2.5

Note. The values given in Table C2 should be used when the actual truck dimensions are unknown at the time of construction.

Table C3: Worked example: applied limit values for defined-movement areas for MHE with dimensions T = 1.4 m and L = 2.0 m for a DM2 floor.

Floor classification	Property A _{unit}	Property A _{MHE}	Property B	Property C _{MHE}	Property D
		T × A _{unit}	A _{MHE} × 0.75	L × C _{unit}	A _{unit}
DM 2	2.0	1.4 × 2.0 = 2.8	2.8 × 0.75 = 2.1	2.0 × 2.2 = 4.4	2.0

For all classifications, all points surveyed should be within ± 15 mm from datum.

are constructed using techniques that are appropriate to these performance-related limits, it can be demonstrated statistically that a small number of readings are likely to fall outside these limits. Provided these readings are limited in number and size, it can be expected that they would have only minimal effect on the efficient operation of the MHE. This is a well-established feature in the control of tolerances in buildings – see BS 5606⁽¹³⁾.

Existing practice in the control of surface regularity of floors is to expect up to 5% of exceptional measurements to exceed the Property limit by up to a maximum of 1.5 times its value when measured after initial construction and before any remedial grinding or filling is carried out. This assumes that the measurements have a normal distribution of values.

The values are provisional and are based on analysis of operational VNA facilities and on experience in the USA. As far

as it is possible, comparisons have also been made with DIN 15185⁽⁷¹⁾.

In the F_{min} system, the unit value of Property C is the same as that of Property A. The working group considered this unnecessarily onerous and the unit value of Property C is therefore 10% more than the unit value of Property A. The effects of front-to-rear tilt and relationship between Property A and C is seen as a key area for future research in the adoption of a new measurement system.

Property D is not a function of the truck dimension and is fixed for each floor classification. Based on survey results, it has been set at the unit Property A value. This is less onerous than in the F_{min} system.

It is anticipated that the limits will be developed in the light of surveys carried out using the technique on newly constructed floors as part of the development of the FEM standard.

C3 APPLICATION OF TRUCK DIMENSIONS

Table C2 gives the limit values for a truck with a typical load axle width T of 1.3 m and front-to-rear wheelbase L of 1.8 m (see Figure C1). Where the MHE dimensions are not known, it is suggested that these values are used and a single rear wheel configuration assumed. In practice, the effect of variation from these dimensions is small. For example, for a DM2 floor, the difference between Property C_{MHE} values for trucks of length 1.8 and 2.0 m is 0.4 mm. Trucks with different dimensions may sometimes operate in the same aisles: again, it is not expected that this will present difficulties, and it is suggested that the truck length should be specified on the basis of the shorter of the wheelbases.

Another potential question relates to single or double wheel configurations. Where the truck type is not known, it is suggested that a three-wheeled configuration should be assumed as these are the most common. In any event, it is expected that, where a floor is suitable for a three-wheeled truck and significant grinding has not been carried out to 'tailor' that floor for a specific truck, the floor is likely in most cases to give good service for a four-wheeled truck. However, where grinding or other action is required, this should be done once the specific truck is identified.

It is thought likely that the method of arriving at the applied property values could be simplified with experience, with common values being applied over a range of truck lengths. The working group thought that an unnecessary degree of sophistication should be avoided, particularly until more experience has been obtained in the use of the measurement technique in the UK. However, it will always be preferable to define the MHE load axle width accurately as this defines the wheel tracks.

C4 SPECIFICATIONS OUTSIDE THE UK

Only a limited number of surface regularity specifications and associated surveying systems have been specifically developed for industrial, warehouse, retail and similar uses.

The principal ones, which are all used to some extent across Europe and elsewhere in the world, are:

- TR 34 (UK)
- F-numbers⁽⁹²⁾ and their derivative, F_{min} (USA)⁽⁹³⁾
- DIN 15185⁽⁹¹⁾ and DIN 18202⁽⁹⁴⁾ (Germany).

In free-movement areas TR 34 and F-numbers use similar surveying techniques. In both systems, it is assumed that the survey data follows a normal distribution and that the 95% and 100% limits are nominally two and three times the standard deviation, respectively. In the F-number system, the standard deviation of the survey results is calculated and converted to an F-number. The F-number for any standard of floor is inversely proportional to the expected standard deviation of the survey data for the floor. Therefore, a higher F-number denotes a flatter floor. There are separate F-numbers for flatness, F_F , and levelness, F_L . Consequently, TR 34 and F-numbers are directly comparable. TR 34 limits and corresponding F-numbers are given in Table C4.

In the USA, there is a derivation of F-numbers known as F_{min} , which is used in defined-movement areas. It is not possible to make direct comparisons with the existing TR 34 method as F_{min} measures the relationship between the front and rear axles of the truck. However, measurement of the elevational difference between the two front load wheels is common to TR 34 and F_{min} . The F_{min} system is the basis of the alternative method given in Section C2.

DIN 18202 is a general standard for construction tolerances and is similar in content to BS 5606. It is, however, often referred to in industrial floor specifications.

DIN 15185 is specific to MHE use in defined-movement areas only. The principal difference between DIN 15185 and TR 34 is that DIN 15185 requires the independent survey of all wheel tracks (three or four) over a range of chord lengths that reflect the longitudinal dimensions of MHE. As with TR 34, there is an over-riding requirement to limit the elevational difference across the front load axle.

As noted in Section C1, developments are underway to prepare an FEM standard, which may lead to a CEN standard.

Table C4: Comparison between surface regularity in free-movement areas measured by TR 34 limits and F-numbers.

	Flatness			Levelness		
	TR 34		F_F	TR 34		F_L
	95% limit (mm) Property II	Standard deviation		95% limit (mm) Property IV	Standard deviation	
FM 1	2.5	1.3	30	4.5	2.3	46
FM 2 (Special)	3.0	1.5	27	6.5	3.3	32
FM 2	3.5	1.8	22	8.0	4.0	26
FM 3	5.0	2.5	16	10.0	5.0	21

APPENDIX D

PILE-SUPPORTED SLABS

D1 INTRODUCTION

Where floors are constructed on poor ground, closely spaced piles may be used to transfer the loads to firmer strata. From a construction point of view, it is economic to transfer the slab loads directly to the piles without any beam supports or local thickening around the pile heads. However, punching shear around the piles may be the critical design criterion and hence some local thickening may be required.

Pile grids are normally in the range 3×3 m to 5×5 m, depending on the pile capacities and the intensity of loading. The aspect ratio of the panels should not exceed 1.25. Compared with normal suspended slabs, spans are short. It is recommended that the ratio of slab span (measured diagonally between the faces of the piles or enlarged pile heads as appropriate) to overall slab depth should not exceed 20, to avoid the need for detailed deflection calculations.

For piled slabs, it is assumed that the ground gives no support but simply acts as in situ formwork. The design of pile-supported slabs is not covered in detail in this report and they should be designed as suspended slabs, in accordance with the approaches in BS 8110 or the draft Eurocode 2.

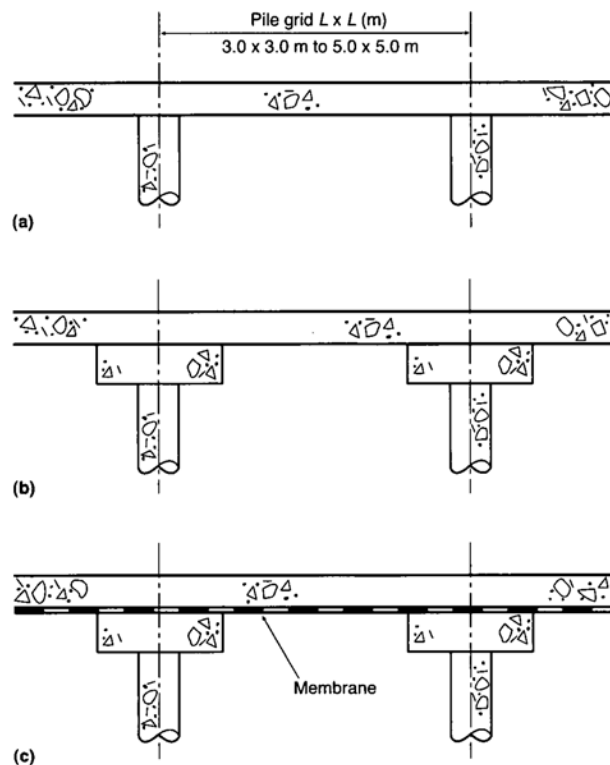

Figure D1: Cross-sections of typical piled slabs (not to scale).

D2 ALTERNATIVE DESIGN APPROACHES

In addition to the above 'conventional' design approach, various proprietary design approaches are available, based on steel fibre reinforcement alone or a combination of steel fibres and bar (or fabric) reinforcement in the form of a grid linking the pile heads. In the latter case, much of the load applied to the slab will be transferred by compressive membrane action to the 'beams' between the piles. Such proprietary designs are beyond the scope of this report. If they are used, the designer should be satisfied that the approach is sufficiently robust and has an adequate margin of safety.

D3 STRUCTURAL ANALYSIS

Guidance on the design of flat slabs is given in BS 8110 and the draft Eurocode 2. General analysis methods include:

- elastic bending moment and shear force coefficients based on plate equations
- grillage analysis
- yield line theory
- finite element techniques.

The use of yield line theory is a convenient method of analysis for pile-supported slabs for the ultimate limit state. There are various flexural failure modes for suspended flat slabs and guidance can be obtained from CEB Bulletin 35, *The application of yield-line theory to calculations of the flexural strength of slabs and flat slab floors* ⁽⁹⁵⁾.

D4 SECTION ANALYSIS

D4.1 Bar- or fabric-reinforced slabs

Analysis of sections in flexure and shear at the ultimate limit state should be in accordance with the methods in BS 8110 or the draft Eurocode 2. (It is not appropriate to use the equations for bending moment capacity presented in Chapter 9 that include the term a/l as this depends on the subgrade reaction.) The partial safety factors, for both materials and loads, should be in accordance with those given in the codes.

D4.2 Steel-fibre-reinforced slabs

Suggested stress blocks for section analysis in flexure at the ultimate limit state are shown in Figure F2 for sections with and without steel bar reinforcement. Note: these stress blocks are intended for pile-supported slabs only and should not be used for conventional suspended slabs.

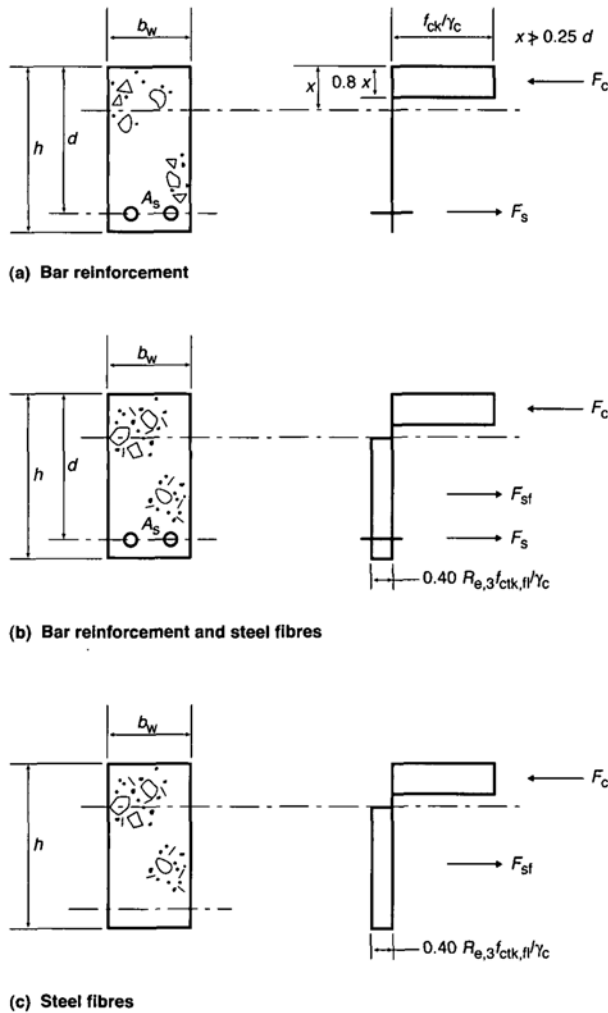

Figure D2: Stress blocks for concrete with steel fibres and/or reinforcement in flexure at the ultimate limit state.

The value of the ultimate flexural strength of the steel-fibre-concrete component will depend on the type and dosage of fibre and should be obtained where possible directly from the fibre manufacturer. Alternatively the design value for the ultimate flexural strength, $f_{ctd,fl,fibres}$, may be taken as:

$$f_{ctd,fl,fibres} = 0.4 \frac{f_{ctk,fl}}{\gamma_c} (R_{e,3}) \quad \text{Eqn D1}$$

D4.3 Punching shear

Punching of the slab, both under the action of point loads and around the heads of the piles, should be checked in accordance with the approach in Section 9.11. If a uniform slab thickness is used, punching around the pile heads is likely to be the dominant criterion and dictate the thickness of the slab.

D4.4 Serviceability

For conventionally reinforced slabs, the minimum reinforcement should be provided, in line with recommendations in the design codes, to control the widths of cracks caused by shrinkage and thermal movements, see Section 9.12. The amount required will be significantly greater than that generally used for ground-supported slabs. This follows from the fact that the design philosophies are different: in ground-supported slabs the aim is to **avoid** cracks on the top surface while with piled slabs the aim is to **control** the widths of any cracks that form.

There is a high risk of random cracking in suspended slabs due to the effects of shrinkage and the high overall restraint to shrinkage. The risk of cracking in pile-supported suspended slabs is greater than in similar elevated slabs, which can dry out from both the upper and lower surfaces.

D5 JOINTS IN PILED SLABS

D5.1 Introduction

Joints are dealt with in Chapter 8. It is not usually practical to provide joints in piled slabs at the close spacing of 5–6 m common in ground-supported slabs. There is therefore a greater risk of cracking. Reinforced suspended slabs are often ‘jointless’ in that free-movement joints are provided at intervals of up to about 50 m.

Joint layouts in piled slabs are largely dictated by the shear forces and bending moments but they should be planned to take account of serviceability problems in aisles. This needs particular attention where suspended slabs are built by long-strip methods.

D5.2 Tied joints

Joints in piled slabs are required to transfer significant shear forces and bending moments. Depending on loading patterns they will be required to transfer positive or negative bending moments and are typically detailed with bars of appropriate size and spacings at the top and/or bottom and of a length which gives full anchorage in accordance with BS 8110 or the draft Eurocode 2. The imposed forces on the joint can be determined by standard elastic analysis.

D5.3 Formed free-movement joints

Formed free-movement joints generally incorporate a proprietary armouring system. These are positioned where their ability to transfer shear forces can be used to maximum benefit and their inability to transmit bending moment has least effect. In particular, careful positioning can result in a ‘balanced’ section where the strength requirements of the slab near the joint are similar to those at other positions in the slab, leading to a consistent and simplified regime of slab construction. Otherwise, there can be significant stresses at these joints, requiring the bearing and burst-out capacity of the concrete to be checked as well as the load-transfer capacity.

APPENDIX E

DESIGN WITH STEEL FABRIC REINFORCEMENT

E1 SUPPLEMENT TO CHAPTER 9, STRENGTH AND SERVICEABILITY OF SLABS

Research commissioned for this edition has examined the potential for taking advantage of the structural enhancement provided by the nominal areas of steel fabric commonly used in ground-supported floors. Ductility requirements have been established in terms of rotation capacity and tests on beams of typical slab depths and associated fabric areas have confirmed that these rotations are easily achieved. Full-scale slab tests have confirmed that the Meyerhof analysis used in Chapter 9 is appropriate for establishing load-carrying capacity for point loads, with the positive moment capacity calculated by conventional lever arm methods in accordance with BS 8110 or the draft Eurocode 2. Full details of these tests and the related research are contained in a separate report ⁽⁶⁾.

To ensure adequate rotational capacity the positive moment capacity M_p should not exceed the negative moment capacity M_n . However, it is recommended that the commonly used steel areas of 0.1 to 0.125% are not exceeded, as discussed in Section 8.10.2.

The positive bending moment capacity M_p is calculated from:

$$M_p = \frac{0.95 A_s f_y d}{\gamma_s} \quad \text{Eqn E1}$$

where

A_s = area of steel

f_y = characteristic strength of steel

d = effective depth

γ_s = partial safety factor for steel (see Section 9.6.2)

Dimensions of standard square fabrics are given in Section 9.4.4.

As before, the negative bending moment capacity M_n is given by:

$$M_n = \frac{f_{ctk,fl} \left(\frac{h^2}{6} \right)}{\gamma_c} \quad \text{Eqn 9.9}$$

These recommendations apply to slabs reinforced with fabric (or bar reinforcement) located near the bottom surface. Slabs with fabric (or bar reinforcement) located near the top surface only should be designed as plain concrete slabs.

E2 EXTENSION TO APPENDIX B, THICKNESS DESIGN OF A GROUND-SUPPORTED FLOOR SLAB

The design example in Appendix B is for a steel-fibre-reinforced jointless slab. The example is extended here to a fabric reinforced slab with sawn-restrained movement joints at approximately 6 m intervals.

E2.1 Zone A: Racking – Ultimate limit state

For A142 fabric with 50 mm cover to the bottom of the slab:

$$d = 125 \text{ mm}$$

$$M_n = 14.3 \text{ kNm/m as before}$$

$$f_y = 460 \text{ N/mm}^2$$

$$M_p = A_s (f_y / 1.05) \times 0.95d = 7.4 \text{ kNm/m (equivalent fibre reinforced value} = 7.2 \text{ kNm/m from B3).$$

Internal loading

By observation, the internal capacity will be adequate. See B3.

Loading at joints

For fabric reinforcement with $a/l = 0$, $P_u = 62.7 \text{ kN}$

and with $a/l = 0.2$, $P_u = 144.8 \text{ kN}$

For $a/l = 0.148$, interpolating between the two values, gives:

$$P_u = 123.5 \text{ kN}$$

Thus for free-edge loading $P_u = 123.5 \text{ kN}$ for A142 fabric reinforcement, which is below the required 144 kN. This assumes free-edge loading with the baseplates at the slab edge. If the opening of the joint is restricted, it may be assumed that 15% of the load is transferred by aggregate interlock, reducing the required load capacity to 122.4 kN. For fabric, from Table 9.7, there would be an additional load-transfer capacity of 13.4 kN/m. This will be effective over a length of 0.9l either side of the load (see Section 8.8.4) giving a load transfer of $13.4 \times 2 \times 0.67 = 18.0 \text{ kN}$. Thus the required capacity is reduced to $122.4 - 18.0 = 104.4 \text{ kN}$ and hence the fabric reinforced design ($P_u = 123.5 \text{ kN}$) is adequate.

Check for punching at the critical perimeter (adjacent to a sawn joint)

For fabric reinforcement:

$$d = 125 \text{ and } u_1 = 550 + (\pi \times 250) = 1335 \text{ mm}$$

From Equation 9.30, the shear capacity of fabric-reinforced concrete is:

$$v_{rd,c} = (0.18/\gamma_c) k (100 \rho f_{ck})^{0.33} = 0.37 \text{ N/mm}^2$$

which is less than the minimum $0.035k^{3/2}f_{ck}^{1/2} = 0.56 \text{ N/mm}^2$ which should be used in design.

Thus the shear capacity of the fabric-reinforced concrete slab is given by:

$$P_p = 0.56 \times 1335 \times 125 = 93.5 \text{ kN}$$

Aggregate interlock and the dowelling effect of the fabric will reduce the required load capacity. As the baseplates are spaced 250 mm apart the effective length of joint over which load transfer will occur is increased from $0.9l$ either side to a total of $(2 \times 0.9l) + 250 = (2 \times 670) + 250 = 1590 \text{ mm}$. This results in $13.4 \times 1.59 = 21.3 \text{ kN}$ being transferred by dowelling, resulting in a required capacity of $122.4 - 21.3 = 101.1 \text{ kN}$. Hence the slab is inadequate in punching at the edge.

The required capacity could be achieved by increasing the effective depth to 135 mm (i.e. by reducing the bottom cover to the fabric to 40 mm), which would give a punching shear capacity of 105.7 kN. Alternatively steps could be taken to ensure that the baseplates are located a minimum of 70 mm from the edge. This would increase the punching perimeter to 1475 mm and hence the load capacity to 103.3 kN, making the design satisfactory.

E2.2 Materials handling equipment

By observation, the internal capacity will be adequate. See B7.

E2.3 Relative position of fork-lift truck and racking leg

Internal loading

By observation, see B7, the slab is adequate for internal loading.

Loading at joints

Initially ignore load transfer. For $a/l = 0$

$$P_u = [\pi (M_p + M_n) / 2] + 2 M_n = 62.7 \text{ kN} \quad \text{Eqn 9.11a}$$

and with $a/l = 0.2$

$$P_u = [\pi (M_p + M_n) + 4 M_n] / (1 - 2a / 3l) \quad \text{Eqn 9.11b} \\ = 144.8 \text{ kN}$$

For $a/l = 0.134$, interpolating between the two values gives:

$$P_u = 117.7 \text{ kN}$$

Thus for free-edge loading $P_u = 117.7 \text{ kN}$, which is below the required 144 kN. If the opening of the joint is restricted (see Section 8.8), it may be assumed that 15% of the load is transferred by aggregate interlock, reducing the required load capacity to 122.4 kN. For fabric, from Table 9.7, there will be an additional load-transfer capacity of 13.4 kN/m. This will be effective over a length of $0.9l$ either side of the load (see Section 8.8.4) giving a load transfer of $13.4 \times 2 \times 0.9 \times 0.744 = 17.9 \text{ kN}$. Thus the required capacity is reduced to $122.4 - 17.9 = 104.5 \text{ kN}$ and hence the design is adequate.

APPENDIX F

SOURCES OF INFORMATION

Association of Concrete Industrial Flooring Contractors (ACIFC)

33 Oxford Street, Leamington Spa
Warwickshire CV34 4RA
Tel: 01926 833633. Fax: 01926 423236
E-mail: acifc@hotmail.com
Website: www.acifc.org.uk

British Board of Agrément (BBA)

PO Box 195, Bucknalls Lane
Garston, Watford, Herts WD25 9BA
Tel: 01923 665300. Fax: 01923 665301
Website: www.bbacerts.co.uk

British Cement Association (BCA)

Century House, Telford Avenue
Crowthorne, Berkshire RG45 6YS
Tel: 01344 762676. Fax: 01344 761214
Email: info@bca.org.uk
Website: www.bca.org.uk

British Industrial Truck Association (BITA)

5-7 High Street, Sunninghill, Ascot, Berkshire SL5 9NQ
Tel: 01344 623800. Fax: 01344 291197
E-mail: info@bita.org.uk
Website: www.bita.org.uk

British Standards Institution (BSI)

389 Chiswick High Road, London W4 4AL
Tel: 020 8996 9000. Fax: 020 8996 7001
E-mail: cservices@bsi-global.com
Website: www.bsi-global.com

Building Research Establishment (BRE)

Garston, Watford WD25 9XX
Tel: 01923 664000
E-mail: enquiries@bre.co.uk
Website: www.bre.co.uk

Construction Industry Research and Information Association (CIRIA)

6 Storey's Gate, London SW1P 3AU
Tel: 020 7222 8891. Fax: 020 7222 1708
E-mail: enquiries@ciria.org.uk
Website: www.ciria.org.uk

Cement Admixtures Association (CAA)

38a Tilehouse Green Lane, Knowle, West Midlands B93 9EY
Tel: 01564 776362. Fax: 01564 776362
Website: www.admixtures.org.uk

The Concrete Society

Century House, Telford Avenue
Crowthorne, Berkshire RG45 6YS
Tel: 01344 466007. Fax: 01344 466008
E-mail: enquiries@concrete.org.uk
Website: www.concrete.org.uk

Fédération Européenne de la Manutention

(European Federation of Materials Handling and Storage Equipment)

c/o Orgalime, Diamant Building, 80 Boulevard A. Reyers
B-1030 Brussels, Belgium
Tel: 2-706 82 35. Fax: 2-706 82 50
E-mail: guy.vandoorslaer@orgalime.org
Website: www.fem-eur.com/

International Association for Cold Storage Construction

European Division
Downmill Road, Bracknell, Berkshire RG12 1GH
Tel: 01144 01344 869533. Fax: 01344 869527
Website: www.iascs.org

Loughborough University

Department of Civil and Building Engineering
Loughborough University
Loughborough, Leicestershire LE11 3TU
Tel: 01509 222884. Fax: 01509 223981
E-mail: Civ.Eng.enq@lboro.ac.uk
Website: www.lboro.ac.uk/departments/cv

Packaging and Industrial Films Association (PIFA)

2 Mayfair Court, North Gate, Nottingham NG7 7GR
Tel: 0115 942 2445. Fax: 0115 942 2650
E-mail: pifa@pifa.co.uk
Website: www.pifa.co.uk

Storage Equipment Manufacturers' Association (SEMA)

6th Floor, The McLaren Building
35 Dale End, Birmingham B4 7LN
Tel: 0121 200 2100. Fax: 0121 200 1306
Website: www.sema.org.uk

UK CARES

Pembroke House, 21 Pembroke Road
Sevenoaks, Kent TN13 1XR
Tel: 01732 450000. Fax: 01732 455917
E-mail: general@ukcares.com
Website: www.ukcares.com

United Kingdom Warehousing Association (UKWA)

Walter House, 418-422 Strand, London WC2R 0PT
Tel: 0207 836 5522/0449. Fax: 0207 379 6904
E-mail: dg@ukwa.org.uk
Website: www.ukwa.org.uk

UK Slip Resistance Group (UKSRG)

RAPRA Technology Ltd
Shawbury, Shropshire SY4 4NR
Tel: 01939 250383
Website: www.rapra.net

SPONSOR PROFILES

The companies featured on the following pages sponsored the project to develop this edition of Technical Report 34. The Society is pleased to have the opportunity to feature their specialist expertise and services in this section of the report.

SPONSORS

Association of Concrete Industrial Flooring Contractors (ACIFC)

ABS Brymar Floors Ltd

A J Clark Concrete Flooring Ltd

Bekaert Building Products Ltd

BRC

Cement Admixtures Association

Combined Floor Services

Don Construction Products Ltd

Face Consultants Ltd

Fibercon UK

Fosseway Flooring Systems Ltd

Gomaco International Ltd

John Pyatt Concreting Ltd

Kent Wire (ISPAT) Ltd

Mike Amodeo (Contractors) Ltd

Permaban Products Ltd

Precision Concrete Floors

Ready-mixed Concrete Bureau

(Note: The Ready-mixed Concrete Bureau is changing its function and operation in 2003 and so a detailed profile is not included in the following pages.)

ROM Ltd

Rinol Silidur

Sika Armorex

Snowden Flooring Ltd

Somero Enterprises Ltd

Stanford Industrial Concrete Flooring Ltd

Stuarts Industrial Flooring Ltd

Synthetic Industries

Twintec Industrial Flooring Ltd

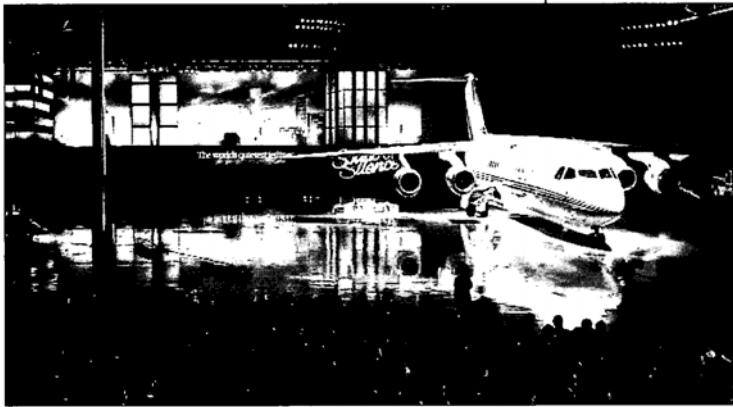
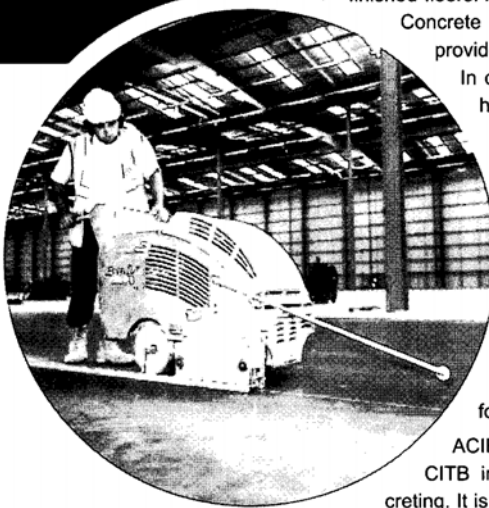
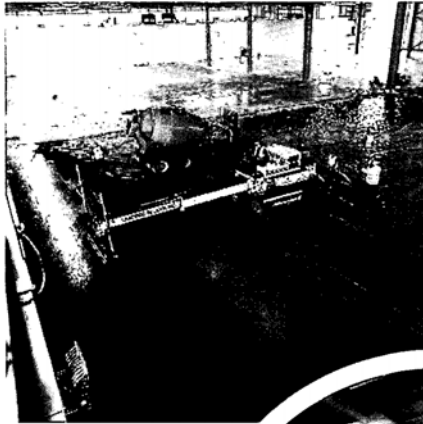

The Association of Concrete Industrial Flooring Contractors (ACIFC) was established in 1994 to represent the interests of contractors and suppliers who were engaged in the burgeoning business of providing ground floor slabs for retail and industrial warehouses and new production facilities. New techniques had emerged from the USA and Scandinavia that required the development of codes that would allow these to be exploited to the full.

At the same time it was clear that, with the rapidly expanding demand, methods of measuring the surface had to be upgraded, and joints and reinforcement moved on to cope with the opportunities for output levels that could not be sustained by traditional means.

Today, the Association has approaching 50 Members. Contractor Members account for an estimated 70% of ground-supported industrial slab production in the United Kingdom, placing some 1.75 million cubic metres of concrete to complete around 8 million square metres of floor each year. Associate Members range in the supply chain from concrete producers to test laboratories, from floor surveyors to suppliers of admixtures, fibres, joints and surface treatments.

ACIFC seeks advances in technical standards, quality and consistency of finished floors. ACIFC Members support the provision of such guidance as The Concrete Society's Technical Report 34, not just as users, but also as providers of industrial funding to match the support from government.

In collaboration with The Concrete Society, ACIFC working parties have developed key guidance documents on:

- floor flatness
- concrete mix design and admixtures
- steel fibre reinforcement
- dry shake finishes
- plant safety and training
- suspended floor slabs
- site working arrangements.

Consideration is being given to other important topics such as foundations, joints and environmental conditions.

ACIFC works with BCA on issues such as sustainability, and with CITB in developing national occupational standards for in situ concreting. It is a member of the National Specialist Contractors Council to deal with commercial matters.

The Association is affiliated with ACIFC France in collaboration to establish improved standards of construction and especially measurement of floor surface finish and flatness.

While the criteria for membership confirm the Member as a specialist in industrial concrete floor construction, the Association is open to all those who undertake long strip, wide bay or flood floor techniques and to the supporting supply chain. Members give generously of their time and resource to resolve recurring issues and trial new materials and services to improve the quality of the end product.

Association of Concrete Industrial Flooring Contractors

33 Oxford Street, Leamington Spa, UK, CV32 4RA

Tel: 01926 833633, Fax: 01926 423236

E-mail: acifc@hotmail.com

Website: www.acifc.org.uk

The joint enterprise of flooring specialists ABS Brymar Floors with Kontrad Associates, an engineering and consultancy company, was established nearly 40 years ago. We are able to undertake the full range of industrial flooring construction projects from design to completion. Our organisation is at the cutting edge of technology and employs a workforce trained to meet the client's specification in terms of flatness and serviceability.

ABS Brymar Floors specialises in:

- Design and construction of industrial floors
- Suspended steel-fibre floors
- Jointless floors
- Concrete overlays on existing floors
- External concrete roads and hardstandings

CONSTRUCTION

ABS Brymar Floors can offer a full service from advising on sub-base preparation and plate bearing tests prior to pouring right through to laying and finishing the floor. We provide the management, expertise, financial backing and skilled labour to successfully complete all ground floor projects. We utilise the Somero Laser Screed and the Somero STS 130 Mechanical Spreader.

All floors are fully indemnified, providing an unrivalled package for main contractors, engineers and end-users. Independent profileograph reports undertaken after floor-laying repeatedly confirm the tolerances achieved. All information obtained from site testing is analysed by our engineers and presented to clients in a professional format clearly showing all data.

DEVELOPMENT

Providing the management, expertise, financial backing and skilled labour to successfully complete all ground floor projects, ABS Brymar Floors has developed the use of steel and polypropylene fibres for industrial flooring applications over many years.

Our highly trained draughtsmen generate drawings for proposed schemes and construction details, manipulating advanced CAD software utilising the latest technology. A full design package is offered and undertaken by our experienced in-house design team to fulfil the requirements and demands of any client's brief.

CASE STUDY

ABS Brymar Floors were the first to incorporate three materials in constructing the floor for a new 7000 m² distribution warehouse in Burnley, UK. A combination of steel and polypropylene fibres together with traditional reinforcement cages plays a key part in the design of a high quality industrial floor. The addition of steel fibres to the concrete creates a 3-D reinforcement and, by individually providing anchorage in the concrete, the fibres can enhance this brittle matrix, giving a ductile material with a high load carrying capacity.

Using mass-pour construction techniques with the Somero 240 Laser Screed and STS130 dry shake spreader, this floor has many benefits over traditionally suspended floors. In addition, the combination of fibres and conventional rebar gives high crack control performance, with the floor designed in accordance with Eurocode 2 and to specified crack widths at the request of the client.

Over the last 20 years, the use of steel fibres in ground-supported industrial floors has been accepted and, with notable advantages in terms of price and performance, the use of steel fibres for this application continues to grow.

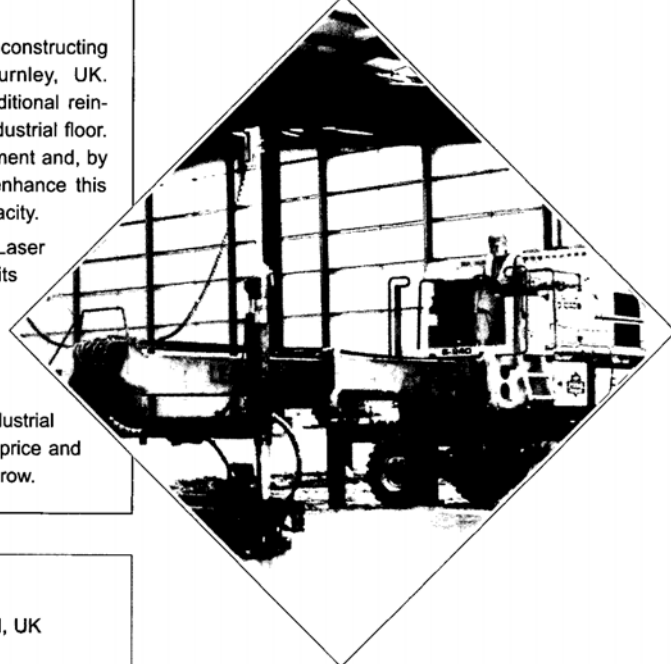
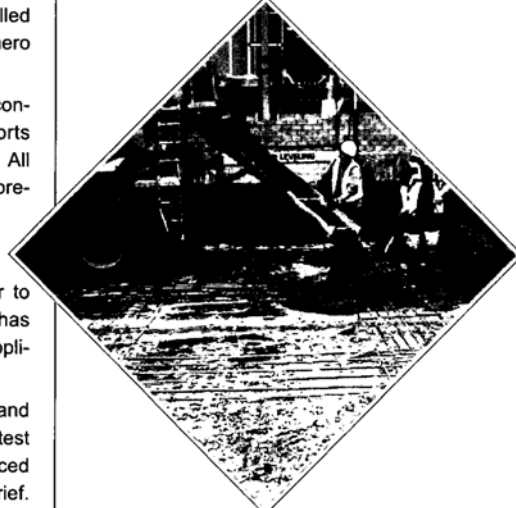

ABS Brymar Floors Ltd

Dane Road, Dane Road Industrial Estate, Sale, Cheshire, M33 7BH, UK
 Tel: +44 (0) 161 972 5000, Fax: +44 (0) 161 972 5001
 E-mail: sales@absbrymarfloors.co.uk
 Website: www.absbrymarfloors.co.uk



A J Clark Concrete Flooring was launched in 1996 and is part of the A J Clark Group. The Directors combine over 20 years of experience managing major projects.

To date, every A J Clark project has been completed on time and within budget. This factor alone provides one of the strongest foundations for our planned growth. In an independent construction customer survey, the A J Clark Group were reported to be demonstrating an exceptional ability to manage every aspect of the job, coordinating men, machines and materials in projects of £100,000 to several million pounds.

TECHNOLOGICAL ADVANCES

- Today's laser screed technology allows a skilled team to complete 20 m² in a single pass. That means a team of seven can complete 2000 m² plus in a working day. A J Clark was the first Scottish registered company to own and regularly operate a laser screed in Scotland.
- Laser screeding consistently out-performs hand screeding for precision and speed of flooring and paving. Lower costs, reduced manpower, increased mobility and greater accuracy guarantee the skilled teams will be 'on' and 'off' site with exceptional efficiency. This creates early access for the following trades and delivers improved customer satisfaction.
- The A J Clark Group are regular delegates at 'The World of Concrete' in the USA, and deliver the latest initiatives and technology, such as steel fibres, to benefit their UK customers.
- The A J Clark Group is also able to offer optimal solutions to a range of diverse problems, such as:
 - Steel fibre jointless pours installed by laser screed
 - Pile-supported steel fibre floors installed by laser screed.

It makes sense to contract the first Scottish registered company to own and regularly operate a Laser Screed and Dry Shake Topping Machine in Scotland.

A J Clark understands you want to keep costs down, while you need guarantees of the highest quality – and that access for other trades must not be delayed. To achieve this, A J Clark Flooring division have invested in the latest laser screed and automated paving technology. In addition traditional and flood pouring techniques are in accordance with Concrete Society Technical Report No. 34.

WORKING SMARTER

This allows the A J Clark team to create for you minimum maintenance, flat, level and durable internal concrete flooring and external concrete pavements.

A UK First – A J Clark could shout about being first in the UK to use steel fibres in conjunction with a slipform paver designed to 'build in' ever greater strength and reduce concrete costs.

Rolls Royce – A J Clark were commissioned by Amec, the main contractor, to design and install 48,000 m² of steel fibre pile-supported and jointless concrete floor slab, all installed by laser screed and automated dry shake spreader.

Results – With all A J Clark projects, UK-wide, completed in the last three years, on time and to budget, A J Clark's results speak for themselves.

BEST VALUE

So what makes A J Clark better? Simply, our approach to doing business and early involvement of experts. Experienced in major flooring design and build projects, we will work with you to ensure the best value solution. Advising on techniques that will save you cost and time, without compromising quality.



A J Clark Flooring Ltd

Clark House, High Glencairn Street, Kilmarnock KA1 4AB, UK
Tel: 01563 539993 Fax: 01563 570197

Bekaert is a technology-driven business that produces and markets a wide range of products based on metal transformation and coating technologies. The Group's activities are built around four business units: Wire, Merchant Products, Steel Cord, and Bekaert Advanced Materials.

Bekaert has grown from a small manufacturing and trading company, founded by Leo Leander Bekaert in 1880, into a global group with its head office in Belgium. Starting in Western Europe, the group moved into North America and Latin America and has been expanding rapidly in Asia in recent years. Bekaert now has 96 production centres in 29 countries and an extensive network of sales offices and agencies, employing around 17,500 people.

Bekaert Building Products are based in Sheffield, and entered the UK industrial flooring market with their steel wire fibre, Dramix®, in 1990. Produced by the cold drawing process, which increases the tensile strength of the wire and guarantees its length and diameter, Dramix® fibres give the complete concrete reinforcement solution. Providing excellent anchorage through its distinctive hooked end, Dramix® can enhance the concrete's properties in terms of crack control, increasing load-carrying capacity, and improving impact and fatigue resistance.

Sold into industrial flooring globally for over 30 years, the main advantages of using Dramix® are the time savings achieved by the removal of traditional reinforcement, the possibility of 'jointless' floors, the reduction of traditional bar in conventional piled floor solutions, and potential savings in overall construction costs.

FLOORING APPLICATIONS

- **Traditional jointed floors:** By replacing traditional steel fabric reinforcement with Dramix® steel fibres, overall material costs are reduced and the construction process is simplified.
- **'Jointless' floors:** Using laser screed technology, large area panels free of internal stress-relieving joints can be constructed due to the enhanced crack-distribution characteristics of the high length/diameter ratio Dramix® fibres.
- **Piled floors:** Bekaert's patented piled floor system, combining Dramix® steel fibres and traditional steel cages, designed in accordance with Eurocode 2, minimises steel fixing time and increases productivity.
- **External yards:** Set-up time can be reduced by the absence of steel mesh, whilst increasing impact and fatigue resistance to heavily trafficked areas.
 - **NEW! Multi-storey decking:** By replacing mesh with Dramix® and utilising the Ward Multideck 60 profiled metal deck, construction advantages include:
 - time and concrete volume savings
 - ease of construction
 - reduced materials storage required
 - simplified transport of materials to the construction face
 - reduced trip hazards due to the removal of mesh.

With proven 1.0 and 1.5-hour fire ratings, through work at Warrington Fire Research and technical support by the SCI, multi-storey and mezzanine applications can be catered for.

Linking all of these technical benefits with our free, fully indemnified design service, and the use of specialist flooring contractors, you have a fast and very efficient

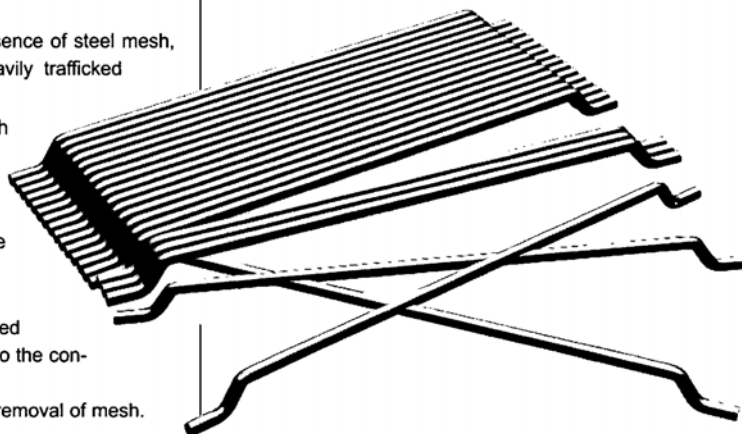

Bekaert Building Products

PO Box 119, Shepcote Lane, Sheffield S9 1TY, UK
 Tel: +44 (0) 114 2244 487, Fax: +44 (0) 114 22 44 564
 E-mail: buildingproducts@bekaert.com
 Website: www.bekaert.com/building



WWW.BRC-UK.CO.UK

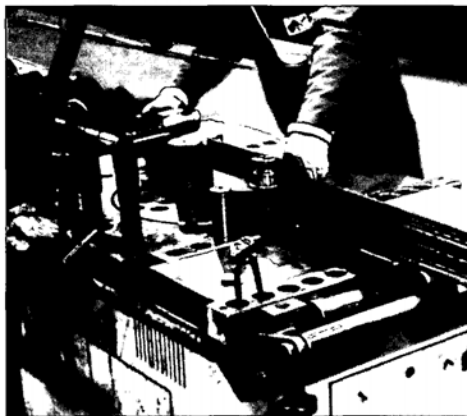
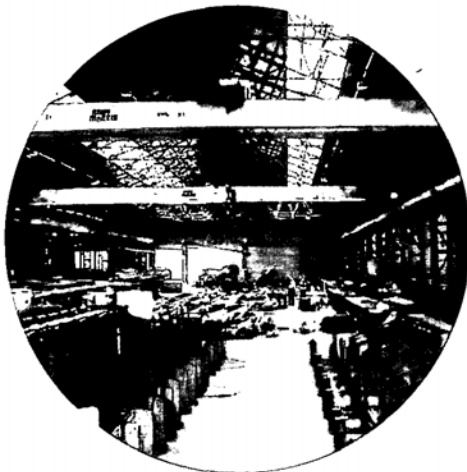

After almost a century as a major manufacturer and distributor of steel reinforcement, BRC are committed and experienced in offering the best combination of quality, price, service and availability.

In recent years, we have absorbed other leading companies such as Spencer Mesh and Square Grip, and this growth, together with the 'partnership' approach we take towards our customers, has been a key factor in our ability to serve a changing industry. We continue to evolve and develop so that we are always able to meet the demands placed upon us.

With a view to further improve our service, we are continually introducing new products. Recent developments include gas protection membranes – for which we offer a design, supply and sub-contract service – all supported by BBA certification and a full installation guarantee.

Speed of construction is always important. We work closely with our customers to provide solutions ranging from prefabricated bar to non-standard fabrics and bespoke accessories. We also work closely with customers to facilitate the electronic transfer of information – including 'SteelPac', a suite of products ensuring seamless data transfer across the entire supply chain from design consultants to the reinforcement suppliers.

Members of our team have worked on construction sites and appreciate and understand the pressures and demands that have to be met by our customers. This empathy enables us to offer suitable solutions to speed construction or assist with temporary skills shortages.

Standard fabric, flying end fabric and specially designed meshes are produced at our two manufacturing plants in the North and South of England, along with our circular spacers and continuous high chairs. The positioning of these two fabric production units ensures quick and reliable distribution throughout mainland UK. We believe that our products, from bar and fabric to wire spacers and other construction accessories, and our services, including prefabrication and contractor detailing, are unequalled in the market.

Having recognised the need for quality assurance throughout our ranges, our company is BS EN ISO 9002 and CARES-approved, and we play a leading role in setting product standards within the industry.

BRC have a nationwide network of strategically located regional businesses, all staffed by people who take pride in our ability to meet the needs of our customers, from the smallest orders to the largest, most prestigious projects, and we are committed to providing our customers with real value for money, whether to a local builder or to a major flooring contractor or civil engineering organisation.

As part of the global Acertec Group, BRC also have divisions specialising in wall reinforcement and insulation (BRC Building Products), tunnelling and ground stabilisation (BRC Weldgrip), and permanent formwork and precast concrete accessories (BRC Special Products).

East Midlands

BRC Mansfield
Tel: 01623 555111
Fax: 01623 440932
Email:
sales@eastmidlands.brc.ltd.uk

North

BRC Barnsley
Tel: 01226 730330
Fax: 01226 771797
Email:
sales@north.brc.ltd.uk

North East

BRC Darlington
Tel: 01325 381166
Fax: 01325 284124
Email:
sales@northeast.brc.ltd.uk

North West

BRC Oldham
Tel: 0161 620 1001
Fax: 0161 620 1660
Email:
sales@northwest.brc.ltd.uk

Scotland

BRC Newhouse
Tel: 01698 732343
Fax: 01698 833894
Email:
sales@scotland.brc.ltd.uk

South

BRC Southampton
Tel: 01794 521158
Fax: 01794 521154
Email:
sales@south.brc.ltd.uk

South East

BRC London
Tel: 020 7474 1800
Fax: 020 7474 8686
Email:
sales@southeast.brc.ltd.uk

South West

BRC Plymouth
Tel: 01752 894660
Fax: 01752 896761
Email:
sales@southwest.brc.ltd.uk

Wales and West

BRC Newport
Tel: 01633 244002
Fax: 01633 265643
Email:
sales@walesandwest.brc.ltd.uk

West Midlands

BRC Birmingham
Tel: 0121 327 0049
Fax: 0121 327 2574
Email:
sales@westmidlands.brc.ltd.uk



the Sign of Quality

The Cement Admixtures Association (CAA) is a trade association founded in the United Kingdom in 1963 to promote and support the effective use of admixtures in concrete, mortar and grout.

Full membership is open to companies who manufacture or supply admixtures for use with hydraulic cement and who have traded in this sector for at least two years. Full members must operate a third party certified quality management system complying with ISO 9001 or ISO 9002, and meet the requirements of the new European Admixture Standard EN 934. They are also required to provide a comprehensive level of technical advice and support.

The CAA provides documented technical information sheets on admixtures and their storage, dispensing, use and environmental impact. Information sheets are also available on admixture selection and use for industrial ground floors. The CAA is pleased to provide help to users through training courses and by giving talks and lectures on admixtures and admixture related subjects.

The Association's full members include all the major companies involved in the development, manufacture and supply of admixtures in the United Kingdom. Several of these companies also have major overseas involvement in admixtures.

CEMENTAID

Cementaid (UK) Ltd

2 Rutherford Way Industrial Estate, Crawley, West Sussex, RH10 2PB
Tel: 01293 447 878 Fax: 01293 447 880 www.cementaid.com



Christeyns UK Ltd

Rutland St, Bradford, West Yorkshire, BD4 7EA
Tel: 01274 393 286 Fax: 01274 309 143 www.christeyns.com



Fosroc Ltd

Coleshill Rd, Fazeley, Tamworth, Staffs B78 3TL
Tel: 01827 262 222 Fax: 01827 262 444 www.fosrocuk.com

GRACE
Construction Products

Grace Construction Products Ltd

852 Birchwood Boulevard, Birchwood, Warrington, Cheshire WA3 7QZ
Tel: 01925 824 824 Fax: 01925 824 033 www.graceconstruction.com



MBT FEB MBT Admixtures

Albany House, Swinton Hall Rd, Swinton, Manchester M27 1DT
Tel: 0161 727 2727 Fax: 0161 727 8547 www.mbtfeb.co.uk



RMC Group PLC

RMC House, Coldharbour Lane, Thorp, Egham, Surrey TW20 8TD
Tel: 01932 568 833 Fax: 01923 568 933 www.rmc-group.com



Sika Ltd

Watchmead, Welwyn Garden City, Herts AL7 1BQ
Tel: 01707 394 444 Fax: 01707 329 129 www.sika.com

Cement Admixtures Association

38a Tilehouse Green Lane, Knowle, West Midlands B93 9EY, UK
Tel/Fax + 44 (0) 1564 776362
E-mail: jmd@btclick.com Website: www.admixtures.org.uk
Contact: John M. Dransfield BSc, FCS

ASSOCIATE MEMBERS

Balmoral Mouldings	Borregaard UK Ltd
Elkem Materials Ltd	Clariant UK Ltd
Synthomer Ltd	Fosroc International Ltd

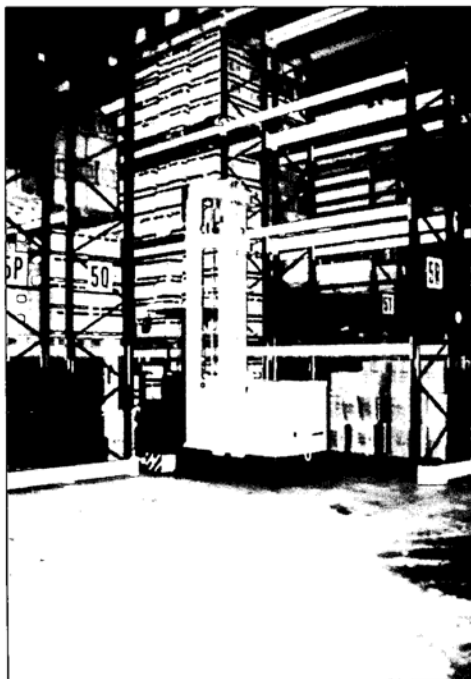

One of the UK's longest established providers of design, consultation and measurement of industrial concrete floors, Combined Flooring Services offers wide-ranging services to cover the many operational requirements of commercial and industrial concrete floors. These services range from advising engineers, mechanical handling equipment suppliers and floor users on the right floor flatness specification to providing guidance and advice to the contractors involved.

Every floor requirement is special and different. Users therefore have an infinitely wide variation of floor surface and flatness requirements. While the choice of specification is paramount for the end user in terms of capital and operational costing as well as long-term use, getting it right from the outset has to be the aim. Getting it right first time will not only save floor users a significant amount of money in the short term, but can result in a decreased potential risk of remedial works in later years of use.

However, floor specification is not always so simple, as initial requirements chosen by a developer do not always meet floor users' needs.

Our case histories have shown that many clients do not need to aspire to ultra high tolerance floors (Superflat or even Category 1), as applications and levels of use do not require that level of precision.

Many of our clients need additional space that may mean using the full height of the building for storage. In these situations Combined Flooring Services will advise on the most appropriate specification. This allows clients to seek more economical floors that suit their specific requirements. For many years this has been the fundamental and common sense approach of Combined Flooring, whose client base includes many worldwide 'blue chip' companies.

SERVICES

- **Floor surveys:** Offering floor surveys to establish compliance to The Concrete Society Technical Report 34 tolerances for defined and free-movement surveys. We may use a floor profileograph, floor scanner or indeed the F-min rig used for the Alternative Measuring System proposed in this latest revision of TR34.
- **Floor grinding:** Floor grinding should only be carried out as a last resort and when deemed necessary to meet the floor user's specific requirements. This can occur in areas of defined traffic where floor tolerances can be critical for the safe operation of VNA trucks. In these situations Combined Flooring Services will carry out grinding services to meet critical tolerances.
- **Consultancy services:** We believe in a policy of full preparation prior to construction. Determining the correct floor design for the application and the correct method of construction is a vital component of the project, where our expertise is invaluable. Supervising the floor as it is constructed is also vital in ensuring that the specified tolerances are achieved. Regular feedback to the contractor allows any required adjustments to be made immediately.

Combined Flooring Services works worldwide to help in the installation of high-quality, fitness-assured floors in France, Germany, Belgium, Spain, Holland, Brazil, Canada, USA, Japan and Singapore, providing a fast response and quick feedback from highly skilled teams. Engineers, floor users, developers and many of the UK's specialist contractors rely on this service.

At Combined Flooring Services, our overriding interest is delivering the best, most economic solution, whoever or wherever our client is.

Combined Flooring Services Ltd

99 Lakewood Road, Chandlers Ford, Eastleigh, Hampshire SO53 5AD, UK

Tel: 02380 262017 Fax: 02380 276162

E-mail: sales@floorsurvey.com

Website: www.floorsurvey.com

Don Construction Products Ltd was founded over 65 years ago and is a long-established UK manufacturer within the construction chemicals market. Our ISO 9001-accredited site in Staffordshire offers state-of-the-art manufacturing facilities.

Specialising in reactive chemical technology, DCP manufacture a comprehensive range of products, including resin and cementitious concrete repair materials, protective coatings, structural grouts and adhesives, waterproofing products and a wide range of concrete admixtures.

DCP also produce one of the largest ranges of flooring solutions by a single manufacturer in the UK today, used in industrial and commercial applications. The range comprises epoxy and polyurethane resin coatings and toppings offering seamless, hygienic, chemical-resistant surfaces with improved abrasion and impact resistance, available in a wide range of colours.

A cementitious pump-applied industrial wearing coat and basecoat system is purpose-designed for the refurbishment of existing internal floors - a fast-track system allowing up to 2000 m² to be applied in one day.

Dry shake flooring systems, spearheaded by TIBMIX, offer the ultimate performance for any new-build project requiring a hardwearing, low maintenance, cost-effective floor, available in a standard range of colours.

All the above are suitable for use in a wide range of applications, particularly areas for production, food processing, warehousing and distribution.

GRIPDECK is a solvent-free polyurethane car park decking system. Offering a highly durable, protective and flexible waterproof membrane, GRIPDECK not only improves the appearance of the structure, but also provides on-going protection against the perils of weathering, carbonation and contaminants.

Cementitious repair mortars offer a complete system solution to cater for small and large-scale concrete repair problems. Using migrating corrosion inhibitor technology, the mortar contains an inhibitor that actively seeks and is absorbed onto the steel layer in reinforced concrete, forming a protective layer and stopping further corrosion and subsequent damage to surrounding concrete. Resin repair materials are designed for specialised repairs where excellent mechanical properties, chemical protection and dynamic loading are key considerations.

Our product range is targeted at the industrial construction and civil engineering markets for both new-build and refurbishment projects, the synergy between industrial and commercial build being common.

Operating nationally throughout the UK, a team of technical sales managers is readily available to offer advice and guidance on product suitability for a given application to clients, specifiers and contractors. This is backed up by a dedicated in-house technical team who are constantly looking at ways of improving product performance and testing new applications demanded by the market place.

Product training and application in the range of products is available locally or at the company's fully equipped training school at the Head Office. Technical seminars can be provided accompanied by practical demonstrations geared to the particular area of interest by the customer.

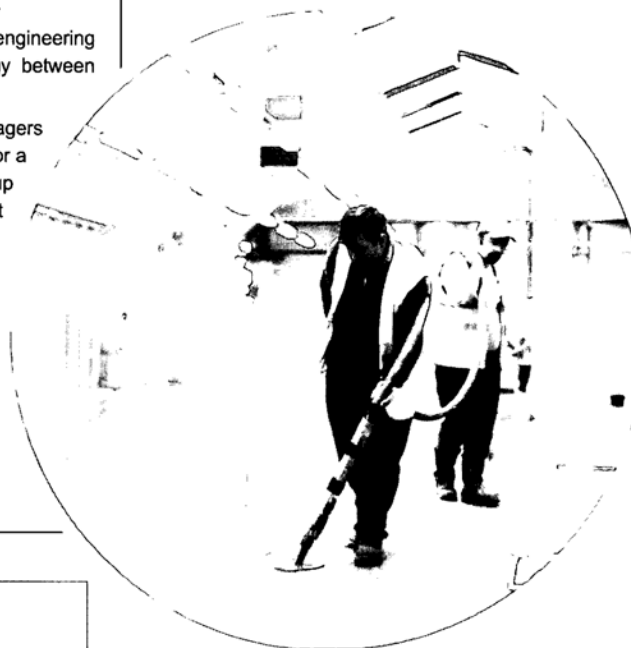

Don Construction Products Ltd

Churnetside Business Park, Station Road Cheddleton, Leek,
Staffordshire ST13 7RS, UK
Tel: 01538 361799 Fax: 01538 361899
E-mail: info@donconstruction.co.uk
Website: www.donconstruction.co.uk
Contact: Lesley Clarke

FACE

CONSULTANTS LTD

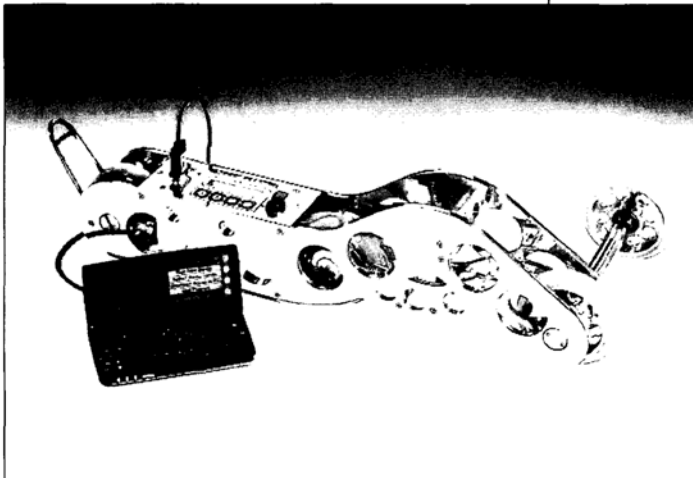

Face Consultants are regarded as the world leaders in the measurement and control of floor profiles. We operate worldwide out of our offices in the UK, USA, Mainland Europe, the Middle East, Asia and Africa.

In 1977 the first Face Floor Profileograph was built. Designed to check floors in narrow aisle warehouses, the self-propelled Profileograph was the first practical instrument for large-scale floor surveys and was the key tool in the development of modern Superflat floor technology.

Today, Face Consultants use the latest in digital measuring equipment, designed and built in-house to check both defined and free movement floors to TR34, DIN, the American F-number systems, and the new wheel-based measurement in the appendix to TR34.

On free movement floors, materials handling equipment is not constrained in the direction of travel and can take an infinite number of paths. These floors are measured in accordance with:

- Concrete Society's TR34 free movement specification – using the Face Propil meter
- DIN 18202 – using the Face DINmeter
- ASTM F number system – using the Face Dipstick.

On defined traffic floors, fork-lift trucks run in fixed paths, such as very narrow aisles. We check these floors' suitability with the Face Profileograph. Like the free movement floors there are a number of differing specifications. The choice of specification is usually geographical:

- UK and areas of UK influence – Concrete Society Technical Report 34
- USA and areas of USA influence – the ACI F-min number system
- Germany and some other European countries – DIN15185.

The self-propelled Face Digital Profileograph can be used to measure to all these specifications by simply changing the rear measuring assemblies: the sensor wheels are set up so they travel in the wheel paths of the fork-lift truck, and produce differential graphs relating to the longitudinal and transverse profiles.

The Profileograph lies at the heart of modern Superflat floor technology. With the Profileograph we can measure a continuous profile of the truck's wheel path and highlight the areas that do not comply with a given specification for corrective grinding.

Our other services include:

- On-site contractor assistance in the construction of Superflat floors.
- Consultation on high tolerance floors
- Bespoke flatness specifications and testing
- Structural investigations, testing and analysis.
- Design and manufacture of flatness testing equipment.

Face Consultants Ltd

Dene House, North Road, Kirkburton, Huddersfield HD8 0RW, UK

Tel: 01484 600090, Fax: 01484 600095

E-mail: info@face-consultants.com

Website: www.face-consultants.com

Contact: Kevin Dare

Fibercon UK is a wholly owned subsidiary of Fibercon International, based in Pittsburgh, Pennsylvania. We have been established in the UK since 1990. A family-owned company, we supply steel fibres globally and have manufacturing plants in China and America. In addition, we are supported in the European market through our German partners.

The past few years have seen significant developments in the design and installation of concrete industrial floors. Steel fibre technology has allowed for alternative design methodology that has provided cost-effective placement solutions for both laser screed flooring technology and traditional placement methods, with durable, fit-for-purpose concrete floors for end users.

Fibercon UK prefer to provide independent design solutions through our specialist structural engineers and are able to offer a complete design package to include drawings, details, site liaison and professional indemnity. We also prefer to work with approved flooring contractors in order that the client/end user can be assured of a quality product from concept to completion. Experience has shown that this is the best approach as the combination of collective expertise undoubtedly removes unnecessary elements of risk and provides reassurance for clients.

We supply both Type 1 (drawn wire) and Type 2 (slit sheet) steel fibres, the type adopted depending on the design criteria. Generally we use the Type 1 (drawn wire) fibres in jointless or piled floors that are based on plastic design methodology and Type 2 (slit sheet) fibres in traditional jointed floors based on elastic design methodology. Type 1 fibres, made from high-tensile cold-drawn wire, provide post-crack residual strength, whereas Type 2 fibres, made from lower tensile cut sheet, provide improved first-crack properties. Both products improve concrete ductility and durability.

Over the years our products have been used in many applications. Undoubtedly our main area of business revolves around the design of floor slabs for a whole range of end uses. Our products have been used in distribution warehousing, cold stores, external hardstandings, multi-storey car parks and many more. We have also gained a lot of experience using microsilica concretes, which have proved very successful in resisting impact and abrasion damage, and improving durability in floors in waste transfer stations and other similar applications where impact and abrasion resistance are the predominant design criteria.

Our aims are to be innovative, but we will never compromise on quality nor exceed the limitations of our products. Fibercon has recently invested in fibre integration machinery in order to effectively disperse our products within the concrete, and we will continue to invest in improving our products and service.

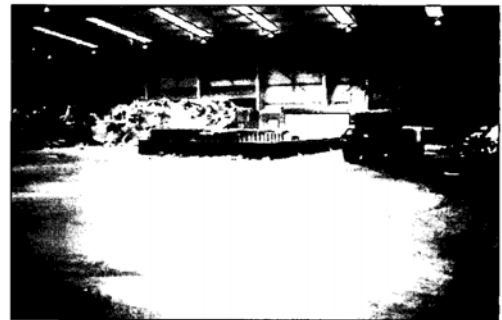

Antiwaste, Norwich: Fibercon fibres were incorporated into microsilica concrete to provide maximum protection against impact and abrasion.

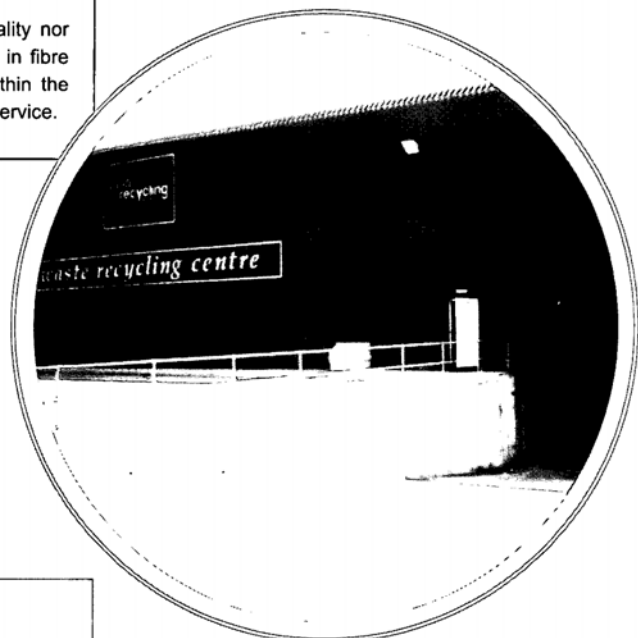

Fibercon UK

Blakes Farm, Parsloe Road, Epping Upland, Epping, Essex CM16 6BQ UK
Tel: 01992890733/4 **Fax:** 01992 890735
E-mail: sales@fibercon.demon.co.uk

FLOORING
SYSTEMS
LIMITED



Sheffield
Ice Arena

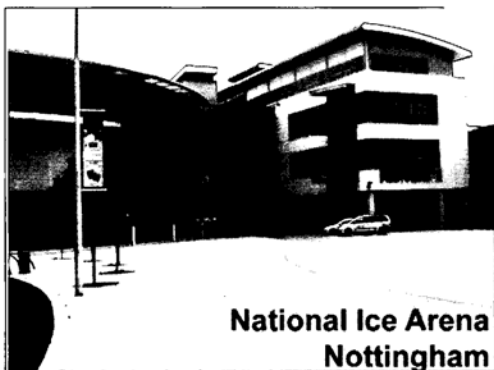

National Ice Arena
Nottingham

Fosseway Flooring Systems Ltd offer a complete service that includes all internal and external screeds, paving and suspended floor areas. Our approach is flexible to suit individual customer requirements. With a highly experienced workforce we are able to work with contractors, structural engineers and groundworkers to achieve and maximise the design in the most efficient way. Where necessary, we are able to adapt our construction methods to achieve specific programme milestones.

Established in 1990, we are conveniently located in the East Midlands, enabling us to offer a full service to the whole of the UK and the Channel Islands. We offer worldwide supervision and consultancy services which have led to completion of successful contracts in places as diverse as Hong Kong, Madeira and Cyprus.

We willingly undertake all manner of projects and are fast gaining a reputation for successfully installing flooring in modern sports stadiums. Such surfaces require very exacting and specific tolerances. These specialist floors have been designed to accommodate the harshest environments with multi-stress requirements. Recent projects include the new National Ice Arena in Nottingham as well as ice arenas in Sheffield, Dundee and Belfast. We have completed numerous sports halls and over 150 bowling centres, all with high tolerance and exacting requirements. In addition to these very specialist floors we are able to install, upgrade and repair floors to all finish and tolerance requirements.

Our workforce of 30 floor-layers each have their own areas of expertise and are supported by some of the most experienced contracts/project managers and surveyors in the industry. We can work as a single unit to achieve very large pour fast-track slabs and equally are able to work as small independent units to suit the smallest of contracts up to the very largest. We work in partnership with the leading manufacturers to offer the latest techniques of dry shake and surface hardener applications.

Being a safety conscious company we own and operate a wide range of plant and equipment that is professionally maintained in house. Each member of staff is regularly trained in health and safety techniques and industry specific training opportunities.

Fosseway have worked closely with the CITB in the development of NVQ level 2 for In-Situ Flooring. We consider ourselves at the forefront of modern-day contracting through the use and ongoing development of our own environmental policies and contract tracking information systems.

Fosseway Flooring Systems Ltd are proud to work with all the respected main contractors and offer services which benefit both contractors and customers alike. Regularly installing 500,000 m² per year, our clients include:

Contractors: Bowmer & Kirkland, Clegg Construction, Clugston Construction, HBG, Wilson Bowden

Customers: Boots, National Health Service, Rolls-Royce plc, Sainsburys, Sport England



Fosseway Flooring Systems Ltd

Unit 6, Winking Hill Farm, Ratcliffe-on-Soar, Nottingham NG11 0DP, UK

Tel: 0115 983 1212 Fax: 0115 983 1412

E-mail: info@fosseway-flooring.com

Website: www.fosseway-flooring.com

GOMACO International Limited was established in the UK in 1983 by GOMACO Corporation, Ida Grove, Iowa, USA as their European sales, service and parts office. GOMACO Corporation is the market leader in the manufacture and supply of concrete slipform pavers and finishers.

This office is now responsible for a network of dealers throughout Europe, Russia, the Middle East and Africa providing support, information and quotations on the complete range of concrete road, airfield, canal and floor building equipment that GOMACO supplies. The product range includes concrete slipform pavers, curb and gutter machines, trimmers and cylinder finishers. It also serves as a liaison point between the dealers, contractors and the main manufacturing site in the USA.

In addition to the sales department there is also a service department based in Slough. Service engineers travel throughout the company's territorial responsibilities commissioning new machines and providing technical support for dealers and customers. If required service engineers and technicians based at the American office are also available.

A unique service that GOMACO provides for clients is GOMACO University. This is a purpose built facility in Ida Grove where training schools are held between January and April each year. Each week a particular machine is covered so contractors can send their personnel to the most suitable course and learn how to run, service and trouble-shoot their machines. The service department also controls the stock of spare parts held in Slough to support machines working in the United Kingdom and throughout its territories. GOMACO's client base is varied from the small 1 or 2-man contractor to large multi-national companies such as AMEC, Balfour Beatty, Bouygues, Dragados etc.

GOMACO machines have been used in many prestigious projects throughout the world including the Channel Tunnel, Charles De Gaulle Airport Paris, M25 Motorway, the Oresund Link, Bluewater Shopping Complex, Japanese High Speed Rail Link, German rail concrete track bed and the first concrete canal to be lined under water.

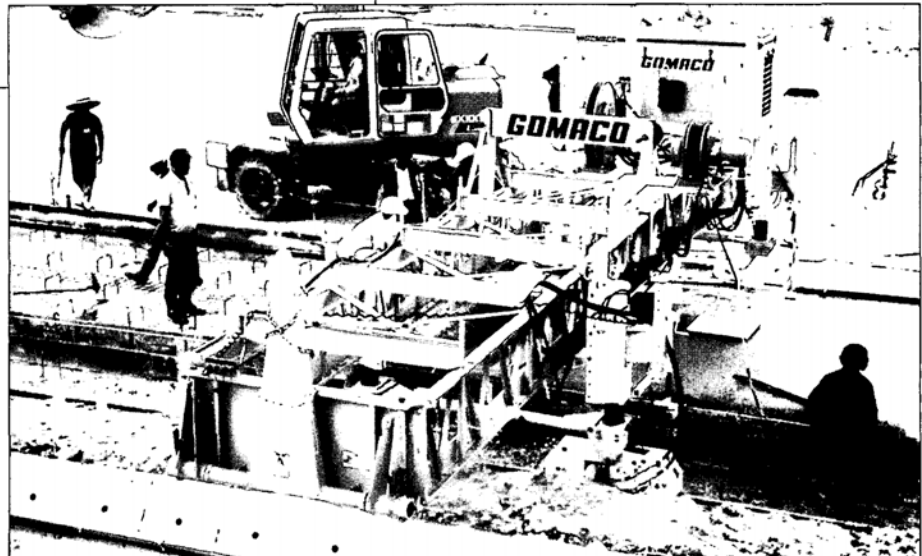
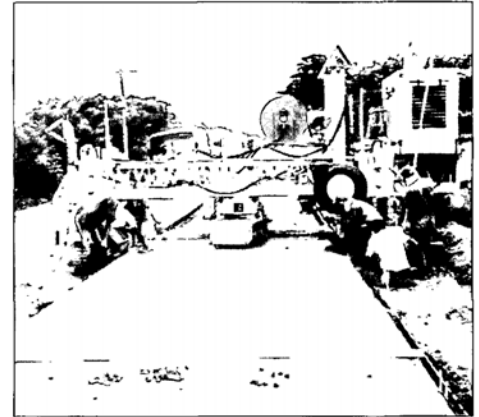

GOMACO International Limited

769 Buckingham Avenue Slough Trading Estate
Slough Berkshire SL1 4NL

Tel: 01753 821926 **Fax:** 01753 693093

Email: pavinguk@gomaco.com

Website: www.gomaco.com

Contact: Rory Keogh – Sales Director

JOHN PYATT CONCRETING LIMITED

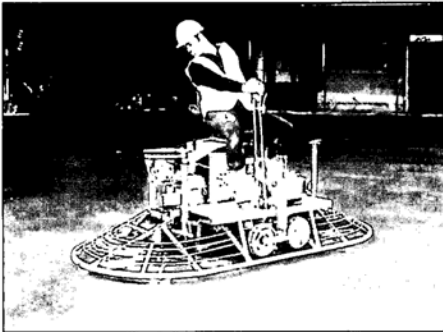

John Pyatt Concreting has built up an excellent track record and reputation in the south of England to become one of the leading specialist concrete floor layers in the UK.

Concrete floor laying is rightly regarded as a specialised art. Few companies can offer the service and high quality finish of John Pyatt Concreting. It is for these reasons contractors like David McLean, Dean & Dyball Construction and Mowlem use the company's expertise nationwide.

John Pyatt Concreting is highly skilled in the laying of high tolerance floors and power floating. During 1999, we installed over 300,000 m² of flooring in a wide range of applications throughout the UK.

To achieve high tolerance floors requires skill and experience. Our Managing Director, John Pyatt, has over 15 years expertise working in the concrete industry, while the company's 40 strong workforce are highly skilled operatives capable of meeting tight deadlines.

Our preferred method of installation is to use the large bay flood pour system, which incorporates hand screeding concrete floor slabs to Category 1 and FM2 tolerance, and is in accordance with The Concrete Society's Technical Report 34 - the industry standard for floor construction.

John Pyatt Concreting has extensive experience in applying dry shake toppings using our mechanical topping spreader. We have become a recognised contractor working with some of the leading suppliers of products in the industry, including Feb, Armorex, Tibmix and Permaban.

We can offer a standard labour and plant option or a full supply package, with or without design service. We can build with many construction systems, including:

- Single and double layer mesh reinforced slabs
- Steel fibre slabs for joint-free and suspended-on-pile applications
- Traditional bar reinforced slabs
- Surface finishes, including mechanically laid dry shake toppings
- Structural screeds

Over the years, the company has consistently achieved standards of flatness required in special buildings such as VNA high-density warehouses, retail units, supermarkets, and industrial and commercial buildings. We can demonstrate through a large number of successfully completed contracts and data that we are able to lay any standard of flat floor.

Recently completed projects include:

- Newbury College for Mann Construction Ltd
- RAF Brize Norton for Buckle & Davis Construction Ltd
- Hum Airport for Woodpecker Properties Ltd

John Pyatt Concreting Ltd

Suite B, 91-92 High Street
Lymington, Hampshire SO41 9AP
Tel: 01590 676585, Fax: 01590 613070
E-mail: jpcltd@hotmail.com
Website: www.jpcltd.co.uk

Kent Wire (Ispat) based at Chatham Docks in Kent is a wholly owned subsidiary of Ispat Hamburger Stahlwerke GmbH, one of Europe's leading wire rod producers and a member of Ispat International. The company imports coil, which is shipped from Ispat Hamburger Stahlwerke to its own quayside for manufacture into fabric reinforcement and cold reduced wire products.

Kent Wire (Ispat) has grown to become the country's leading manufacturer of fabric reinforcement, which it supplies to the construction industry through specialised stockists in the UK and Ireland. It began production in 1988 with an initial capacity of 20,000 tpa and following a £3.5 million investment has increased its manufacturing output to 130,000 tpa.

Wire intersections are resistance welded and the fabric, which conforms to BS4483, is manufactured from cold reduced steel wire complying with BS4482, using the latest computer controlled machinery. All products carry a CARES certificate, an internationally recognised accreditation standard set by the Certification Authority for Reinforced Steels (CARES).

Our fabric products can be readily identified by a unique labelling system, which enables total traceability from pre-rolled coil to finished mesh bundle. These factors, together with our strong relationships with raw materials suppliers, enable the company to maintain a strong emphasis on the high quality and competitiveness of its products.

In addition to the standard range of reinforced fabrics, Kent Wire (Ispat) produces special fabrics according to individual customer specification up to a sheet size of 12 m long x 3.2 m wide, with rod diameters up to 12 mm on 12 mm.

Kent Wire (Ispat) also manufactures cold reduced wire, conforming to BS4482, for supply in layer, wound coil or straight lengths tailored to customer specification. The wire has a specified strength of 460 N/mm² and is available in three profiles – plain round, type 1 indented or type 11 ribbed. Coils can be supplied in weights ranging from 250 kg to 1750 kg, and straight lengths up to 12 m long.

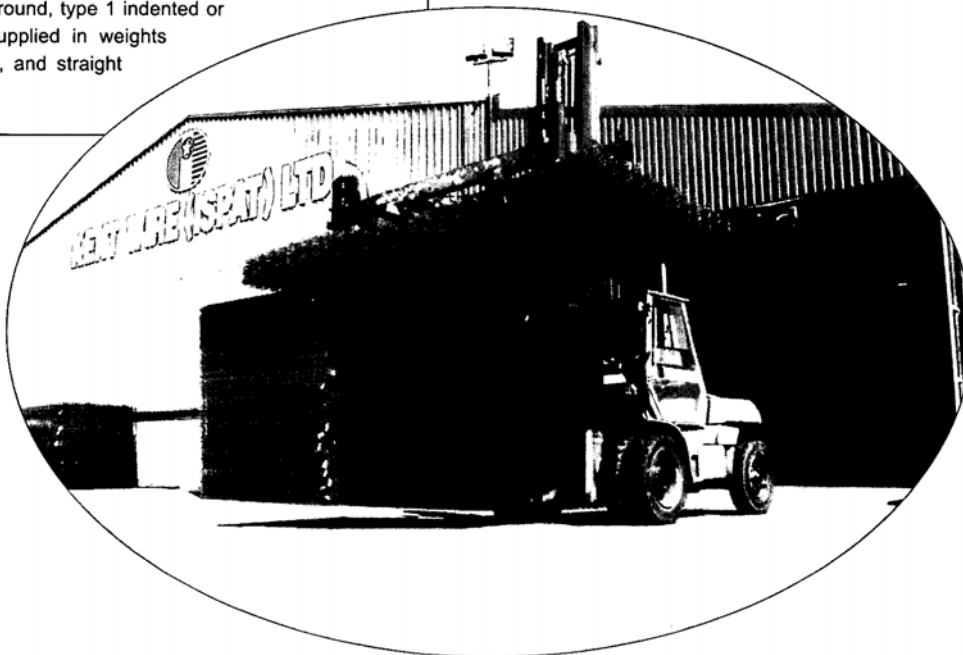

Kent Wire (Ispat) Ltd

Chatham Docks, Chatham
Kent ME4 4SW

Tel: 01634 830964, **Fax:** 01634 830967

Website: www.kwil.co.uk

Contact: Phil Taylor



Based in South Wales, Mike Amodeo (Contractors) reaches across the UK with a fast responsive service to a wide range of different customers and users, providing high quality, high-grade floor slabs from ground floor to the tops of multi-storey buildings.

This specialist contractor, although founded in 1986, originated from a family partnership in 1962. The company has since graduated into a highly competent and competitive organisation with a wealth of experience behind it. As a long-standing supplier, the company has built up a strong relationship with its clients and brings many technical insights that help those clients to overcome their difficulties so delivering the right floor for the work requirements.

Consisting of skilled, trained teams with supporting investment in latest technologies and production plant, Mike Amodeo (Contractors) delivers floor slabs in the range 5000 to 80,000 m², at times delivering up to 3000 m² per day. These same teams will provide highly organised support for main contractors through to design and construct.

With a modern maintenance and storage base in Cardiff, the Company prepares fully ahead of each project to minimise downtime, choosing only certificated concrete producers and materials suppliers for each project.

While Mike Amodeo (Contractors) has high-tech Laser Screed equipment and toppings machinery, the company also delivers wide bay and long strip construction to meet the operational needs of users. Being fully versed in the application of in situ concrete, especially for multi-storey structures, industrial warehouses, retail warehouses and distribution depots, the Company maintains a strong pride in its delivery of quality concrete floors.

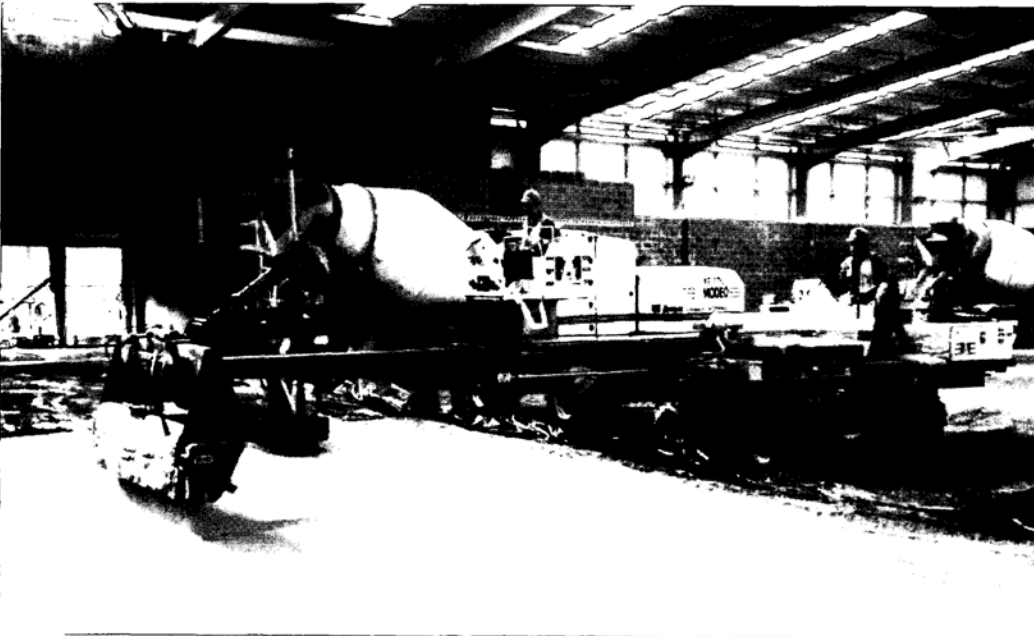

Mike Amodeo (Contractors) Ltd

Block F20, Colchester Industrial Estate
 Cardiff, South Glamorgan CF3 7AP
 Tel: 02920 481778, Fax: 02920 471738
 Email: Michael@mikeamodeo.co.uk
 Website: www.mikeamodeo.co.uk

Permaban specialises in developing new solutions and providing design advice, products and services for concrete floors.

JOINT ARRIS ARMOURING AND LOAD TRANSFER

Free contraction joints (construction joints) are the parts of a floor which break down most frequently. This is recognised in BS 8204: Part 2: 1999. Section 8.5, which requires the designer to consider steel section joint formers for free contraction joints to protect them from damage in heavy duty situations.

Permaban has developed the AlphaJoint system, which armours the joint arris edges with two 10x50mm steel strips. It incorporates the Diamond or Alpha Plate Dowel giving exceptional load transfer with 2-plane joint movement, i.e. normal joint opening and differential lateral movement between adjacent slabs.

Alpha Joint is self-supported, requires no welding, is quick and easy to level and provides a 60 mm lap between 3 m lengths ensuring a straight joint line. Concrete can be placed on both sides of the joint on the same day. Prefabricated corner, T-junction and four-way intersections are also available.

This development is a product of Permaban's metal processing technology, engineering design capability and in-depth understanding of concrete floors. Recognition in the market place has been strong and sustained with Alpha Joint receiving the 2002 SED Award for Innovation in Concrete.

The AlphaJoint is backed up by a full range of floor slab ancillary products including: Permasteel leave-in-place formwork system; StripJoint joint arris armouring and load transfer system for use with timber forms; Permaseal/Permethane concrete curing and floor sealing products; and Permaflex joint sealing and joint arris repair systems.

SPECIALIST FLOORING SYSTEMS

Permashake Dry Shake coloured concrete floor hardeners provide attractive, maintenance free, low cost floors which can be constructed rapidly (e.g. 100,000 ft² retail warehouses in 5 days with 3 days drying period).

Permaban's Contracting Division has its own teams of qualified installers, providing nationwide coverage for installation of:

- Resin coatings, screeds, flow-coats and epoxy terrazzo
- Polymer modified screeds including pumpable, self-levelling and fast-set repair mortars (including cementitious terrazzo)
- Composite flooring

Our clients include all the major retail DIY chains, Warehouse and Logistics Developers and Operators, Food and Pharmaceutical industry, MOD, Engineering, General Construction etc.

FLOOR REPAIRS

Our advice is often requested when a change of use is anticipated or if problems have arisen with existing concrete floors. The contracting division is well equipped and skilled to provide a complete service and offer:

- Concrete floor repair solutions
- Floor flatness tolerance reinstatement
- Joint repair and arris armouring
- Surface abrasion improvement
- Floor maintenance programmes

Permaban have been pleased to sponsor this revision of TR34 and assist in its preparation. We continue to develop and innovate in order to remain a leader in improving the performance and appearance of concrete floors.

Permaban Limited

Mill Close, Lee Mill Industrial Estate, Ivybridge, Devon, PL21 9GL, UK
 Tel : 01752 895288 Fax: 01752 690535
 E-mail: permaban@permaban.com
 Website: www.permaban.com

Permaban

Better Solutions for Better Floors

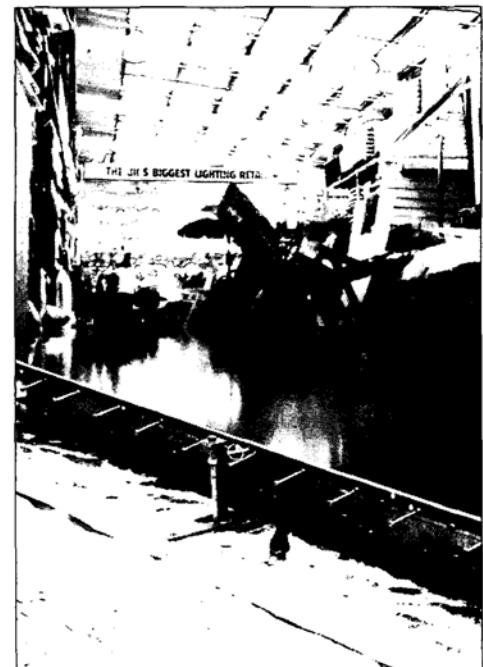

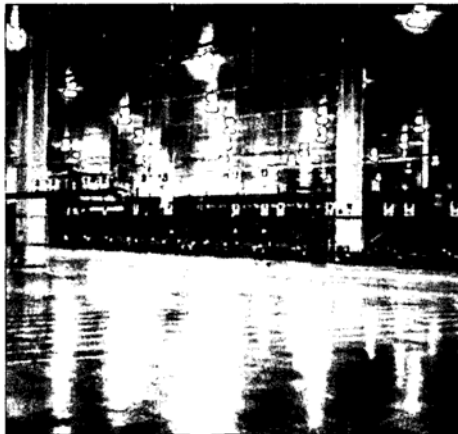

Precision Concrete Floors offer the complete design, supply and installation of new, industrial concrete floors.

The range of services we offer comprise laser screed and hand screeding, superflat floors, suspended floors, upper decks, post-tensioned floors, composite floors, structural screeds and coloured dry shake toppings.

Operating throughout the UK for over 10 years, PCF specialise in the production of specially strengthened concrete floors with ultra-durable surfaces. Such floors are essential in modern warehouses, distribution centres, industrial premises, factories and retail outlets – in fact, in any situation where the concrete floor is subject to continuous foot or wheeled traffic or heavy loads.

The most hardwearing of all industrial floor surfaces are those containing dry shake toppings. These are quartz, mineral or metallic particles that are sprinkled onto the surface of the wet concrete slab, forming a monolithic surface. Dry shake floor surfaces are generally more durable than high strength concrete and provide maximum resistance to continuous abrasion, chemicals, oil and grease, are easy to clean, and are dustproof. Most dry shake products are available in a range of colours and, with special treatment, can be made slip-resistant.

PCF regularly install approximately one million square metres of concrete floor each year, covering a wide range of design, thickness and slab type. The company has invested in the very latest precision equipment including S-240 Laser Screeds, STS-130 Topping Spreaders and a laser-controlled D5M Caterpillar Track Dozer. PCF can now take full responsibility for the preparation of the sub-base and achieve the necessary accuracy required for large bay operations. Using this up-to-date equipment allows up to 4000 m² of concrete floor to be laid each day. Each project is guided by the experienced PCF design and technical team and backed up by directly employed teams of factory-trained operatives.

PCF are the sole UK installers of the unique SILIDUR steel fibre jointless flooring system. By incorporating special steel fibres to reinforce the concrete, floor slabs of up to 5000 m² can be laid without the need for joints. The steel fibre system is now used extensively to replace conventional rebar for suspended floors on piles. The flood pour and Laser Screed process dramatically decreases time over the old rebar system, yet maintains the flatness and accuracy that are demanded by Category 1 tolerance floors.

A large proportion of PCF's work involves the use of the now respected nominally reinforced floor, which incorporates A142 (bottom) mesh, recommended in The Concrete Society's TR34 since its introduction in the late 1980s.

PCF look forward to meeting new challenges in the future and meeting the criteria for flatness and design approaches contained within the new TR34.

Their systems of work allow PCF to install floors for virtually any application, working to the finest tolerances and specifications.

Precision Concrete Floors

Suite 1B, Solent View, Marchwood Industrial Park, Normandy Way,
Southampton, Hampshire, SO40 4PB, UK

Tel: 02380 666400 Fax: 02380 666900

E-mail: admin@precisionconcretefloors.co.uk

Website: www.precisionconcretefloors.co.uk

Silidur was founded in Belgium in 1973 and in the late 1970s was the first company to produce steel-fibre-reinforced concrete floors on a commercial scale.

Silidur (UK) Ltd was established in 1996 and has quickly built a reputation as *the* specialist in joint-free steel-fibre-reinforced concrete floors whether on grade or on piles.

In 2001, Silidur became a member of the Rinol Group. Established in Germany in 1956, and now listed on the Frankfurt stock market, Rinol is the largest European flooring specialist, and the only company to provide a complete flooring package from just one source. From sub-base preparation to 'jointless' concrete floors with in-house dry shake hardeners or resin coatings, with Rinol, you have got it **ALL IN ONE!**

BENEFITS OF THE SILIDUR 'JOINT-FREE' CONCRETE FLOORS REINFORCED WITH STEEL FIBRES

- In-house design
- In-house steel fibres: Eurosteel®, Twincone®, Twinplate®
- In-house Blastmachine to mix fibres evenly on site
- On-site mobile laboratory for concrete quality control
- Can be installed on ground or on piles without any additional traditional reinforcement
- Jointless areas from 1000 up to 4000 m²
- Development of in-house load transfer metallic contract joint
- Can meet UK, US, German and Dutch flatness specifications
- No saw-cut joints = less maintenance, more flexibility, more productivity, long term flatness

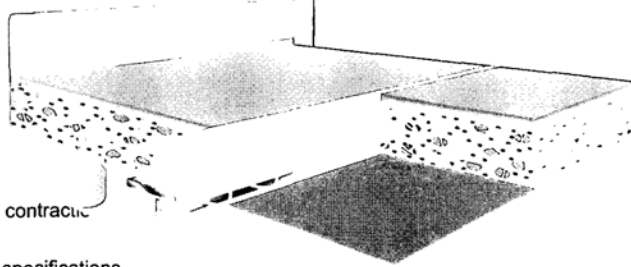

BENEFITS OF RINOLROC SURFACE HARDENERS

- Very cost-effective
- 5 grades of hardeners formulated to meet client's individual wear requirements
- Very hard-wearing, slip-resistant and non-dusting
- Available in a range of colours

BENEFITS OF RINOL RESIN COATINGS

- Resistant to almost all aggressive chemicals
- Meet EU hygiene requirements
- Very hard-wearing, impact- and thermal-shock resistant
- Very easy to clean and maintain
- Available in a range of colours

Whatever our clients require, and wherever in the world, at Rinol, we can provide it all from one single source. No split responsibility!

Our client list is the testimony to the quality and service of our Group: Aldi, Argos, Bestway Cash & Carry, B&Q, Big Yellow, Big W, BMW, Ford Motors, Gazeley Properties, Homebase, Ikea, Interbrew, ProLogis, Rolls Royce, Royal Mail, Tate Modern, TDG, Tesco, Wilkinson...



Silidur (UK) Limited

Ivy House, 23 South Bar
Banbury, Oxon OX16 9AF
UK
Tel: +44 (0) 1295 265200
Fax: +44 (0) 1295 272084
E-mail: info@silidur.co.uk
Websites: www.silidur.com

Silidur (Ireland) Limited

13 Glenview Heights
Mullingar, Co. Westmeath
Ireland
Tel: +353 (0) 44 47147
Fax: +353 (0) 44 84961
E-mail: silidur@eircom.net
www.rinol.com

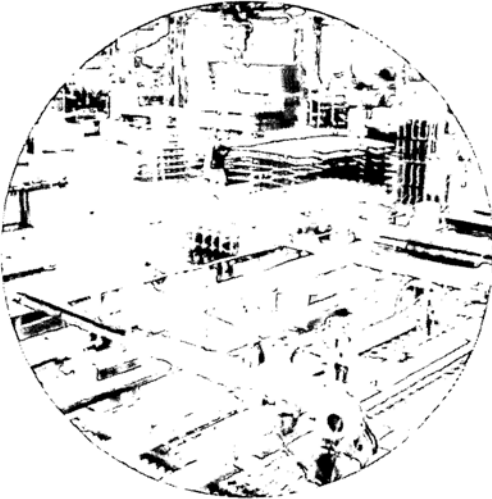

Lichfield fabric manufacturing plant.

ROM is a reinforcement specialist within the construction industry with a national network of manufacturing and distribution plants.

Formed as a limited company in 1926 by the Newman family and based on the River Rom, Rom River traded as a steel reinforcement company. In 1968 Rugby Cement Group PLC bought the company, which they ran until 1997 when a management buyout took place, supported by 3I's and Lloyds Development Capital. With a young board of directors, ROM has progressed from strength to strength with a turnover now in excess of £50 million for ROM Ltd and £8 million for RomTech, a sister subsidiary company specialising in piling. We have a workforce of around 330 people, 50% of whom have been in service for over 20 years.

Supplying projects such as roads, bridges, housing, industrial units, airports, hospitals, offices, schools, water treatment works and many more, ROM offer a full range of services. Apart from our standard range of reinforcement products, we also offer full technical support including:

- Prefabrication into pile caps, beams, columns etc
- Loose rebar conversion to special fabric
- Standard to tailor-made fabric
- Full range of associated accessories
- The revolutionary 'Beamform' permanent shuttering system
- Temporary fencing

Existing clients include O'Rourke, McAlpine, Carillion, Costain Skanska Mowlem, Barratt, Kier, Laing, McLeans, Norwest Holst, Balfour Beatty, Stent, Amec and many more.

At ROM we pride ourselves on continually striving to improve the skills within the organisation and therefore the service provided to our customers.

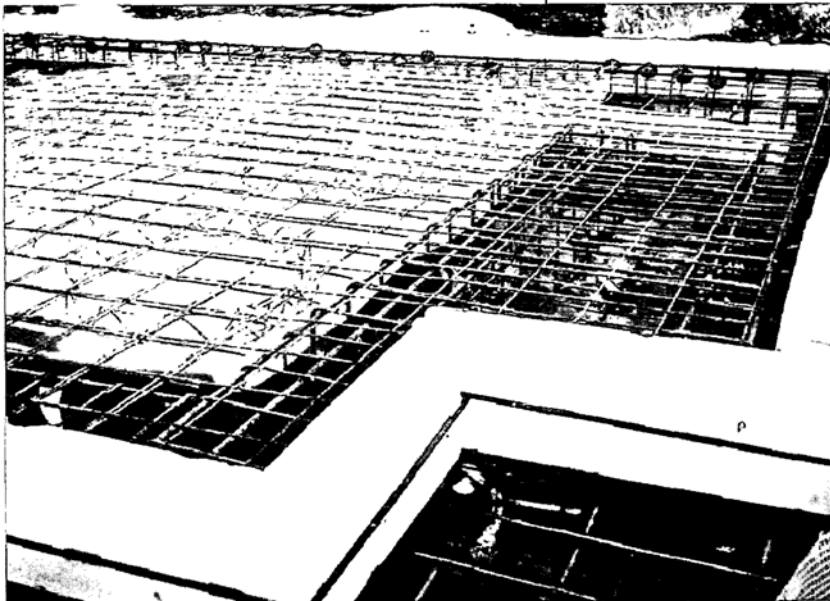

Fabric, prefabricated cages, ring spacers, Beamform

Rom Limited

Eastern Avenue, Trent Valley, Lichfield, Staffordshire WS13 6RN, UK
 Tel: 01543 421680, Fax: 01543 421672
 Website: www.rom.co.uk

Sika Ltd, established in 1927, is the British registered subsidiary of the Sika Group, which has a global turnover of £1 billion. We manufacture and supply specialist construction chemicals, including systems for the improvement and protection of concrete industrial floors.

The range of fully compatible Sika systems incorporates advanced concrete admixtures, including polycarboxylate, melamine and naphthalene-based super-plasticisers, to improve placement and increase early and ultimate strengths. Performance-proven additives are complemented by polypropylene fibres, for shrinkage control and fire resistance, and steel fibres as replacements for mesh reinforcement in jointless floors and for the provision of abrasion resistance.

Newly placed concrete floors can be further improved through the use of Sika fibre-suppressant compounds or the leading quartz, synthetic or metal-based dry shake hardeners and low-odour curing and sealing solutions. Benefits include additional mechanical, impact and chemical resistance together with dustproofing, integral colouring and increased durability. A wide range of products such as cementitious pumped screeds, epoxy resin mortars and coatings, and polyurethane joint sealants supports the core material systems produced for industrial wearing surfaces.

Sika Armorex is registered to ISO 9001/EN29001 for quality control and to ISO 14001 for environmental management. Wherever appropriate, materials conform to European and British Standards and possess British Board of Agrément certification. As an active member of The Concrete Society, ACIFC and FeRFA the company is committed to providing a professional service from project appraisal, specification advice through to on-site support, in order to ensure the success of its systems for concrete industrial floors.

Sika Ltd, global leader and your single source choice for...

- Concrete admixtures
- Fibres for concrete
- Liquid hardeners
- Dry shake hardeners
- Curing compounds
- Jointing systems
- Coatings and toppings
- Roofing membranes

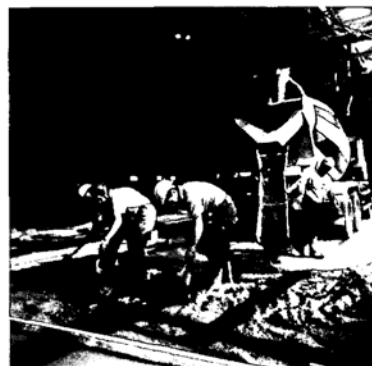
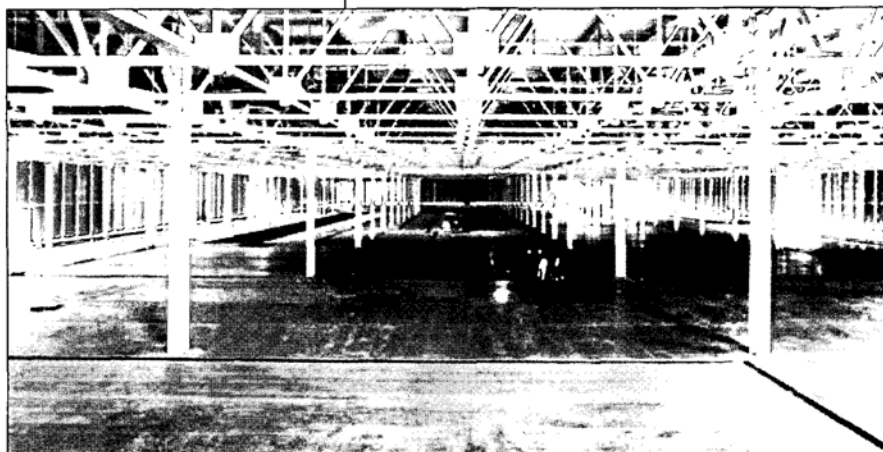

Sika Limited

Watchmead, Welwyn Garden City, Herts AL7 1BQ

Tel: 01707 394444, Fax: 01707 329129

E-mail: sales@uk.sika.com

Website: www.sika.com

Contacts: Laurence McLennan – Sales & Marketing Manager, New Construction
Alex Dennis – Sales & Marketing Manager, Sika-Armorex Flooring



Founded in the 1980s, Snowden Flooring Ltd is a nationwide floor-laying contractor that now lays in excess of 500,000 m² of floors per year. Moving quickly to a position at the forefront of the floor-laying sector, the company has played a leading role in the introduction and establishment of the new Laser Screed technology that has revolutionised concrete flooring construction. The Snowden Flooring plant fleet now includes three Laser Screeds, a dry shake topping spreader, and D5 laser-guided dozer.

Snowden Flooring now concentrates its business on full supply, design-and-build projects. Large, medium-to-high specification laser-screeded floors form the core of the company's work, and floors of up to 50,000 m² have been completed for such clients as B&Q, Homebase, Wincanton, Scottish & Newcastle Breweries, and Toyota.

The company employs a workforce of up to 55 trained and skilled floor-laying specialists, many of who have been with the company for a decade. Site supervision and control are provided by a hierarchy of site engineers and foremen, thereby ensuring that each aspect of the construction process is strictly monitored, and that the company's over-riding commitment to producing a quality end product is achieved.

The company has recently moved into new purpose-built premises in Featherstone, West Yorkshire. Conveniently situated for the M62 and M1, the site contains offices for estimating, operations and accounts, and a 1000 m² warehouse for plant maintenance and materials storage. This relocation reflects both the company's sustained success, and its continuing commitment to greater efficiency.

For a flooring contractor with a modern, professional approach, combined with a friendly and personal service, choose Snowden Flooring.

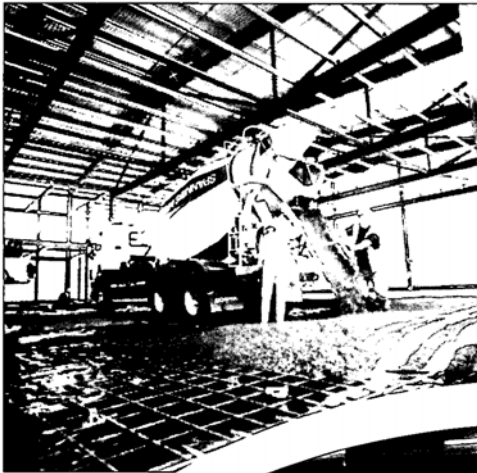

Snowden Flooring Ltd

Unit 1, Green Lane Industrial Park, Green Lane, Featherstone,
West Yorkshire WF7 6EL, UK
Tel: 01977 696050, Fax: 01977 695051
E-mail: snowdenflooring@ukonline.co.uk
Contact: Mr Pat Snowden

Of all the inventions over the last 20 years, the one that has arguably revolutionised concrete floor construction most is the Laser Screed. First sketched as an idea in 1983, today there are in excess of 1200 machines in use in over 30 countries. Combined, they are responsible for screeding in excess of 100 million square metres of concrete a year.

Now owned by the multi-billion dollar Dover Corporation, Somero Enterprises has its headquarters in Jaffrey, New Hampshire, USA. In addition to our manufacturing facility in Houghton, Michigan, Somero maintains its European sales office and support centre in Chesterfield, UK.

The original S-240 Laser Screed is now employed in a range of machines to suit the individual contractor's needs. Mounted on a four-wheel-drive all-wheel-steer chassis is a rotating upper platform with a telescopic boom supporting the screed head assembly. Using a laser transmitter as a reference source, two receivers mounted on each end of the screed head coupled with the machine's on-board automatic control system allow the concrete to be cut and screeded to a constant and precise level.

In 1993, the first Somero STS Topping Spreader joined the Laser Screed. This finally allowed the accurate application of dry shake toppings. Combined, these machines now form the foundation of modern concrete industrial floor construction.

Our innovation continues with the recent introduction of a walk-behind laser-guided screed - the CopperHead. Designed for the smaller floor and difficult to access areas, the benefits of mechanised large bay construction are now available on any size of job.

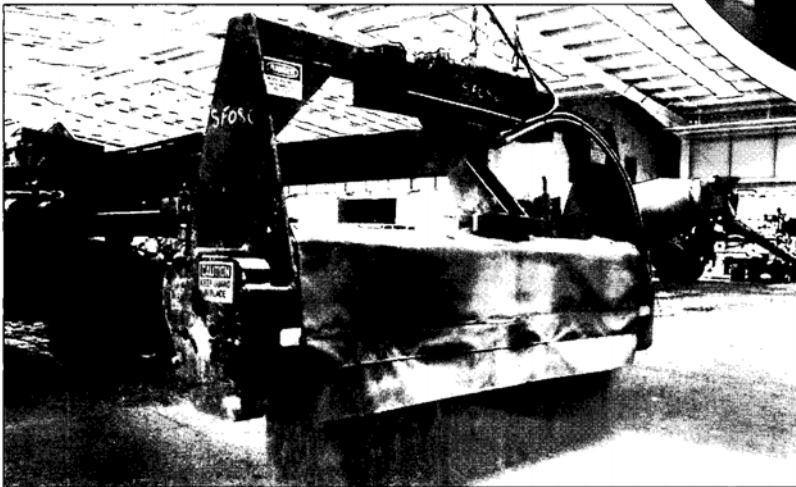
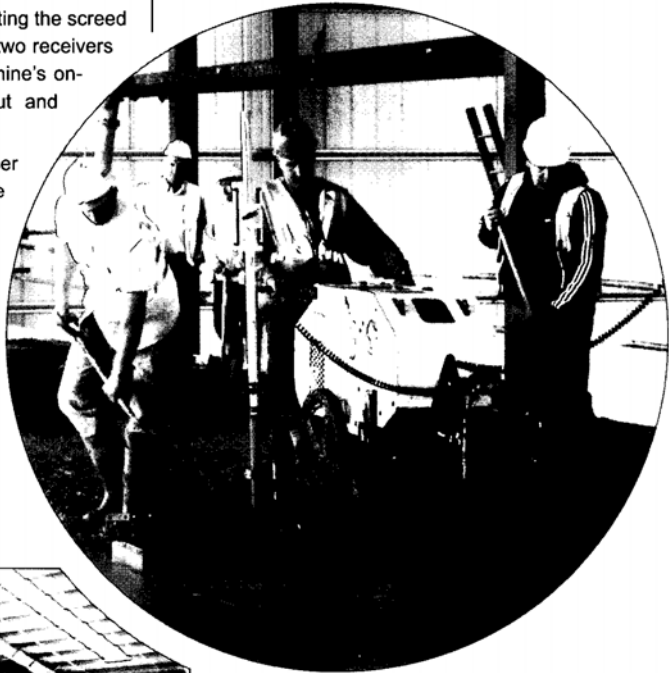

Somero Enterprises Ltd

Broombank Road, Chesterfield Trading Estate, Chesterfield,
Derbyshire S41 9QJ, UK

Tel: 01246 454455, Fax: 01246 261673

E-mail: somero-uk@somero.com

Website: www.somero.com

Contact: Andrew Keen - Sales Director

STANFORD

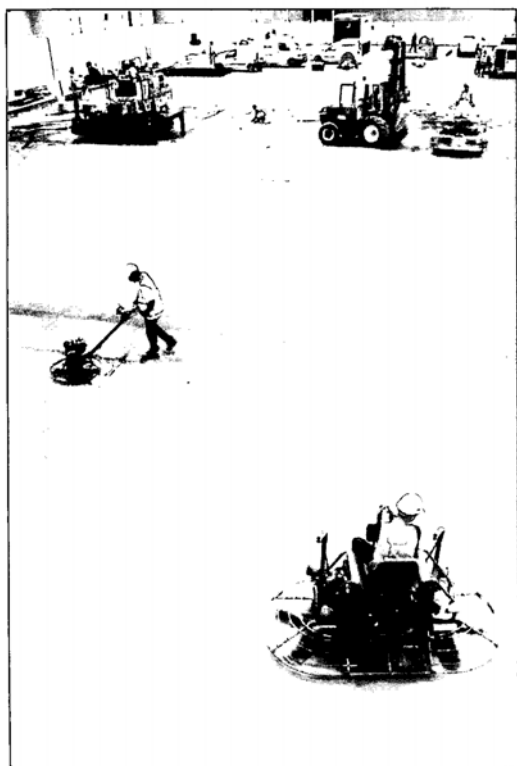

Stanford is a key provider in the design and construction of high-quality concrete floor slabs both in the UK and overseas. Innovation, design and construction excellence, added to top quality management and total commitment to each and every project, are the hallmarks of our reputation.

Founded in 1982, Stanford today provides industrial concrete floors for warehousing, retail and distribution facilities including high flatness tolerance and pile-supported applications. A key proponent for the adoption of increased performance standards combined with unique techniques and working practices has ensured that we provide competitive high quality floors to programme.

Stanford can provide the full range of flooring types including:

- Steel-fibre-reinforced concrete (SFRC) construction
 - Pile-supported slabs
 - Joint-free pours
 - Nominally reinforced jointed slabs
- Steel fabric and/or traditional bar reinforced construction
 - Pile-supported slabs
 - Nominally jointed slabs
- Automated application dry shake topping flooring systems
 - Coloured architectural systems
 - Fibre suppression properties
- Laser screed high quality, high output techniques
 - FM2 and FM2 (special) tolerances
 - Cat 1 VNA flooring system

We have constructed these flooring systems for clients such as Adidas, AGR, Argos, ASDA, Aston Martin, B&Q, BAe Airbus, Big W, Brake Bros, Bridgestone, David Lloyd Fitness Centres, Fed Ex, Focus DIY, Ford, GAP, Gillette, Hayes Distribution, Healthcare Logistics, Honda, JJB Sports, Land Rover, Lidl, Makro, Matalan, MFI, Pilkington, Poundland, ProLogis, Royal Mail, Sainsbury's, Somerfield, TDG Logistics, Tesco, Tibbett & Britten, TK Maxx, Toyota, Vauxhall and Volvo Trucks.

Stanford uses up-to-date technology and the best products available to design and construct floor slabs. This includes dry shake topping materials, steel aris protection jointing systems, plate dowel load transfer systems and specialist gas membrane and venting schemes. Each sector of the project can be tailored to meet specific client requirements or specification.

With all construction, on site quality is paramount. Recognising this, we provide a professional team both at pre-award and during construction. All construction is managed and supervised by experienced personnel responsible for quality, health and safety and the efficient running of the project. In fact, many senior management positions within Stanford are held by personnel with significant site experience who are fully aware of the requirements on site for a high quality project.

Working with partners abroad Stanford is also equipped to provide the high level of quality and efficiency in construction and project management expected in the UK, overseas. Stanford can provide the full design & build service to clients with projects from Ireland to Asia using experienced UK labour and UK construction techniques, making high quality floors possible in all global facilities.

Stanford Industrial Concrete Flooring Ltd

5 Richmond Street South, West Bromwich, West Midlands B70 0DG

Tel: 0121 522 2220 Fax: 0121 522 2020

E-mail: sales@stanford-flooring.co.uk

Website: www.stanford-flooring.co.uk

Contact: Kevin Louch - Technical Director kevin@stanford-flooring.co.uk
John Brough - Senior Estimator john@stanford-flooring.co.uk

Almost ten million square metres of industrial ground floors are laid annually in the UK. And one in every five of these square metres is the work of Stuarts Industrial Flooring, a 400% increase over the last 15 years.

This specialist construction group has led concrete floor construction since it pioneered granolithic flooring, a world-beating combination of granite and cement, some 160 years ago.

In the last 20 years, however, the rapid growth in demand for distribution centres and warehousing has led to a transformation in construction methods and design criteria to provide high levels of output. Stuarts has built a business based in three centres - Birmingham, Boroughbridge and Edinburgh - to become the UK market leader in modern industrial flooring construction.

Traditionally Stuarts produced a wide variety of products, from precast architectural work to prestressed beams and fireproof concrete stairs and floors. Today its core business is in direct-finished concrete floors and external hardstandings, ground-suspended floors and mezzanine decks. The recent relocation of the company's Birmingham facility has enhanced the backup, from design and construction planning through to careful site co-ordination, management and operation, which underpins our expertise.

From 60,000 m² distribution depots to mid-range warehousing, from mezzanine flooring to small storage facilities, Stuarts has a reputation for fast, efficient and competitive construction, all with the same careful control of quality.

Clients rely on Stuarts to provide a successful floor solution, based on the 'right first time' philosophy. From pre-contract meetings to final sign-off, the company maintains a strong partnership with customers and suppliers - a partnership that also includes extensive aftercare.

Stuarts has the versatility to provide design-and-construct and fast-track packages to fit particular needs or to fulfil the design requirements of clients' consultants. We also draw out the most economical construction process to match the project requirements. By using innovations in construction methods and plant, Stuarts ensures that clients benefit from more efficient, more economical construction.

To maintain its market leadership, we have a strong rolling investment programme in its 200-strong team and in new plant and techniques - including £1 million worth of high-output laser screed spreading and compacting machinery. This has allowed the company to meet the most demanding of challenges - a contract which required over 100,000 m² of finished floor, on four levels with a two-storey office attached, to be completed in just six weeks.

David Harvey, Joint Managing Director of Stuarts Industrial Flooring, affirms: "We are investing for the long term. We are sure that the market is ready to move towards sustainability objectives, building and costing floor construction for life. This of itself will bring further benefits in terms of quality of construction and client satisfaction for purpose."

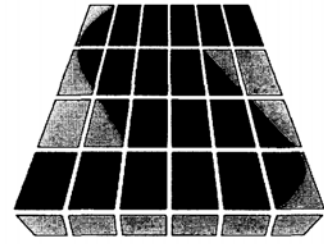

Stuarts
Industrial Flooring Ltd.

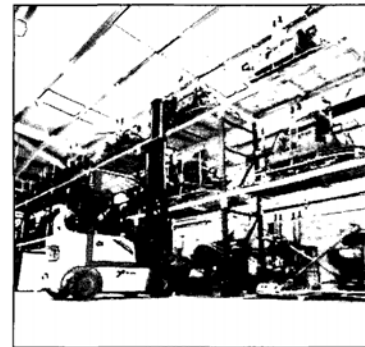

Stuarts Industrial Flooring Ltd

Trinity Road, Kingsbury Link
Tamworth, Staffordshire
B78 2EX, UK
Tel: 01827 871140 Fax: 01827 871155
E-mail: sales@stuartsflooring.co.uk

Scotland Office

Stuart House, Dryden Vale
Bilston Glen, Loanhead
Midlothian EH20 9HN, Scotland
Tel: 0131 440 4000 Fax: 0131 440 2772
E-mail: stuarts@stuarts-ed.flooring.co.uk

Northern England Office

Stuart House (Unit 1)
Becklands Close, Roecliffe
Boroughbridge, Yorkshire YO51 9NR, UK
Tel: 01423 326111 Fax: 01423 326222
E-mail: terry@stuartsflooring-northern.com

Website: www.stuarts-flooring.co.uk

PROPEX

CONCRETE SYSTEMS

Propex Concrete Systems Ltd. (known as Synthetic Industries Europe Ltd. until February 2006) was formed in 1985 as a subsidiary of the American SI® Corporation, to promote and develop the use of its market leading brand of Fibermesh® polypropylene fibres for concrete reinforcement in the UK and Europe. As a group the company operates today from nine manufacturing facilities and employs more than 2,800 people worldwide.

The early acceptance of Fibermesh® fibres in the UK by consultant engineers, contractors and ready mixed concrete suppliers led to the rapid expansion of business throughout Europe, Africa, Middle East and Asia where our products are now sold through a network of strategically placed distributors.

In the following years, we pioneered the development of multi-filament and anti-microbial fibres as well as introducing degradable bag packaging for ease of addition to concrete mixers. Our market leading brand of Fibermesh® monofilament and fibrillated fibres are British Board of Agrément accredited.

Our acquisition of Novocon® Steel fibres, in 1998, created a unique single source for concrete fibres and led to the formation of SI® Concrete Systems, which is specifically focused on offering innovative and unbiased solutions for the fibre reinforcement of concrete. Following a merger in February 2006, the company became Propex Concrete Systems.

Our range of Fibermesh® polypropylene fibres are employed to control early cracking and to improve the overall durability qualities of concrete, whilst Novocon® steel fibres provide concrete with long-term durability and toughness in high stress applications.

Key application areas include in-situ and precast concrete for roads, dams, bridges, tunnels, offices, retail and commercial buildings. They are also used extensively in concrete screeds/overlays, refractory products and sprayed concrete but our primary market of emphasis remains concrete floor slab construction where our materials are widely accepted as high quality solutions. Major customers in these areas include British Airways, BMW, Caterpillar, Coca-Cola, Ford, Honda, Nestles, Pro-Logis and many more.

Propex Concrete Systems employs specialists from our target markets and reinforcement engineers who specialize in fibre technology thus enabling us to offer a higher level of support and service to our customers. Our engineers are able to assist with industrial floor slab designs, utilizing advanced computer design technology and provide problem-solving cost effective solutions tailored to individual projects.

Our commitment to innovation is highlighted by our fibre concrete technology team, which is conducting in-house research in addition to funding major research projects at selected universities around the world in an effort to develop new solutions for concrete reinforcement.

Results of this research include ENDURO® (High Performance Polymer) fibres used in sprayed concrete/ slab construction and NOVOMESH® a combined fibre reinforcement system for which Propex Concrete Systems, as a manufacturer of both steel and polypropylene fibres, leads the world.

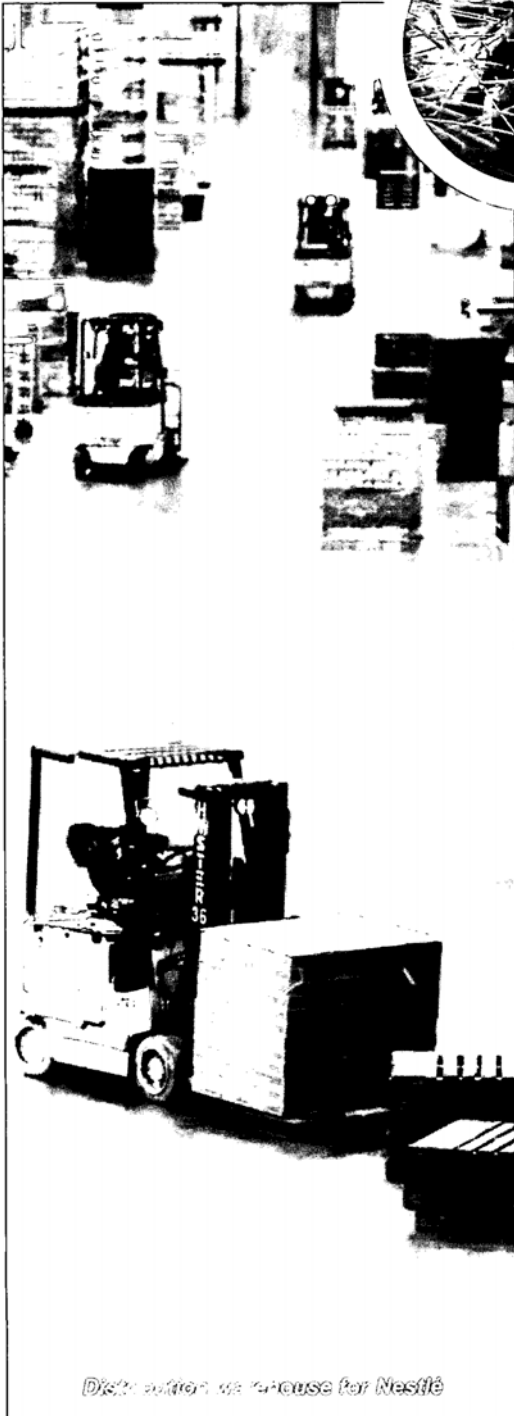
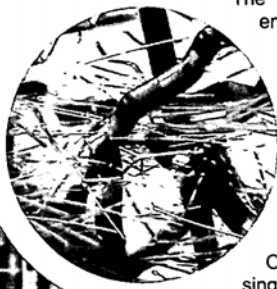

District action warehouse for Nestlé

NOVOCON



Propex Concrete Systems Ltd

Propex House, 9 Royal Court, Basil Close, Chesterfield, Derbyshire, S41 7SL, UK

Tel: + 44 (0)1246 564200, Fax: + 44 (0)1246 564201

E-mail: enquiries@propexinc.co.uk

Website: www.fibermesh.com

Twintec Ltd continues to make its mark on the UK market as "Leaders in Steel Fibre Reinforced Concrete Technology". The Rugby-based company was formed in 1997 as a UK subsidiary of the Luxembourg-based Twintec International group. Our aim is to promote the development and use of advanced steel fibre reinforced concrete (SFRC) technology within the construction industry.

The Twintec International team has been at the forefront of steel fibre reinforced concrete technology since 1980, and currently produces 2 million square metres of concrete industrial flooring each year. With an annual group turnover of around £50 million, Twintec follows clients worldwide, and has produced floors from Korea to Canada.

SERVICES

Twintec is a specialist company offering complete design, build and insured guarantee solutions for steel fibre reinforced jointless floors.

We produce large area floor panels of up to 3000 m² with no sawn induced contraction joints. This eliminates curling problems and reduces long term repair and maintenance costs.

Our techniques and skilled workforce enable Twintec to produce floors to the very highest flatness tolerances without resorting to remedial grinding, including Category 1, FM2 & FM2+.

Compared to traditional design methods, the use of our proven technology can allow a substantial reduction in floor thickness for even the most extreme loads.

The commercial team at Twintec are happy to enter into very early negotiations with fund holders or their project teams and to provide design information, proposals for flatness and finishes and of course accurate budget quotations. This service is available free of charge.

We are pleased to provide design and build rates for concrete industrial floors, ground bearing or suspended on piles, for any project in the UK or overseas.

DESIGN

In addition to ground bearing slabs, we are able to offer design solutions for ground floor slabs suspended on piles. In addition, we can provide solutions for complex foundations to meet particular site challenges. Finite element analysis is used to determine our designs for structural applications.

Twintec designs are produced in house by an experienced team of engineers and are covered by our professional indemnity insurance to the value of five million pounds (Policy No. BB981130PI). Furthermore, we offer a comprehensive insured guarantee for the entire flooring system in terms of design, materials and workmanship and also consequential loss insurance up to a value of six million pounds.

Twintec's floor laying teams produce floors throughout Europe, using various national standards for measuring floors. This experience provides our company with genuine understanding and detailed knowledge of what our clients really need.

Our web site provides examples and details of our work, together with a detailed analysis of the methods we use to produce high quality industrial flooring.



Twintec Ltd

Cottage Leap, Rugby, Warwickshire, CV21 3XP, UK
 Tel: 01788 567722 Fax: 01788 567700
 E-mail: mail@twintec.co.uk
 Website: www.twintec.co.uk

INDEX

A

abrasion xiii, 16, 84
abrasion resistance 5, 27, 72, 73
 aggregates 72, 73, 75
 curing 72, 73, 74
 dry shake finishes 72, 73, 77
accelerating admixtures 76
adjustable pallet racking 13
admixtures 70, 71, 75–76, 77, 82
aggregate interlock xiii, 4, 42, 43, 44–45
aggregates 70–71, 72, 73, 75
 see also fine aggregates; surface aggregates
air-entraining admixtures 76
aisle widths
 counterbalance trucks 16
 see also critical aisle width; racking; very narrow aisles
anchorage fittings 46
appearance 28, 30, 77
armoured joints xiii, 16, 45–46, 84, 102

B

back-to-back racking 13–14, 57, 93–94
bar racks 13, 15
bar reinforcement *see* steel reinforcement bars
baseplates 13, 15, 57, 94–95
 see also point loads
bearing and bending capacities, dowels 61
block stacking xiii, 12, 59–60
bump cutting xiii, 10, 11
bursting 44, 45, 61, 62

C

California bearing ratio xiii, 34
cantilever racking 13, 15
cement 74–75
cement content 4, 5, 70, 71, 72, 73
chairs, reinforcement 39
changes over time, surface regularity 25
chemical resistance 1, 27–28, 72–73, 85
clad rack structures 15–16
classification
 abrasion resistance 27
 joints 40
 loads 3, 17–18
 surface regularity 22, 23, 24, 26, 99
cleaning 84
cold stores
 concrete maturity 69
 floor construction 11
 joint sealants 48, 85

 joints 41, 47–48
 pre-construction planning 81
 sub-bases 35
colour 28, 77
combinations of point loads 57–58
combined shear and bending, dowels 61
compressive strength 69
concentrated loads *see* point loads
concrete 52, 54, 69–77
 see also steel-fabric-reinforced concrete; steel-fibre-reinforced concrete; synthetic-fibre-reinforced concrete
consistence 71–72
construction *see* floor construction; site practice
construction joints 40
contaminated sites 35, 36
converting to defined-movement specifications 23, 25–26
corner loading 44, 56–57, 58, 64
counterbalance trucks 1, 2, 16, 17, 18
crack inducers 40
cracks and cracking 4, 28
 jointless floors 10
 large area construction 10
 maintenance 85
 microfibre-reinforced concrete 77
 pile-supported slabs 52, 102
 sawn joints 70
 steel-fabric-reinforced concrete 3–4, 37–38
 steel-fibre-reinforced concrete 38
 yield line pattern 55
 see also crazing; mid-panel cracking
cranes 13, 17, 18
crazing xiii, 28, 71
 see also cracks and cracking
creep factor 64
critical aisle width 59
critical perimeter 61, 62, 63, 94, 103–104
curing and curing compounds 70, 71, 74–75
 abrasion resistance 72, 73, 74
 good site practice 82
 surface finish marks 30
curling xiii, 4–5, 25, 28, 65, 70
 see also drying shrinkage

D

damage 84
datum xiii, 20, 22, 23
day joints 40
defined-movement areas 20, 21

 converting/upgrading to 23, 25–26
 definition xiii
 joints 25
 surface regularity 21–22, 23–25, 97–99, 100
 see also very narrow aisles
deflections 25
 checking 52, 63–64, 95–96
 dowels 61–62
 joint design to minimise 44
 steel-fibre-reinforced beams 38
 see also modulus of subgrade reaction
delamination xiii, 5, 29, 76
design briefs 2, 9, 90–91
design equations 56–60
design moment capacities 56
differential settlement 33–34
dominant joints xiii, 4, 37, 41, 47
dormant joints, definition xiii, 47
dowels
 definition xiii
 free-movement joints 40, 41
 load-transfer calculation 60–62
 load-transfer capacity 44, 45
 steel fabric reinforcement 38
drive-in/drive-through racking 14, 21
dry shake finishes 76–77
 abrasion resistance 72, 73, 77
 colour and appearance 28, 77
 definition xiii
 mix design 71
 protection of new floors 82
 surface fibres 29–30, 77
drying shrinkage 64, 65, 70, 75
 see also cracks and cracking; curling
dual point loads 58
ductility
 definition xiii
 microfibre-reinforced concrete 39, 77
 steel-fabric-reinforced concrete 4, 38, 103
 steel-fibre-reinforced concrete 4, 38, 69
 synthetic-fibre-reinforced concrete 4, 69
dynamic loads 4
 aggregate interlock 45
 joint performance 44
 machinery subject to vibration 13
 materials handling equipment 16, 23
 partial safety factors 54

E

early thermal contraction *see* thermal contraction
edge loading
 design equations 56–57, 58, 64

design example 93, 95, 103, 104
 effective depth 62
 effective dowel numbers 60
 elastic solid model, soil behaviour 33
 elevational differences xiii, 19–20, 22–23,
 24–25, 97–99
 equivalent flexural strength 38
 expansion joints 41
 expansive cements 75

F

fibre-reinforced concrete *see* microfibre-reinforced concrete;
 steel-fibre-reinforced concrete; syn-
 thetic-fibre-reinforced concrete
 fillers 42, 49
 fills 35
 fine aggregates 71, 72, 75, 77
 fixed equipment and machinery 13
 fixing 46
 flatness xiii, 19, 20, 97
see also surface regularity
 flexural strength 38, 52, 69, 102
 flexure, design for 51
 floor classification *see* classification
 floor construction 9–11, 82
see also jointless floors; joints; large area
 construction; long strip construction
 fork-lift trucks *see* trucks
 formed free-movement joints 10–11, 41,
 46, 47, 84, 102
see also armoured joints
 formed joints
 classification 40
 definition xiii
 large area construction 23
 long strip construction 23, 47
 narrow aisle warehouses 46
 performance 40, 42–44
 surface regularity of free-movement areas
 23
 formed restrained-movement joints 42, 47
 free-movement areas 16, 20, 21
 definition xiii
 joints 23
 large area construction 10, 23
 long strip construction 23
 surface regularity 21, 22–23, 97, 100
 free-movement joints 40–41
 cold stores 47
 definition xiii
 floors for pallet trucks 16
 load-transfer capacity 44
 pile-supported slabs 102
 trafficked areas 42
see also formed free-movement joints
 front and lateral stackers *see* stacker trucks
 frost resistance, sub-bases 35

G

gas membranes 36, 82
 global safety factors 54

grinding *see* remedial grinding
 ground-supported slabs *see* slabs

H

health and safety 81, 82
 heater mats 11, 35
 'hedgehogs' 77
 high-range water-reducing admixtures 76,
 77
 horizontal loads *see* line loads

I

impact damage 84
 imported fills 35
 induced joints 40
see also sawn joints
 inductive guide wires *see* wire guidance
 systems
 information sources 105
 insulation *see* thermal insulation
 internal loading
 bending moments 53
 design equations 56–57, 58, 64
 design example 93, 95, 103, 104
 internal partition walls 13, 94
 isolation details xiii, 40, 42, 43, 46

J

joint fillers 49
 joint layout 9, 11, 46–47, 102
 joint mechanisms *see* dowels; steel fabric
 reinforcement
 joint openings 44–45, 46
 cold stores 47
 curling 5
 floors for pallet trucks 16
 formed free-movement joints 10
 sawn restrained-movement joints 42
 steel-fabric-reinforced concrete 37
 joint sealants 23, 48–49, 84–85
 joint spacing 3–4, 16, 39, 46–47, 102
 jointless floors 47
 armoured joints 46
 definition xiii
 design example 92–96
 for pallet trucks 16
 formed free-movement joints 47
 large area construction 10
 pile-supported slabs 11, 102
 steel-fibre-reinforced concrete 10, 38,
 47
 joints 9, 40–49
 curling and 4–5
 defined-movement areas 25
 definition xiii
 floor surfaces for trucks 16, 17
 free-movement areas 23
 large area construction 10, 46–47
 load-transfer capacity 4, 44–45, 47, 93,
 95, 102
 long strip construction 10–11, 47

maintenance 23, 49, 84–85
 pile-supported slabs 102
see also dominant joints; sawn joints

L

large area construction xiii, 9–10, 23,
 37–38, 46–47
 levelness xiii, 19, 20
see also surface regularity
 limit values *see* tolerances
 line loads xiii, 13, 14, 15, 58–60, 94
 live storage systems 14
 load-carrying capacity 16, 44
see also California bearing ratio; ductility
 load classifications 3, 17–18
 load-transfer calculation 60–62
 load-transfer capacity 5
 definition xiii
 joints 4, 44–45, 47, 93, 95, 102
 steel-fabric-reinforced concrete 38, 45
 steel-fibre-reinforced concrete 45
see also shear capacity
 load-transfer mechanisms 40, 41, 42,
 44–45, 46
 design considerations 4, 52
see also aggregate interlock; dowels
 loads 12–18, 53–54
 design example 92, 103–104
 dominant joint formation 4
 dowels 61–62
 locations 56–57
see also corner loading; dynamic loads;
 line loads; point loads; wheel
 loadings and contact areas
 long strip construction xiii, 3–4, 10–11, 23,
 47
 long-term drying shrinkage 64, 65
 long-term settlement 17, 33–34
 Los Angeles coefficient 75

M

maintenance 23, 49, 84–85
 man-down/man-up trucks 17
 materials handling equipment 16–17,
 20–21, 95, 97–100, 104
 mature concrete, cold stores 69
 membranes 4, 36, 82
 mesh *see* steel fabric reinforcement
 mezzanines xiii, 15, 54, 94–95
 microfibre-reinforced concrete 39, 77
 mid-panel cracking
 steel-fabric-reinforced concrete 3–4, 37,
 38, 42, 45, 47
 thermal contraction 70
 mix design 71–72, 76, 77
 mobile pallet racking 14
 modulus of subgrade reaction xiii, 33–34,
 35, 53, 54
 moisture movements 4
 movement accommodation factor xiv, 48
 movements 4, 64–66
 multiple point loads 58

N

narrow aisle warehouses 11, 46
see also very narrow aisles
 nominal loads 1, 12–13
 non-compliance *see* tolerances
 notifiable wastes 35

P

pallet racking 13, 14
 pallet trucks 1, 16
 panel, definition xiv
 partial safety factors 13, 54
 partition walls 13, 94
 performance
 concrete 27, 69–73
 joints 9, 23, 40, 42–44, 45–46
 see also deflections; load-transfer capacity
 performance factors 9
 perimeter *see* critical perimeter
 permissible limits *see* tolerances
 pick-and-deposit stations 14
 pile-supported slabs 4
 construction 11
 definition xiv
 deflections 25
 design 52, 101–102
 steel-fabric-reinforced concrete 101
 steel reinforcement bars 37, 101
 planning 81–82
 plastic shrinkage 64, 71, 77
 plate dowels 45
 plate-loading tests 34
 point loads xiv, 13–17, 25, 55, 57–58
 polluted sites 35, 36
 polypropylene microfibre reinforcement 39, 77
 post-construction activities 83
 power finishing
 abrasion resistance 72, 73
 air-entraining admixtures 76
 chemical resistance 73
 crazing 28
 definition xiv
 plastic cracks 71
 slip resistance 29
 pre-construction planning 81–82
 procurement methods 3
 profileographs 24, 25, 97, 98
 properties, surface regularity xiv, 19–20, 22–24, 97, 98
 protection
 new floors 82–83
 see also abrasion resistance; armoured joints; chemical resistance
 punching *see* bursting
 punching shear 52, 62–63, 93, 101, 102, 103–104
 push-back racking 14–15

Q

quadruple point loads 58

R

racking xiv, 2, 13–15, 93–94, 103
see also back-to-back racking; clad rack structures
 racking end frames xiv, 13
 racking layouts, undetermined 21–22, 23
 racking leg loads, design equations 57
 radius of relative stiffness 53, 54, 93
 rail guidance systems 17
 rail-mounted equipment 13, 14, 17, 18
 reach trucks 1, 16–17
 reinforcement 4, 5, 37–39, 82
see also steel fabric reinforcement; steel fibre reinforcement; steel reinforcement bars
 remedial grinding 5, 24–25, 27, 100
 conversion to defined-movement areas 23, 25–26
 definition xiv
 resilience modulus *see* modulus of subgrade reaction
 restrained-movement joints xiv, 3–4, 38, 40, 41–42
see also formed restrained-movement joints; sawn restrained-movement joints
 restraint stresses 65–66
 retarding admixtures 71, 76

S

safety 81, 82
 sampling, elevational differences 22, 24
 sand
 sub-bases 35
 see also fine aggregates
 sawn free-movement joints 40–41, 44
 sawn joints
 classification 40
 cracks beneath 70
 definition xiv
 free-movement areas 23
 long strip construction 10
 performance 40, 42–44
 sealants 49
 steel-fabric-reinforced concrete 37, 38
 see also dominant joints; dormant joints
 sawn restrained-movement joints 42, 44
 cold stores 47
 construction procedure 82
 floors for pallet trucks 16
 large area construction 10, 46
 load-transfer mechanisms 42
 long strip construction 47
 maintenance 84
 steel-fabric-reinforced concrete 38, 42, 45
 scouring and impact damage 84
 screed rails 10, 11
 sealing 28, 42
see also joint sealants
 serviceability 52, 63–66, 102
 serviceability limit state 54
 settlement 17, 25, 33–34
 shear capacity
 dowels 60–61
 see also load-transfer capacity; punching shear
 shear studs 46
 shrinkage 46, 65, 69–71, 76
see also cracks and cracking; drying shrinkage; plastic shrinkage
 shrinkage movements 4
 shrinkage-reducing admixtures 70, 76
 single point loads 57–58
 site practice 81–83
 slab span, pile-supported slabs 101
 slab stiffness 53
 slab thickness 1, 5
 design example 92–96, 103–104
 effective depth 62
 modulus of subgrade reaction 33, 34
 radius of relative stiffness 54
 sub-base top surface tolerances 35–36
 uniformly distributed loads 12–13
 wire guidance systems 17
 slabs xiv, 9–11, 16, 46, 50–66
see also pile-supported slabs
 slip membranes xiv, 4, 36, 82
 slip resistance xiv, 29
 slump 71
 soils, sub-bases and membranes 33–36
 sources of information 105
 spacers, reinforcement 39
 spacing *see* joint spacing
 specification, concrete performance 69
 stacker cranes 13, 17, 18
 stacker trucks 17, 18, 57
 static lean 21
 static loads 4, 12–16, 45, 54
see also line loads; point loads; uniformly distributed loads
 steel armouring *see* armoured joints
 steel fabric reinforcement 37–38, 47, 52–53, 82
 steel-fabric-reinforced concrete 3–4, 37–38
 critical shear perimeter 63
 design example 103–104
 design moment capacities 56
 joint spacing 3–4, 39
 joints 37, 41, 47
 load-transfer capacity 38, 45, 62
 partial safety factors 54
 pile-supported slabs 101
 sawn restrained-movement joints 38, 42, 45
 steel fibre reinforcement 38, 101
see also surface fibres
 steel-fibre-reinforced concrete 38
 critical shear perimeter 63
 design example 92–96
 design moment capacities 56
 ductility 38, 69
 effective depth 62
 flexural strength 38, 52
 jointless floors 10, 38, 47
 large area construction 10
 load-transfer capacity 45
 mix design 71, 77

on-site addition of fibres 82
 partial safety factors 54
 pile-supported slabs 101–102
 wire guidance systems 38, 77
see also surface fibres

steel reinforcement bars 37
 critical shear perimeter 63
 design moment capacities 56
 formed restrained-movement joints 42
 installation 82
 partial safety factors 54
 pile-supported slabs 101, 102
 properties 53
 tied joints 42
 wire guidance systems 17, 37

storage racking *see* racking

sub-bases 5, 35–36
 checking 82
 definition xiv
 dominant joint formation 47
 joint spacing 46
 pre-construction planning 81
 subgrades xiv, 33–35, 81
 surface aggregates 29
 surface fibres 29–30, 77
see also steel fibre reinforcement

surface finish marks 30
 surface grinding *see* remedial grinding

surface regularity 19–26, 83, 97–100
 definition xiv
 floors for stacker trucks and cranes 17
 formed joints 44
 induced joints 40
 large area construction 9–10
 long-term settlement of subgrades 33
 very narrow aisles 3, 17
see also curling

surface requirements 16, 17, 27–30, 77, 91
see also abrasion resistance; chemical resistance; cracks and cracking; crazing; curling; delamination;

surface regularity
 surface wear 16, 84
see also abrasion resistance

surveying
 soils 34
 sub-base finish levels 36
 surface regularity 22–23, 24, 25–26, 83, 97–99, 100

suspended slabs *see* pile-supported slabs

synthetic fibre reinforcement 39
 synthetic-fibre-reinforced concrete 77
 critical shear perimeter 63
 design moment capacities 56
 ductility 4, 69
 mix design 71
 properties 52

T

tangs xiv, 46
 thermal contraction 47–48, 64–65, 70–71
 thermal insulation 11, 35
 thermal movements 4

thickness
 sub-bases 35
see also slab thickness

tied joints xiv, 40, 41, 42, 102

tolerances
 elevational differences 22, 23, 24–26, 97–99, 100
 sub-base surfaces 35–36

toughness xiv, 38
see also ductility

toxic wastes 35

trimming, sub-bases 35

trowel marks 30
 trowelling *see* power finishing

trucks 16–17, 18, 57, 95, 99–100

two-layer construction 11

U

ultimate limit state design 51–52, 54
 uniformly distributed loads xiv, 12–13, 58–60, 94

unit loads 12, 59–60
 unit loads *see* block stacking

upgrading to defined-movement specifications 23, 25–26

V

value for money 2
 vapour resistance, slip membranes 36
 very narrow aisle trucks *see* stacker trucks
 very narrow aisles 3, 14, 17, 18, 23, 57
see also defined-movement areas; narrow aisle warehouses

W

water-reducing admixtures 70, 76, 77
 water/cement ratios 70, 71, 72, 73, 77
 wearing surface, definition xiv

welded steel fabric reinforcement *see* steel fabric reinforcement

wheel loadings and contact areas 16, 17, 57, 95

wide aisles 16–17
 wide bay construction 11
 Winkler model, soil behaviour 33
 wire guidance systems 17, 37, 38, 41, 59–60, 77

workability 71–72, 74
see also water-reducing admixtures

Y

yield line theory 55–56, 101

Concrete industrial ground floors

A guide to design and construction

Report of a Concrete Society Working Party

Successful concrete floors are the result of an integrated and detailed planning process focussing on users' needs to deliver completed projects at acceptable and predictable cost - that is, to give value for money. As demand for distribution, warehousing and retail facilities continue to rise, the size and performance requirements for floors for them have also increased. However, constant development and innovation in design, materials and construction have kept pace with the demands made.

This Report - which is the result of a thorough review of all aspects of floor design and construction by a multi-disciplinary team of engineers, contractors, materials specialists and users - gives comprehensive guidance on design and construction of concrete ground floors for industrial use. The review has led to significantly better guidance on thickness design. Surface regularity requirements have been reviewed in detail in the wake of new survey work. The guidance on concrete specification now reflects current thinking on materials and construction practice. Where possible, the guidance in the Report is non-prescriptive, to allow designers and contractors to use their skills to develop economic solutions for particular performance requirements.

Intended primarily for designers and consultants, it will also be invaluable for contractors, and owners and users of industrial facilities.

Preparation of this Report has been jointly funded by the Department of Trade and Industry under the Partners in Innovation scheme, and by industry, through the Association of Concrete Industrial Flooring Contractors, which also provided significant technical input.

ISBN 1 904482 01 5



THE CONCRETE SOCIETY

Riverside House, 4 Meadows Business Park, Station Approach,
Blackwater, Camberley, Surrey GU17 9AB

Tel: +44 (0)1276 607140, Fax: +44 (0)1276 607141

Email: enquiries@concrete.org.uk; www.concrete.org.uk